

# **ELECTRICAL COMMUNICATION**

**ITT**

VOLUME 39 • NUMBER 2 • 1964

# ELECTRICAL COMMUNICATION

Technical Journal Published Quarterly by

INTERNATIONAL TELEPHONE and TELEGRAPH CORPORATION

320 Park Avenue, New York, New York 10022

President: Harold S. Geneen

Secretary: John J. Navin

## CONTENTS

---

Volume 39	1964	Number 2
This Issue in Brief .....		170
Recent Achievements .....		174
Ministac—a Versatile Method for Constructing Component Assemblies by <i>H. T. Prior</i> .....		190
Standard Equipment Practice for ITT Europe by <i>F. Beerbaum, J. Evans, and F. Leysens</i> .....		199
Central Testing Organization Within ITT Europe by <i>C. A. Meuleau</i> .....		212
Speech Immunity of Push-Button Tone Signaling Systems Employing Tone Receivers with Guard Circuits by <i>L. Gasser and E. Ganitta</i> .....		220
Quasi-Electronic Telephone Switching System HE-60 by <i>H. Schönemeyer</i> .....		244
Harmonic Absorbing Filters in Waveguide by <i>J. Paine and H. S. V. Reeves</i> .....		260
Evolution of Telephone, Telegraph, and Telex Traffic by <i>E. M. Deloraine</i> .....		265
Spectral Matrix for Analysis of Time-Varying Networks by <i>Carl Kurth</i> .....		277
Coded-Linear-Array Antenna by <i>Frank S. Gutleber</i> .....		293
Choice of a Telephone Switching System by <i>E. M. Deloraine</i> .....		305
World's Telephones—1962 .....		314
United States Patents Issued to International Telephone and Telegraph System; November 1962–April 1963 .....		321
Notes		
Book: Halbleiter (Semiconductors) .....		173
Kramar Receives Pioneer Award .....		198

---

Copyright © 1964 by INTERNATIONAL TELEPHONE and TELEGRAPH CORPORATION

EDITOR, Harold P. Westman

Subscription: \$2.00 per year

ASSISTANT EDITOR, Melvin Karsh

50¢ per copy

## This Issue in Brief

**Ministac—A Versatile Method for Constructing Component Assemblies**—Ministac was developed to fill the need for a simple, reliable, and robust method of constructing modular assemblies of conventional components, including combinations of these components with thin-film circuits and semiconductor circuits. Ministac is suitable for mounting on assembly boards manufactured in accordance with the standard equipment practice for ITT Europe.

The components are arranged in a rectangular stack. The most-important feature lies in the use of punched metal strips to provide all the interconnections among components, plus integral tags to which the components are directly soldered or welded.

Manufacture of the punched interconnections is carried out by a punched-tape-controlled machine. This permits economical manufacture of a variety of metal strip patterns in small to medium quantities. Support for the punched interconnections is provided by insulating moldings to which they are attached in a simple way.

The design and fabrication of models, using hand tools, is simple and convenient.

The electrical properties and the interconnection and packaging facilities of Ministac cover the bulk of requirements up to at least 100 megahertz.

**Standard Equipment Practice for ITT Europe**—A standard design is to be widely used within the ITT system for the construction of electronic units and their assembly in racks, sub-racks, or cabinets, unless special requirements prevail. The design represents the consensus of an international team and has thus benefited from the experience of a number of our European companies.

The work covers a complete equipment practice comprising the connector, the assembly board that mounts the connector, the subrack supporting the boards, the rack for mounting the subracks, and the enclosure of the complete

installation. Such features as screening, wiring guides, and designation of parts are included.

Dimensions and construction details can be standardized for a wide range of communication and electronic equipment. Particular attention has been given to manufacturing problems.

**Central Testing Organization Within ITT Europe**—The increasing need for standards of high quality and uniform test specifications led ITT Europe Technical Headquarters to create the Central Testing Organization, starting in 1959. The operating rules generally include the preparation of common (ITT Europe) test specifications and agreement on their use.

The 10 existing test centers and their activities are described. They concern, respectively, selenium and silicon power rectifiers; relays; capacitors; transistors and diodes; magnetic materials and cores; vacuum tubes; resistors, thermistors, and varistors; connectors; and microelectronic devices. Emphasis is placed on life, reliability, mechanical, and climatic tests, the comparison of products of different origins, and accelerated test methods of determining parameter drifts.

**Speech Immunity of Push-Button Tone Signaling Systems Employing Tone Receivers with Guard Circuits**—An important problem in push-button signaling systems using voice frequencies is the protection of the signal tone receivers from interference by noise, speech, and music. These can enter the telephone microphone in the intervals between push-button actuations, appear in the subscriber circuit, and reach the tone receivers. This interference may result in imitated calling signals unless protective measures are taken. Depending on the method chosen, the character of such measures may be quite different.

A method is described that effectively solves the problem with the aid of guard circuits in the tone receivers. The speech immunity depends not only on the characteristics of the guard circuit, but also on the effects of a number of

other parameters investigated. It was found that the following four parameters had the greatest effects: (1) location of the signal frequencies in the voice-frequency band, (2) number of signal frequencies and signal-frequency ratios, (3) sensitivity of the guard circuit and effect of the guard factor, and (4) type of code used.

For highest speech immunity, the signal frequencies should be located in the upper part of the voice-frequency band; the calling tone should comprise not fewer than two discrete signal frequencies; the frequency ratios of the signal frequencies should avoid musical combinations; and the guard factor should not be made too small. A 2-group code was found to work best.

The number of signal imitations regarded as tolerable is discussed. It was assumed that the optimum number, with reference to the subscriber, is lower by one order of magnitude than the number of disturbances caused by other sources while a connection is being established.

Variations of the proposed system have been investigated and the test methods and results are described.

**Quasi-Electronic Telephone Switching System HE-60**—A trial office was placed in operation in Stuttgart in July 1963, to test the HE-60 quasi-electronic switching system.

Only dry reed (Herkon) switches and electronic active components are used. A multistage register-controlled link arrangement is used in this space-division system. The markers are subdivided into individual units performing special tasks.

A guide-wire method is used for route finding in the switching network. An offering signal is fanned out over all free links to the called line. One of these paths is selected by an accepting signal. This permits finding even the last available path.

System reliability is assured by duplicating the markers and introducing a number of test and

monitor procedures. All assemblies are of the plug-in type.

**Harmonic Absorbing Filters in Waveguide**—The input mixer in a microwave repeater produces modulation products  $mf_r \pm nf_{io}$ , where  $f_r$  is the received super-high frequency and  $f_{io}$  is the local-oscillator frequency ( $f_r + 70$  megahertz).

Resonance can occur at  $f_r + f_{io}$  between the mixer and another waveguide component and also between any two waveguide components. This causes group-delay distortion that creates unwanted noise in the system, since  $f_r + f_{io}$  recombines with  $2f_{io}$  to give 70 megahertz.

The purpose of the sum-frequency-absorbing filter is to absorb  $f_r + f_{io}$  with no reflection and to present a match with negligible loss at  $f_r$ , thus eliminating distortion effects.

The absorbing filter in ridged waveguide is also described for use where there is a requirement to absorb higher frequencies than  $f_r + f_{io}$ .

**Evolution of Telephone, Telegraph, and Telex Traffic**—Extrapolation of past evolution permits operating administrations to forecast the growth of their telecommunication traffic. The stimulation from new developments such as direct dialing, wide-band transoceanic cables, and future artificial satellites must be considered.

The evolution curves are shown to be approximately exponential; that is, the growth rates are constant. Telex traffic is enjoying exceptional growth, followed by telephone traffic, which is also increasing substantially. Telegraph traffic rate of growth is generally stationary or declining slightly, except in countries having poorly developed or greatly expanding telecommunication facilities.

Intercontinental traffic is expanding most rapidly, followed by international and internal traffic in that order. Many graphs substantiate these trends.

Graphs of telex traffic evolution exhibit a knee toward 1955. Unanticipated modification of the

growth rate is one of the hazards of forecasting by extrapolation. A reduction of the growth rate for intercontinental telex traffic is likely in coming years.

With foreseeable telephone and telex annual growth rates as high as 20 and 46 percent, respectively, operating administrations must plan network modifications and extensions far in advance. Failure to keep pace will result in lost revenue and stunted economic growth.

**Spectral Matrix for Analysis of Time-Varying Networks**—In contrast to time-invariant networks, no systematically integrated theory exists for time-varying networks. Nevertheless such networks have become increasingly important lately and they are finding many applications in practical engineering, particularly in parametric amplifiers and in resistance and reactance modulators.

For the analysis of time-varying networks, a method is devised based on an approach known from the theory of time-invariant networks. By expansion of the concept of the iterative matrix to a "spectral matrix," an analysis of individual time-variant networks in the frequency domain and a subsequent arbitrary interconnection become possible, so that the spectral matrix of the composite network is obtained by simple operations of the matrix calculus. This allows a calculation of the time- and frequency-dependent transfer function and of all other quantities of interest on four-poles. The method is especially useful for calculating such networks using electronic computers.

**Coded-Linear-Array Antenna**—A direct, relatively simple procedure determines precise array-antenna code spacings that can reduce side lobes by any desired degree. The procedure does not involve a complex set of equations; it uses a general equation which, with repeated application, can force nulls at any desired value of the antenna space angle. The process has direct and complete control over every null or zero position in the complete antenna pattern

and therefore can not only achieve reduction of side lobes, but can reduce them wherever desired. This permits a pattern with the lowest lobes adjacent to the main beam. Superposing the array pattern on that of the primary radiators would then tend to result in a final over-all antenna pattern that approaches the optimum.

The proposed design procedure can be accomplished using antenna elements with equally weighted or coded amplitudes. Either approach permits easier implementation and higher power capability than techniques employing uniform spacing with amplitude taper.

**Choice of a Telephone Switching System**—The telephone subscriber no longer distinguishes between local and long-distance calls with regard to speech quality and switching time. He would prefer to dial a minimum number of digits and enjoy various other telephoning conveniences such as handsfree operation. The operating authority looks for economy, flexibility for future expansion, adaptability to all the augmented services that the subscriber will be willing to buy, reliability, alternative routing for peak loads, and automatic accounting and billing. The manufacturer requires that designs be evolutionary, to reduce manufacturing costs and increase quality and reliability. To satisfy national interests, the manufacture, installation, and maintenance of equipment with personnel having limited skills must be envisaged in its design.

The number of digits that must be dialed is affected by how many small areas have their own minimum-digit numbering plans. Each will need a toll code for the national network and if several of these are combined into a single numbering area, the maximum number of digits for the national network may be reduced.

Direct switching, in which each digit as it is dialed actuates one switching stage, is simple, but if a path to the next stage cannot be found in the time before the following digit is dialed, the call is lost. Indirect switching employs a register in which the dialed digits are stored to

control the switching train, with time being available to hunt for alternative routes around busy stages.

The up-and-around switch used in step-by-step systems and the rotary switch are being replaced by the crossbar switch, which uses precious-metal contacts having sufficiently short

travel to greatly reduce operating time. Combined with fast tone signaling, selecting time has been shortened from seconds to milliseconds. The crossbar switch may be used with either direct or indirect systems. As these switches are operated by common control equipment, they are a logical step in the evolution of fully electronic systems.

## **Halbleiter (Semiconductors)**

The second edition of Halbleiter (Semiconductors) by Rudolf Weinheimer, edited by H. Sarkowski, has been published in German with an inserted sheet giving instructions for its use in English and French.

The technical ratings and significant operating characteristics of semiconductor devices are arranged so that comparable units of German manufacture can be found quickly. The devices are classified by application, semiconductor materials, and doping. Within these groups they are arranged by electrical characteristics and by manufacturing technologies such as alloyed, diffusion alloyed, mesa, and planar. A list of

improved types and substitutes for older units is included.

An appendix on the international state of the art has been added. Input and output resistance and capacitance, forward transconductance, and current gain are plotted as functions of frequency for transistors manufactured using different technologies.

The book is 15 by 20.5 centimeters (6 by 8 inches) and contains 194 pages. It is available from Standard Elektrik Lorenz AG, Technical Publications, 42 Hellmuth-Hirth-Strasse, Stuttgart-Zuffenhausen, Germany, at DM 5 per copy.

## Recent Achievements

**Pentaconta Exchanges Cut Over in Paris**—Mr. Jacques Marette, Minister of Post and Telecommunication, officially inaugurated in January 1964 the simultaneous cutover of the Gounod and Chenier Pentaconta crossbar telephone exchanges into the Paris telephone network. He was accompanied by Mr. Jambenoire, Director General of the Paris Area, and Mr. Croze, Director General of Telecommunication.

Mr. Jambenoire stated that the successful incorporation of Pentaconta into one of the most-complex telephone switching systems in the world was a great compliment to the engineering skill of the late Mr. J. Gohorel in particular and to the numerous engineers in the Post and Telecommunication Department and in industry who cooperated in the work.

Mr. Croze pointed out that France was nearly first in placing a Pentaconta exchange in operation in a national capital. Madrid had cut over its first Pentaconta office only 26 days

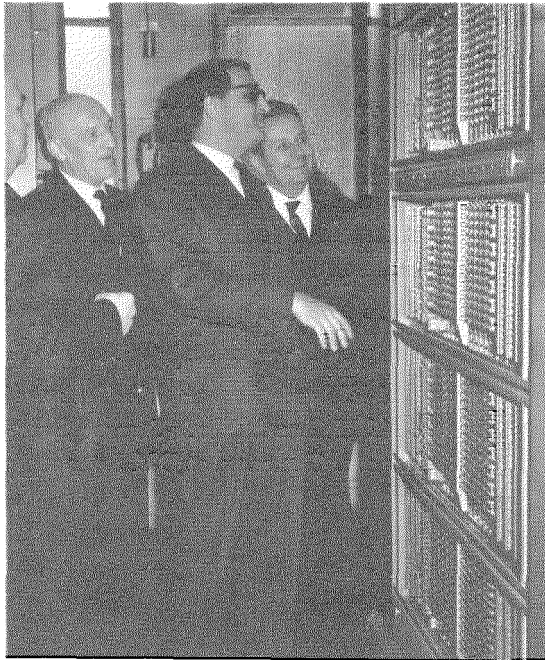

Figure 1—From left to right are Messrs. Jambenoire, Quéfféléant, Marette, and Croze inspecting crossbar switches at the new Pentaconta central office of Gounod in Paris.

before. Although some countries had adopted crossbar many years ago, they had not yet introduced such exchanges into their capital cities, such being the case for Stockholm.

Mr. Marette thanked those responsible for this achievement and expressed his conviction that increasing recognition by the public of the value of telephone service would prompt the government to expand telephone facilities throughout the country.

Although Pentaconta has been in service in many of the largest provincial towns of France, its adaptation to the rotary switching system of Paris had to be carefully engineered. Pentaconta will be installed in all new central offices and is to replace all existing Paris exchanges, many of which are more than 30 years old.

The Gounod central office is at Boulogne-Billancourt in the western outskirts of Paris and is the responsibility of Le Matériel Téléphonique. Chenier, in the northern suburb of Saint-Denis, is the work of Compagnie Générale de Constructions Téléphoniques.

Each office will have an ultimate capacity of 30 000 lines, the Gounod cutover being of 4000 lines and the Chenier of 3000 lines. A new feature is the intention of connecting them to distant concentrators that will serve up to 1000 lines. The placement of these concentrators will be dictated by the density of subscribers and the availability of connecting cables. The common equipment for supervision and control and the junctions connecting the distant concentrators with the rest of the exchange are housed in the central office.

Gounod and Chenier are directly interconnected and will use multifrequency signaling to each other. This fast signaling method will be used among all Pentaconta exchanges in France. The two new offices are connected directly to a few existing exchanges and through transit centers to the entire Paris network.

About 400 guests attended the official ceremony. Among the hosts were Mr. E. Maurice

Deloraine and Mr. Philippe Lizon, Chairman of the Board and Managing Director, respectively, of *Le Matériel Téléphonique*, and Mr. Paul Quéfféléant and Mr. Georges Goudet, Chairman of the Board and Managing Director, respectively, of *Compagnie Générale de Constructions Téléphoniques*. Figure 1 shows some of the inspection party at Gounod.

*Le Matériel Téléphonique*

*Compagnie Générale de Constructions Téléphoniques*  
France

**Transpacific Cable Inaugurated**—Known as *Compac*, the new transpacific repeatered submarine cable between Canada and Australia via Hawaii, Fiji, and New Zealand, was placed in service on 2 December 1963. It is extended to London by the trans-Canada microwave radio system and *Cantat*, the submarine cable linking Great Britain and Canada. *Compac* provides about half of the 16 000-nautical-mile (30 000-kilometer) path between London and Sydney.

A maximum of 80 voice channels are available on *Compac* and many will be used for voice-frequency telegraphy and data transmission. Wider bands can be provided for broadcast programs and for facsimile.

Semiautomatic dialing will be used between London and Sydney. Australian operators at Adelaide, Brisbane, Melbourne, Perth, and Sydney can establish calls automatically to subscribers in Great Britain. London operators will be able to call the majority of Australian subscribers directly. Similar facilities will be provided later for service to and from Canada and New Zealand.

A design objective for noise of 1 picowatt per kilometer averaged over all channels in each direction was achieved on all sections. The attenuation as a function of frequency for a single channel group over any one section of cable is within 1 decibel of the average attenuation for all groups in that section. Over more than one section, the variation is within 2 decibels.

Standard Telephones and Cables manufactured 244 of the 318 submerged repeaters, all 34 undersea equalizers, and 2800 nautical miles (5200 kilometers) of the General Post Office type of lightweight deep-sea cable as well as a large proportion of the shore-based terminal equipment and test apparatus. *Cable Restorer* of the Commercial Cable Company was one of four ships that laid the cable.

The Australia-New Zealand section was completed in June 1962, New Zealand to Fiji in December 1962, and the Fiji-Hawaii and Hawaii-Canada sections in October 1963. Figure 2 shows the arrangement on shipboard for testing the splice between each repeater and the cable.

*Standard Telephones and Cables*  
United Kingdom

**Transatlantic Cable Placed in Service**—The first telephone cable directly linking Great Britain and the United States of America, known as *TAT-3*, was placed in commercial service in October 1963. It doubles the number of transatlantic telephone cable channels previously in service.

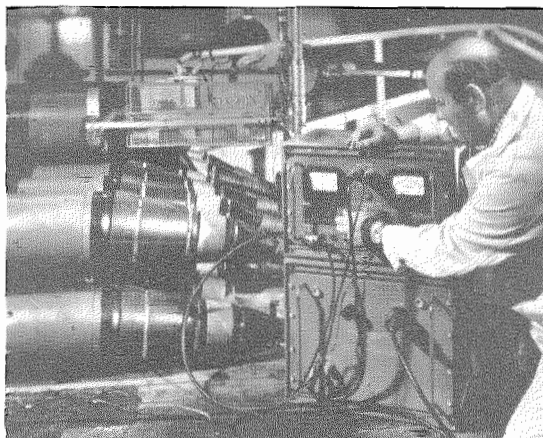

Figure 2—After each section of the coaxial submarine cable for *Compac* passes over a gantry from the factory into the hold of the cable ship *Monarch*, its repeater is spliced in and a high-voltage test of the quality of this splice is made.



## Recent Achievements

The entire 3600 nautical miles (6700 kilometers) of coaxial submarine cable were manufactured in the new cable plant<sup>1</sup> at Southampton to an order from the British Post Office. Figure 3 shows one step in the manufacture of the cable. Repeaters were inserted at intervals of 20 nautical miles (37 kilometers).

*Standard Telephones and Cables  
United Kingdom*

**Digital Transmission of Radar Pictures**—A digital narrow-band transmission of radar pictures was demonstrated to personnel of the Swedish defense and civil aviation authorities. The quality of the transmitted pictures, one of which is shown in Figure 4, was considered to be ex-

<sup>1</sup> E. Baguley, "Submarine-Coaxial-Cable Manufacture at Southampton Factory 2," *Electrical Communication*, volume 38, number 4, pages 475-486; 1963.

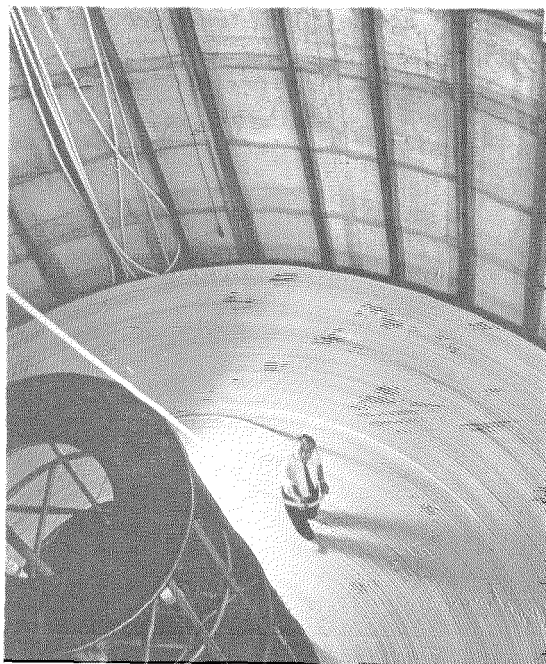

Figure 3—Miles of finished coaxial cable are coiled down into a tank, which is then filled with water that is held at a constant temperature, for final electrical tests.

cellent despite the use of transmission equipment built for other services and not best suited for this application.

Called Natrap, the system features the transmission of preferred useful information, such as targets, with the original radar accuracy being maintained. This permits automatic data processing at the receiving end.

*Standard Radio & Telefon  
Sweden*

**Model 75 Teleprinter for Telex**—Cable and Wireless Limited has chosen the model 75 Teleprinter as its standard for telex service. About 100 of an initial quantity of 440 will be installed in a manual telex network in South America and the remainder, together with associated equipment provided by Standard Telephones and Cables, will be the start of a fully automatic telex system in the Far East.

For telex service, these smallest and lightest teleprinters are equipped with tape readers,

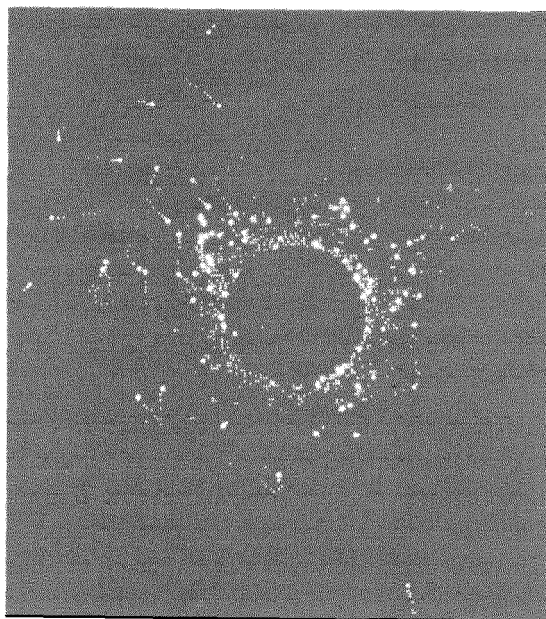

Figure 4—Typical radar picture transmitted over the narrow-band digital system called Natrap.

reperforators, and new silencing covers as shown in Figure 5.

*Creed & Company  
United Kingdom*

### Flight Training Simulator for Étendard Aircraft

—For training purposes a simulator of the flight performance of the Étendard *IV-M* carrier-borne aircraft has been developed and two units delivered to the French Aéronavale.

Based on the same techniques used in the simulator for the Mirage aircraft,<sup>1</sup> the new equipment has added a closed-loop television system, the camera of which views a model of an aircraft carrier complete with its deck-mounted landing-mirror system. In addition to the usual 3 degrees of freedom, the camera will also imitate the roll, pitch, and yaw of an aircraft. The received television picture is projected on a large screen in front of the simulator cockpit. The image subtends an angle of 60 degrees to the pilot's eye and covers a zone up to 2 kilometers (1.3 miles) from the carrier, from sea level up to 250 meters (820 feet).

Simulation includes all aerodynamic characteristics of the Étendard aircraft, the performance of its jet engine, fuel consumption, hydraulic and electric systems, radar, tacan, height indication, very- and ultra-high-frequency communication links, and their use for ground- and carrier-controlled approach. It is used for all stages of training from engine starting, take-off, flight, interception, approach, and landing. The entire simulator is mounted in a semitrailer that is approximately 10.7 by 3.7 by 2.4 meters (35 by 12 by 8 feet) and weighs 13.6 megagrams (15 tons).

*Le Matériel Téléphonique  
France*

**Tacan Ground Beacons**—Two tacan ground beacons that will furnish up to 100 aircraft within line-of-sight 200-mile radius with distance and bearing information have been developed.

The *AN/TRN-14*, shown in Figure 6, is supplied to the United States Marine Corps. It is completely self-contained and can be transported by helicopter, truck, or even towed over the ground. Weighing just over 2000 pounds (900 kilograms), it is lighter and smaller than other designs. It can be set up in operating condition by two men in 15 minutes.

The installation consists of a cabinet housing the transmitter, receiver, and controls; another cabinet for the power supply and antenna control; a protected rotating antenna mounted on a telescoping mast; and a transport pallet. Capable of operating from  $-65$  to  $+150$  degrees fahrenheit ( $-54$  to  $+66$  degrees centigrade), the unit is protected against shock. Plug-in

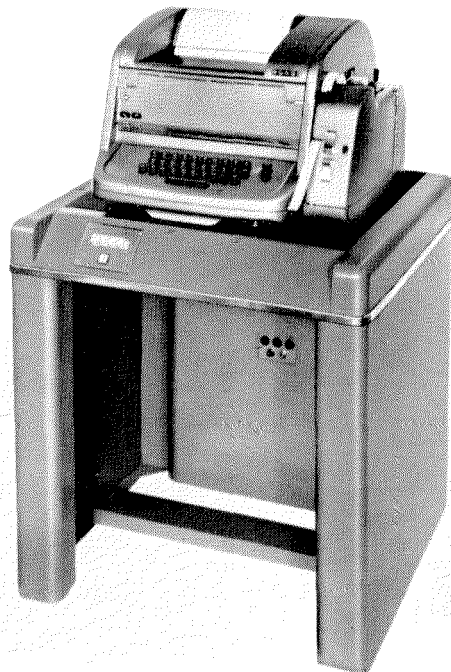

Figure 5—Manual telex version of the model-75 teleprinter.

<sup>1</sup>S. M. Poole, "Flight Simulator for Mirage III," *Electrical Communication*, volume 37, number 3, pages 196-201; 1962.

## Recent Achievements

modules simplify servicing. Both semiconductors and vacuum tubes are used.

The *AN/TRN-17* is furnished to the United States Air Force as an emergency-mission support that can be assembled in about two hours. It is shipped in a single box-like shelter that includes a 35-foot (10.7-meter) mast for the antenna. Built-in test equipment and modular design are aids to maintenance.

*ITT Federal Laboratories  
United States of America*

**Precision Approach Radar**—The *SLA-3C* precision approach radar for monitoring the high-speed low-angle approaches of small jet aircraft is an improvement over the previous *SLA-3B* design. It produces more-consistent and more-reliable echoes from small fighter aircraft, especially in the 12-to-14-mile (19-to-23-

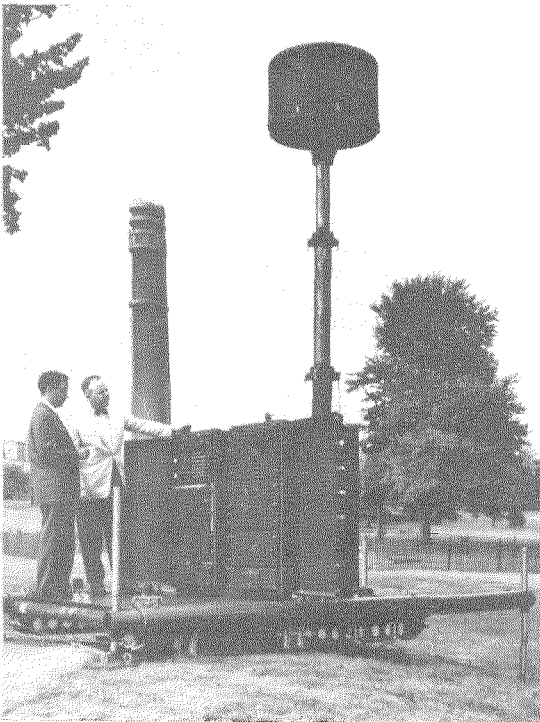

Figure 6—Transportable tacan ground beacon, *AN/TRN-14*. The microwave tower of ITT Federal Laboratories is in the background.

kilometer) range. It gives a much-clearer and less-cluttered display because the system discriminates against permanent echoes and the receiver has an improved noise performance.

Two 17-inch cathode-ray tubes provide for elevation and azimuth displays as shown in Figure 7. Additional display consoles can be added. The structure in which the radar transmitting and receiving elements are mounted may be rotated to serve various runways and is operated remotely from the airfield control tower.

*Standard Telephones and Cables  
United Kingdom*

**Railroad Central Control**—An interlocking supervisory system was installed on a 5000-kilometer (3100-mile) electrified railroad line of the Deutsche Bundesbahn. Push-button control with diagram indication of the system operating conditions is centralized at the Haltern station of the line. From this point 121 main and 176 shunt routes are controlled. There are 76 switchpoints and derailleurs, 19 main and 57 shunt signals, and 71 track circuits. Of the *SpDrL 30* type, this new system replaces a master and 5 subordinate signal towers. The installation and final testing of the entire system



Figure 7—Display console of the *SLA-3C* precision approach radar.

was completed in the extraordinarily short time of 5 months, being turned over just one week before being placed in service.

A similar system replacing 3 signal towers was put in service some weeks earlier on the Stuttgart-Ulm line with control at the Geislingen Steige station.

*Standard Elektrik Lorenz  
Germany*

**Traveling-Wave Tubes**—The *F-2500* line of traveling-wave tubes includes two series, each illustrated in Figures 8 and 9.

A range of 12 voltage-tuned backward-wave oscillators covers from 1 to 12 gigahertz with power outputs from 25 to 250 milliwatts at operating voltages of 250 to 1000 volts and cathode currents not exceeding 25 milliamperes. Both unifilar and bifilar helices are used with permanent-magnet focusing. No cooling is needed for ambient temperatures below 60 degrees centigrade. These tubes are suitable for signal generators, master oscillators, and local oscillators in radar receivers.

The second series consists of four tubes capable of generating peak pulse powers of 1000 watts. Two of the four tubes are cathode pulsed and two have grids, one of each covering from 2 to 4 gigahertz and the other two from 4 to 8 gigahertz. They are of metal-ceramic construction

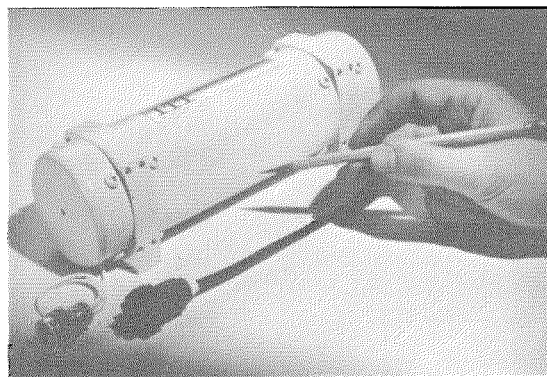

Figure 8—Traveling-wave tube and permanent-magnet focusing assembly for oscillation in the region from 1 to 12 gigahertz.

and use periodic permanent magnets for focusing.

*ITT Electron Tube Division  
United States of America*

**Measurement of Properties of Thin Magnetic Films**—

The equipment shown in Figure 10 permits instantaneous measurement of the properties of thin magnetic films. It produces a star-shaped pattern on the oscilloscope which, with knowledge of the direction of the applied magnetic field, permits study of the field strength to switch the film, the direction of easy magnetization, the coercive forces, and the anisotropic fields.

Called an astrometer by its inventors, the device allows testing immediately after manufacture of thin films intended for ultrafast storage units. A probe rod used for determining the signal-to-noise factor operates over a band 1000 times wider than do magneto-optical probes, which increases the precision of the measurements.

*Laboratoire Central de Télécommunications  
France*

**Digital Data Devices for Command and Control Systems**—

A transmitter, a receiver, and a character generator developed for command and control systems employ solid-state components and modular construction. Visual operation and fault indicators are provided as well as fault-isolation circuits.

The *KD-5040* transmitter scans input storage units for traffic. On finding a complete message,

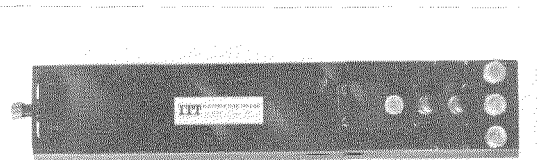

Figure 9—Pulsed traveling-wave amplifier with periodic permanent magnets for 1000-watt-peak operation between 2 and 8 gigahertz.

## Recent Achievements

it connects itself to that unit, selects a suitable transmission channel, and in transmission inserts any required control data in the header or other appropriate places in the message. It provides for parallel-to-serial code conversion, vertical parity check, and horizontal parity generation.

The *KD-5050* receiver converts high-speed serial data into 8-bit parallel code, recognizes specific message headers, generates functions for controlling other equipment, and checks both horizontal and vertical parity. It forwards the input data to the designated output

or to storage at rates up to 10 000 bits per second.

The *KD-5060* character generator translates digital data into alphanumeric or symbolic characters at speeds up to 320 000 bits per second for presentation on a cathode-ray tube. The output consists of signals for generating the raster, for the *X* and *Y* positioning of the cathode-ray beam, and for turning the beam on to illuminate the character to be presented. Its input in either serial or parallel 6-bit or 8-bit binary code may be obtained from stores, registers, or keyboards.

*ITT Kellogg Communications Systems  
United States of America*

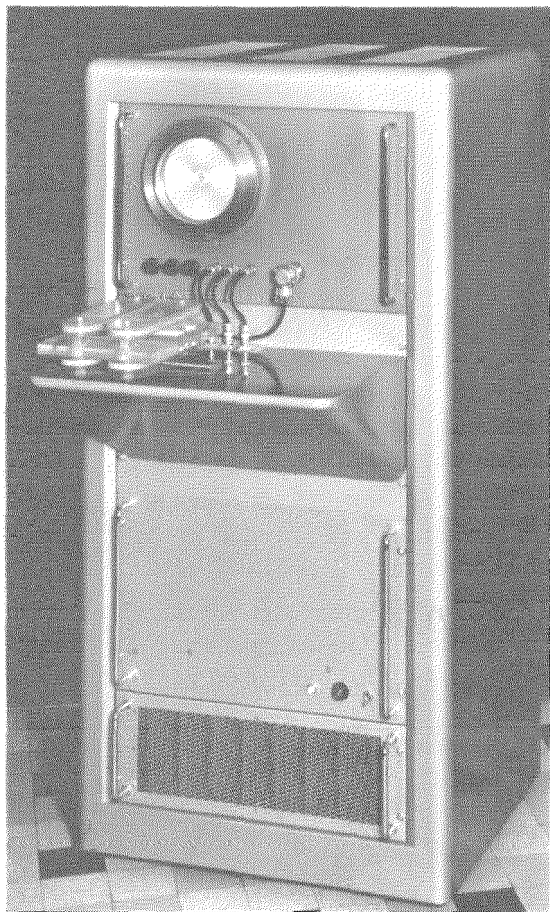

Figure 10—Measuring equipment for determining the properties of thin magnetic films. It is called an astrometer.

**Pentaconta Telephone Exchange Cut Over in Spain**—About 40 years ago, Compañía Telefónica Nacional de España was set up to provide telephone service for Spain. The rotary automatic switching system was then adopted exclusively. It has now been decided to use the Pentaconta system for future expansion. The first large Pentaconta exchange in Spain was recently cut over in Madrid.

This new Albufera central office will have a final capacity of 20 000 lines. Of the 6000 lines installed, 3800 are regular subscribers, 1200 are 2-party lines, 600 are coin boxes, and 400 are private automatic branch exchanges. It has 600 incoming and 800 outgoing junctions, the latter including those to special services.

It operates fully with various types of rotary switching. For the inner-area Madrid traffic, it is connected in 23 directions to present 7A1 and 7A2 exchanges. For the outer area, it works with 3 tandem offices using 7D equipment. For traffic beyond the city but in Madrid province, there are connections with a 7D transit exchange. Automatic toll traffic is handled with an 8A transit toll exchange.

This first Pentaconta cutover will be followed soon by 2 more in Madrid, 3 large exchanges in Barcelona, and 13 others now under construction in urban centers.

To support this program of expansion, a new factory has been built at Villaverde, in the outskirts of Madrid. Its 16 000 square meters (171 160 square feet) and 1700 workers are devoted exclusively to the manufacture of Pentaconta equipment.

*Standard Eléctrica  
Spain*

**Switching Installations at Maison de la Radio, Paris**—In December 1963, President de Gaulle inaugurated the new Maison de la Radio in Paris of the French national radio and television services. Its extensive radio-program and telephone switching systems feature Pentaconta equipment.

A 4000-line automatic telephone switching system provides for the 2500 subscriber sets in the building. It permits direct internal dialing, whereby any station in the building can be dialed directly from the public network by a 7-digit number without the services of an operator. An independent switching system for 200 lines interconnects executive and technical staffs.

The broadcast programs are handled by a separate semiautomatic exchange having 168 incoming and 188 outgoing lines controlled from a 5-operator desk and from 17 monitoring booths. Up to 50 combinations of program sources and users may be set up to be switched simultaneously by operation of a push button. This program system must be flat to within 0.5 decibel between 40 and 15 000 hertz, and crosstalk and noise must be at least 90 decibels below reference signal level.

In addition to these 3 systems, a 300-line cordless manual exchange provides for telephone connections between the technical staff and distant sources and users of programs. An automatic exchange having 110 outlets permits loudspeaker communication on a 4-wire basis among studios, control booths, and the central control desk. Another exchange permits any of 104 sources of programs to be dialed by any

number of 176 different points equipped with high-fidelity loudspeakers for monitoring purposes.

The amount of apparatus required by this installation corresponds to that for an automatic central office to serve a town of 50 000 persons.

*Compagnie Générale de Constructions Téléphoniques  
France*

**Barcelona-Valencia Coaxial System**—A new 4-megahertz coaxial system has been installed between Barcelona and Valencia in Spain for Compañía Telefónica Nacional de España. The 216-mile (347-kilometer) system includes 3 main and 34 intermediate repeaters in addition to the 2 terminal repeaters.

The equipment was manufactured in Madrid by Standard Eléctrica to the designs of Standard Telephones and Cables so as to conform with previous installations of carrier equipment made by the London company.

*Standard Eléctrica  
Spain*

**Loudspeaker Command System for Power Station**—A new communication technique for operating power-generating stations has been introduced in the Rugeley plant, just north of Birmingham. About 200 loudspeakers suitably placed in the operating area broadcast instructions to operating personnel from the control room. Reply may be made through microphones that also connect to the loudspeaker system so that other floor personnel may hear both instruction and response. The loudspeakers are also used for paging operating personnel.

A high noise level is overcome by using 12 amplifiers, the output of each being 150 watts. Noise-cancelling microphones are used and in noisier areas head-type sound-absorbing booths are provided. Failure alarms and standby amplifiers assure uninterrupted service.

*Standard Telephones and Cables  
United Kingdom*

## Recent Achievements

**New Laser Lines in Helium-Neon**—To search for new frequencies at which emission may be stimulated, a very-high-gain gas laser has been built. It uses a fused-silica tube 8 meters (26 feet) long with an inside diameter of 9 millimeters (0.35 inch). It is closed by 2 silica windows set at the Brewster angle. The tube is connected to a high-vacuum pump and may be filled with various gases of high purity. The interferometer uses 2 silvered mirrors in a nearly confocal configuration. Both prism and grating spectrographs are provided, the latter for precise measurement of wavelength.

An examination of helium-neon mixtures has disclosed 4 new lines of emission having wavelengths in air of 12 912, 19 573, 21 041, and 21 708 angstrom units. These are shown in Figure 11, with the well-known laser lines at 11 523 and 33 933 angstrom units.

It is of interest that in certain ranges of pressure and gas mixtures, several transitions may occur simultaneously. Thus in a wide-band laser employing silvered mirrors that are nonselective, true optical pumping results in that one

stimulated emission causes additional transitions.

*Laboratoire Central de Télécommunications  
France*

**Error-Control Techniques Demonstrated**—Four different techniques for error control in data transmission developed within ITT Europe were demonstrated in September 1963 to delegates attending a meeting of the Comité Consultatif International Télégraphique et Téléphonique Study Group Special A (Data Transmission) in Geneva.

Two of the demonstrations were of data transmission over telegraph channels. The *Thedar-M* system of Standard Elektrik Lorenz uses the block-retransmission principle and operates over half-duplex connections. The *STC-50* system of Standard Telephones and Cables is based on information feedback and is suitable for full-duplex connections.

The other two demonstrations were of medium-speed data transmission over telephone channels. The *STC 600/1200* system of Standard Telephones and Cables uses the block-retransmission principle and the *ITT GH-201* of Standard Radio & Telefon (Sweden) uses a character-by-character method.

Through the courtesy of the Swiss government, the demonstrations were over local and long-distance connections of the Swiss national network.

*Standard Telecommunication Laboratories  
United Kingdom*

**Ground Receivers to Pinpoint Satellites**—Eight solid-state dual receivers have been delivered to the United States Navy to help determine the exact positions of orbiting space vehicles through precise measurement of the frequencies received from them. The orbits of the satellites must be known precisely because this affects the accuracy of ground navigational bearings taken from them.

Figure 11—Energy levels and stimulated transitions in helium-neon lasers. Wavelengths are in angstrom units.

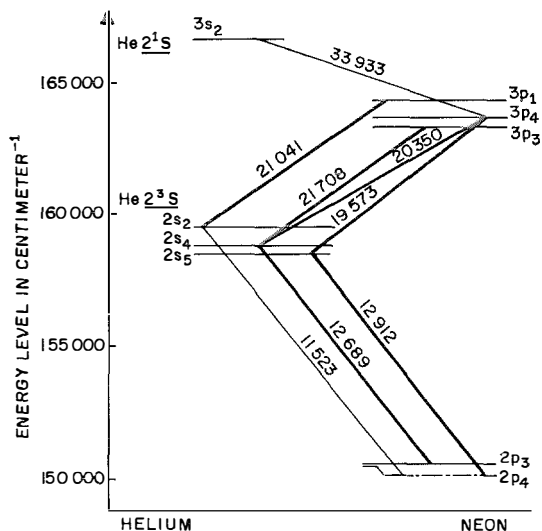

Each receiver incorporates circuits for automatic search and acquisition. The tracking channel uses a selectable bandwidth.

*ITT Federal Laboratories  
United States of America*

**New Zealand Pentaconta Exchange Cut Over—**

The first Pentaconta crossbar telephone exchange in New Zealand was cut over in December 1963 at Oamaru, on the South Island. This 2000-line central office will work with the existing 7A2 rotary installation in Oamaru.

*Compagnie Générale de Constructions Téléphoniques  
France*

**Repeaters for 960-Channel Coaxial Systems—**

Two repeaters have been developed to be spaced either 2.9 or 4 kilometers (1.8 or 2.5 miles) apart in transmission lines using small-diameter coaxial cable. The operating direct-current power is sent over the cable.

The recommendation of the Comité Consultatif International Télégraphique et Téléphonique that at least 900 channels may be carried by halving the repeater spacing for 300-channel

systems is responsible for the shorter-distance repeater.

From Figure 12 and Table 1, it will be evident that the 4-kilometer unit has higher gain and employs two separate amplifiers coupled by a shunt adjustable equalizer. The 2.9-kilometer repeater has a single amplifier and the gain-control network is in a feedback circuit.

The gain-versus-frequency characteristic of both repeaters may be adjusted either manually or automatically to accommodate cable tolerances and temperature variations by adjusting the value of the equalizer termination. Voltage-limiting devices protect against lightning and other induced charges.

*Standard Telecommunication Laboratories  
United Kingdom*

**Pilot Level-Measuring Equipment—**

A test set has been developed for checking pilot signals in multichannel telephone systems. With  $\delta$  being set equal to either 80 or 140 hertz, the following frequencies in kilohertz may be received:  $36 \pm \delta$ ,  $84 + \delta$ ,  $132 + \delta$ ,  $180 + \delta$ ,  $228 + \delta$ ,  $336 - \delta$ ,  $384 - \delta$ ,  $432 - \delta$ ,  $480 - \delta$ ,  $528 \pm \delta$ ,  $152 + \delta$ ,  $412 - \delta$ , 60, 256, and 556.

Separate inputs are provided for 75 and 150 ohms. The bandwidth at 40 decibels down is 120 hertz. Signals from +4 to -110 decibels referred to 1 milliwatt can be measured to an accuracy within 4 percent.

Highly precise frequencies of 12 kilohertz and 124 kilohertz and a power supply of -24 volts for operation of the test set are available from a separate unit. The test set, shown in Figure 13, measures 490 by 224 by 200 millimeters (19.3 by 8.8 by 7.9 inches).

*Standard Téléphone et Radio  
Switzerland*

**Paris International Incoming and Transit Center—**

The first part of the international incoming and transit center was put in operation in July 1963 at Pastourelle, near Paris.

TABLE 1  
REPEATER CHARACTERISTICS

	2.9-Kilometer (1.8-Mile) Spacing	4-Kilometer (2.5-Mile) Spacing
Gain in decibels at 4 megahertz	30.6	42.2
Maximum power output in decibels referred to 1 milliwatt	13	19
Noise figure in decibels	6	6
Pre-emphasis in decibels	6	10
Gain control in decibels at 4 megahertz	$\pm 3$	$\pm 3$
Power consumption of 2-way repeater:		
Volts	30	36
Milliamperes	40	50
Maximum distance in kilometers (miles) between power insertion points using $\pm 250$ volts to earth	76 (47)	88 (55)



## Recent Achievements

This automatic toll center receives calls from provincial toll centers and foreign exchanges, including calls from the United States via sub-

marine cable. These calls are directed to Paris subscribers over 2-wire lines and to toll centers and foreign exchanges over 4-wire connections.

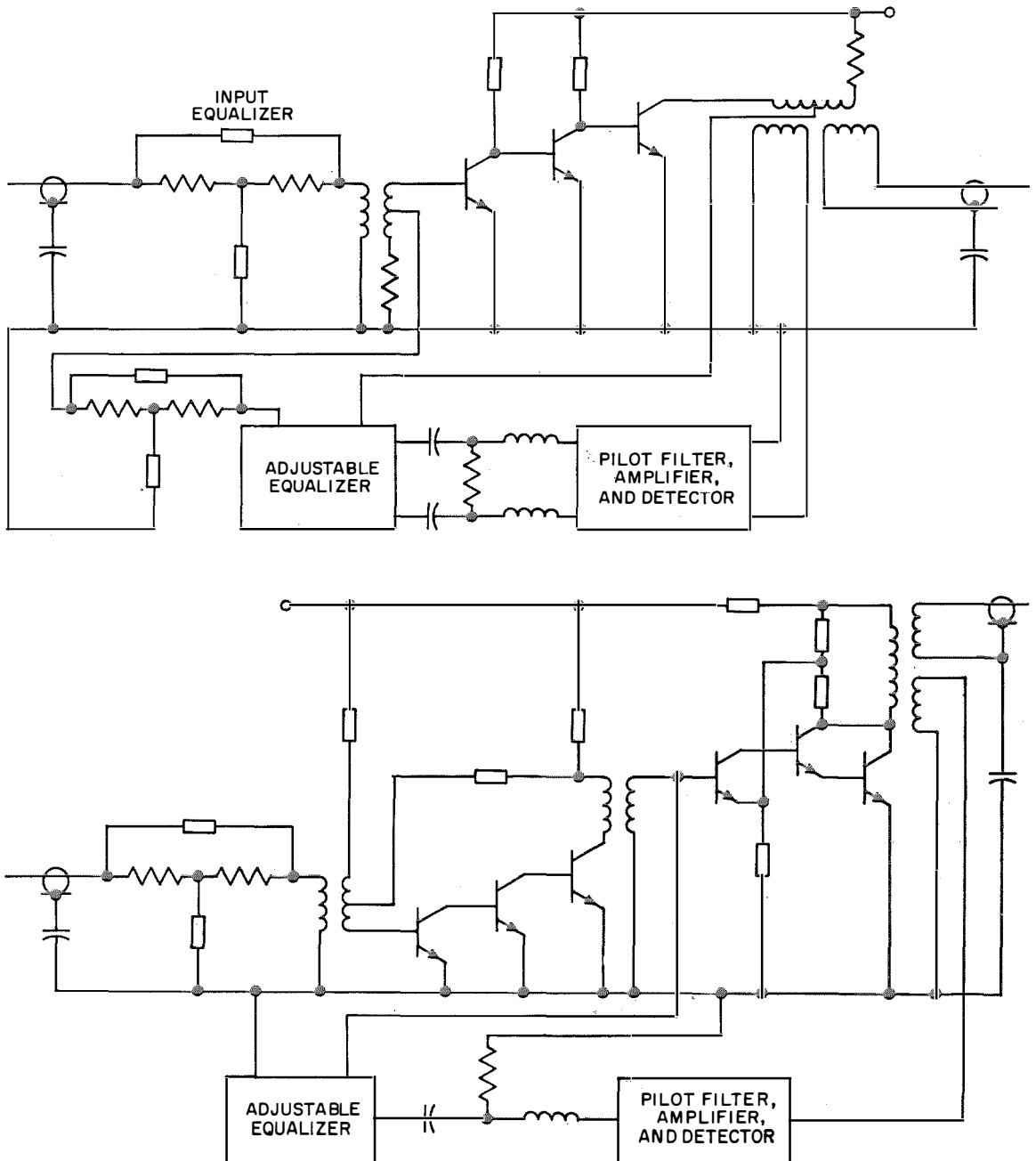

Figure 12—Circuit arrangements for two repeaters for coaxial cable systems. The top unit is for 2.9-kilometer (1.8-mile) spacing and the bottom is for 4-kilometer (2.5-mile) spacing. The unidentified rectangles are impedance networks.

It serves also to provide for overflow traffic between important provincial centers when the number of direct circuits between them is inadequate.

Employing Pentaconta crossbar equipment, the center was initially provided with 604 incoming and 430 outgoing 4-wire junctors and 460 outgoing 2-wire junctors. Its maximum capacity will be 1568 incoming and 1120 outgoing 4-wire circuits and 1344 outgoing 2-wire circuits.

*Le Matériel Téléphonique  
France*

**Pulse Code Modulation Over Telephone Junction Cables**—By the use of pulse code modulation, 23 speech channels and their associated signaling can be accommodated on two normal pairs in a junction cable. On a typical 100-pair cable, about 60 pairs could be used, so that the cable capacity is increased about 7 times.

A 1728-kilobit-per-second binary pulse train is transmitted. It can be regenerated despite severe crosstalk, noise, and distortion. Speech quality is such that quantization noise should be inaudible under normal telephone use. The specifications relating to noise and bandwidth for toll service set up by the Comité Consultatif International Télégraphique et Téléphonique are satisfied for 3 systems in tandem. Normal repeater spacing is at 2000 yards (1800 meters), which is the loading-coil spacing, on cable of 10 or 20 pounds per loop mile (22 or 19 American wire gauge, 0.64 or 0.9 millimeter in diameter). A 2-way repeater occupies 6 by 2.6 by 0.6 inches (150 by 67 by 15 millimeters) and consumes 450 milliwatts. Power for 20 repeaters may be sent over the signal pairs between two power-supply points.

A prototype terminal is shown in Figure 14. The 2 larger subracks contain the measuring facilities and the transmission equipment, such as, multiplexers, companders, and coders. The top subrack houses the power supply and the 2 lower small subracks enclose the hybrid coils and

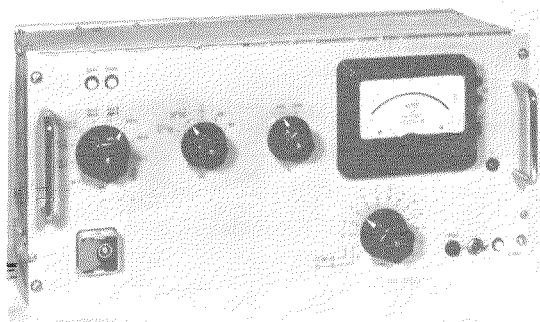

Figure 13—Level-measuring set for pilot frequencies in multichannel telephone systems.

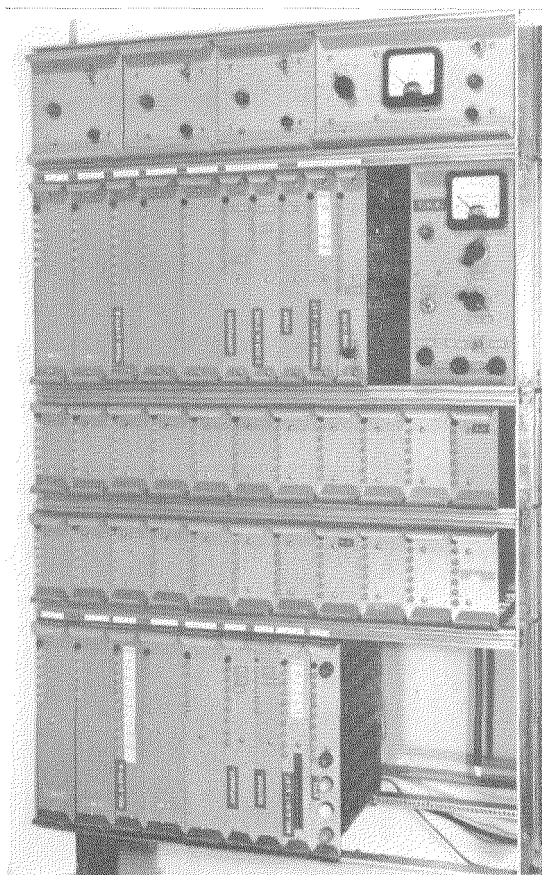

Figure 14—Prototype 23-channel pulse-code-modulation terminal for multiplex operation over existing telephone junction cable.

## Recent Achievements

signaling relays. Construction is mainly in ITT Europe standard equipment practice and Mini-stac. The terminal occupies 1 meter of vertical rack space and consumes 50 watts.

Two systems, similar to the prototype, will be installed for the British Post Office for field trial.

*Standard Telecommunication Laboratories  
United Kingdom*

**Radiotelephones for Paris Taxicabs**—An initial quantity of 300 radiotelephone mobile transmitter-receiver sets has been supplied for Paris taxicabs through arrangements with the *Chambre Syndicale des Artisans du Taxi*, an organization of 3250 members. Communication between a fixed station located at Montmartre and the mobile units will be on two channels allotted for this service by the Post and Telecommunication Department.

At the base station there are 4 sets, 2 of which are spares. Each *ERF 3476-A* set includes a 25-watt transmitter, receiver, remote control, mains power supply, and an emergency battery power supply with automatic changeover.

In each taxicab, as shown in Figure 15, is an *ERM 3468-A* set consisting of a 10-watt trans-



Figure 15—Mobile radiotelephone installation in a Paris taxicab.

mitter, receiver, and push-to-talk microphone. A whip antenna is used.

*Le Matériel Téléphonique  
France*

**Spacecraft Navigation Aid Using Starlight**—A navigation aid has been developed for artificial satellites temporarily placed in orbit about the earth before being started into outer space. During this parking orbit, a new star tracker will detect and lock on to the light from pre-selected bright stars. Should the guidance equipment of the satellite drift, the star tracker would generate command signals to correct for the errors before the satellite starts on its mission. An experimental model has been delivered to the National Aeronautics and Space Administration.

*ITT Federal Laboratories  
United States of America*

**Speech Microscope**—An equipment has been developed that can isolate individual sounds or words from a tape recording and replay them repeatedly for detailed examination.

The turntable shown in Figure 16 can be rotated so that the two reproducing heads mounted 180 degrees apart on it will travel at 3.75 or 7.5 inches (9.5 or 19 centimeters)

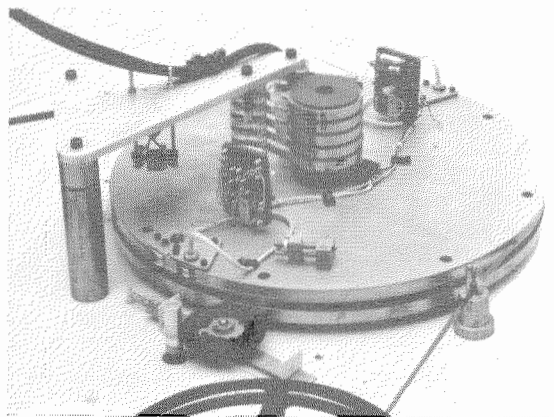

Figure 16—Tape reproducer for speech analysis.

per second. The tape to be reproduced is held stationary round the rim of the rotating disc and guides allow the length of tape in contact with the disc to be adjusted. A signal derived from the rotating disc provides a reference to trigger adjustable time-delay switches so that only a particular part of the recording will be reproduced.

Separate transistor preamplifiers are mounted at each head and their outputs are matched before passing over the rotating slip rings to the main amplifiers. Record and erase facilities are available for the lower sound track for use in analyzing the recording on the upper track.

Sounds incorrectly heard in talking-listening tests can be extracted and analyzed in detail.

*Standard Telecommunication Laboratories  
United Kingdom*

**High-Power Broad-Band Waveguide Switch—**

The *KU901* waveguide switch, for use in the 4-to-7-gigahertz region, depends on the interaction of a confined hydrogen plasma with the electromagnetic wave for its operation. It has applications in duplexers (in which it eliminates spike voltages), in pulse-width modulators and shapers, and in ring resonators.

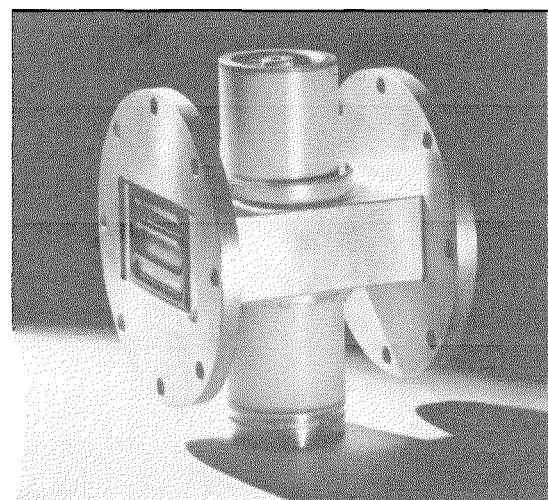

Figure 17—High-power broad-band waveguide switch.

As a single-pole single-throw switch, it will operate at a peak power of 1 megawatt with a duty factor of 0.001. In the open condition, it provides 30 decibels isolation and in the closed condition an insertion loss of 0.2 decibel. Switching time is 80 nanoseconds. The peak anode current of 50 amperes at 2000 volts will be triggered by 100 volts applied to the grid. The metal-ceramic construction permits operation at a maximum seal temperature of 250 degrees centigrade.

The 5-pound (2.3-kilogram) unit shown in Figure 17 is dimensioned for insertion in RG/49-U waveguide.

*ITT Electron Tube Division  
United States of America*

**High-Temperature Selenium Rectifiers—**

A new series of selenium rectifiers will carry 1.5 times the load current of equivalent conventional units at an ambient temperature of 35 degrees centigrade and will operate up to 120 degrees. They are free of aging effects.

Any conventional unit may be replaced by the next smaller size of the new series (see Figure 18). The new series are made in sizes ranging from 20 by 20 millimeters (0.8 by 0.8 inch) to 100 by 500 millimeters (4 by 20 inches). The

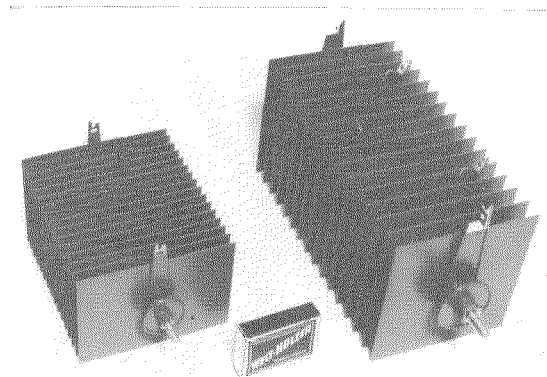

Figure 18—Both these selenium units will rectify 12 amperes at 100 volts input, the new series at the left being substantially smaller than the conventional unit at the right.

## Recent Achievements

higher working temperature permits greater heat dissipation particularly with forced air cooling.

*Standard Elektrik Lorenz  
Germany*

**Selenium Rectifiers for Printed Circuits**—A small bridge-connected selenium rectifier rated for 2.5 amperes at 20 volts input has been produced for television receivers using transistors. The 4 connecting lugs permit the unit to be mounted directly on a vertical printed-circuit board by soldering. The unit is shown in Figure 19.

This method of mounting provides for only natural air cooling, there being no large metal chassis to serve as a heat sink. The 4 rectifier plates are therefore spaced from each other. By operating the plates at a high current density and a low loss of about 0.46 watt per square inch (0.07 watt per square centimeter), the weight and volume are small enough to permit this type of mounting.

*Standard Elektrik Lorenz  
Germany*

**Production Line for Solid Tantalum Capacitors**—A new semiautomatic production line for solid tantalum capacitors was inaugurated at

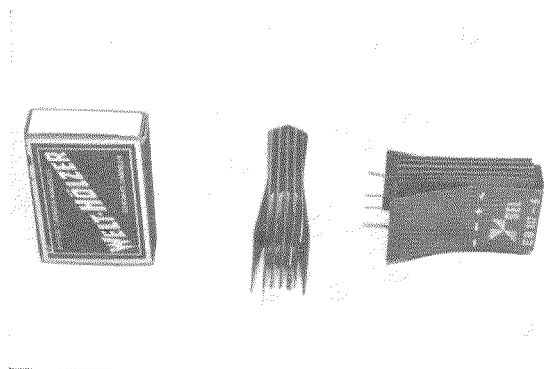

Figure 19—Bridge-connected selenium rectifiers for mounting on printed-circuit boards. The rectifiers are intended for power supplies of television receivers using transistors.

Paignton by Dr. W. H. Penley, Director General of Electronics Research of the Ministry of Aviation.

Manufacture is in a specially clean area, access to which is via air locks. Operators wear white dust-free and lint-free overalls. Purity of materials and exceptionally high standards of cleanliness are assured by continuous quality-control inspection.

Tantalum foil and a liquid electrolyte form an extremely stable tin-oxide layer that is a good dielectric for a capacitor. The solid type uses a dry semiconductor in place of the liquid. In addition to the advantage of being dry, the capacitors are small, have excellent electrical characteristics, and operate over a wide temperature range. They are used in aircraft, missiles, computers, and in other critical applications requiring high reliability.

*Standard Telephones and Cables  
United Kingdom*

**Metalized Polycarbonate Capacitors**—Polycarbonate, a plastic material developed in Germany by Farbenfabriken Bayer AG, has especially good electrical properties for capacitor use. It is available as foil with a minimum thickness of 6 micrometers (0.00024 inch).

For wound capacitors, aluminum evaporated on the polycarbonate foil provides electrodes that

TABLE 2  
ELECTRICAL PROPERTIES OF  
POLYCARBONATE CAPACITORS

Temperature in Degrees Centigrade	Relative Capacitance Change in Percent from +20-Degree Value	Insulation in Ohm-Farads	Tangent $\delta$ at 800 Hertz ( $\times 10^{-3}$ )
-40	-0.9	60 000	2.5
-20	-0.5	60 000	1.8
0	-0.2	60 000	1.2
+20	—	60 000	1.0
+60	+0.3	40 000	1.0
+85	+0.6	15 000	1.1
+100	+0.9	5 000	1.2
+125	+1.3	500	1.4

are self-healing if breakdown occurs. The units have a high capacitance-to-volume ratio. Short connecting paths reduce lead inductance. Typical electrical properties are given in Table 2.

In general, the properties of these capacitors change little with temperature and by appropriate derating they can be operated at 125 degrees centigrade. They are being produced in capacitances between 0.1 and 10 microfarads and for direct working voltages of 160 and 400.

*Standard Elektrik Lorenz  
Germany*

**Intercommunication Telephone Sets**—Three new intercommunication telephone sets provide for the following systems: 11 stations connected to 2 internal and 2 public-network lines, 7 stations connected to 1 internal and 2 public-network lines, and 5 stations connected to 1 internal and 1 public-network line. The direct-current supply is at 12 volts and the signaling lamps operate from alternating current at 10 volts. Printed circuits and highly reliable components minimize maintenance. A set is shown in Figure 20.

*Fabbrica Apparecchiature per Comunicazioni  
Elettriche Standard  
Italy*

**Pneumatic Tube System with Carrier-Return Facility**—To minimize the number of empty carriers at each station in a pneumatic tube system, a return system has been developed. Each switching station in the system is provided with a separate storage tube and a control mechanism to call back empty carriers from every station on its line.

The largest pneumatic tube system in Germany at the clinic of the Free University of Berlin will be equipped for this type of carrier return. The total tube length will be 7.5 kilometers (4.7 miles). The initial 121 stations will be dis-

Figure 20—New intercommunication subscriber sets.

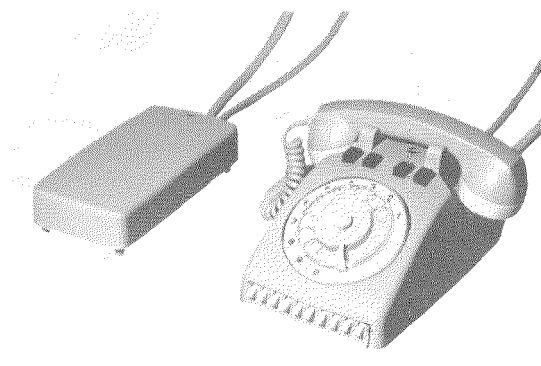

tributed among 10 lines served by 2 switching stations. The tube diameter will be 100 millimeters (4 inches.)

*Standard Elektrik Lorenz  
Germany*

**Microwave System Between London and Bristol**

—The new 600-foot (183-meter) tower of the General Post Office that now dominates the London skyline and many more of lesser heights will serve a 960-channel microwave system to Bristol. Operation will be on the 4-gigahertz band. There will be one working and one standby system with automatic changeover in case of a fault. The system can be used for 625-line television as well as telephony.

*Standard Telephones and Cables  
United Kingdom*

**Crossbar Telephone Switching for Fünen**

—The Fünen Municipal Telephone Company has contracted for the replacement of its present manual telephone installation by an automatic crossbar switching system. About 37 000 lines are involved in this system serving 300 000 persons in an area of 1150 square miles (2980 square kilometers).

*Standard Electric Aktieselskab  
Denmark*

# Ministac—A Versatile Method for Constructing Component Assemblies

H. T. PRIOR

ITT Europe; Brussels, Belgium

## 1. Introduction

The general trend in electronics makes it necessary to provide means of constructing modular assemblies smaller and more-tightly packed than plug-in cards. In considering this problem, it was necessary to choose between two possible approaches. The first possibility—the

one adopted for Ministac—was to provide a means of packaging conventional components compactly. The second possibility was to provide a range of components specially designed to have good packaging properties. The micro-module is an example of this approach.

The first method avoided the very-heavy investment and time delay involved in developing special components. Also, it was clear by 1961 that the better packaging of the micromodule would soon be superseded by the newer thin-film and semiconductor circuit techniques.

The choice having been made, the main objectives of the development were as follows.

- (A) Operation up to a few hundred megahertz.
- (B) Assemblies should be repairable.
- (C) Economical manufacture of both small and large quantities of a particular design.
- (D) Hand-made prototypes should be in manufacturable form. This would avoid changes in performance and simplify the translation of laboratory information into production information.
- (E) Engineering methods should be as simple as possible.

## 2. Construction

Figure 1 shows a typical Ministac assembly. It consists of a pair of parallel surfaces to which

Figure 1—Ministac trigger circuit.

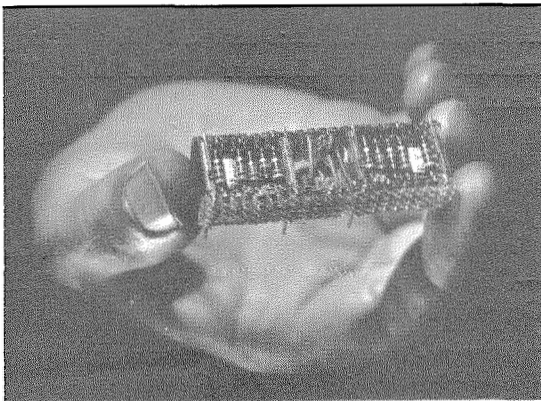

Figure 2—Metal strip punched with standard pattern.

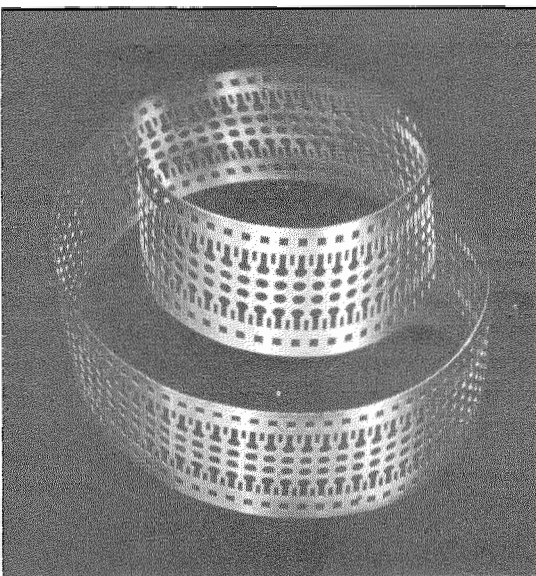
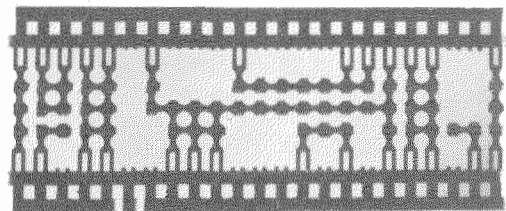

Figure 3—Metal strip punched for a particular circuit.



the circuit components are attached. The key feature is that a combination of "wiring" and soldering tags is provided by punching out a required pattern from a metal strip.

Figure 2 shows the perforated metal tape from which the "wiring" with integral soldering tags is made. It consists of a mass-produced nickel-silver strip with a special pattern of punched apertures. The circular holes are spaced 2.54 millimeters (0.1 inch) in both coordinates.

The unwanted parts of the basic pattern are removed to produce the interconnection pattern required for a particular circuit. This is done in two stages.

The metal necks between the circular holes are first punched away where necessary. At the modeling stage this is done with hand tools, and at the production stage it is done with a

punched-tape-controlled machine. Figure 3 shows a typical circuit pattern at the production stage. The outer edges of the basic pattern still remain and serve two purposes. First, the square holes near the outer edges are used for transport through the automatic machine. Second, the outer edges are needed to prevent the various parts of the circuit from becoming separated and difficult to handle.

Figure 4 shows the molding that supports the stamped "wiring." It consists of a plate of thermoplastic material covered on both surfaces with cylindrical projections that match the circular holes in the metal tape.

Two interconnection grids of the form of Figure 3 (generally with different patterns) are mounted on this molding, one on each surface. Figure 5 shows a complete assembly of a side

Figure 4—Thermoplastic molding for support of punched metal strips.

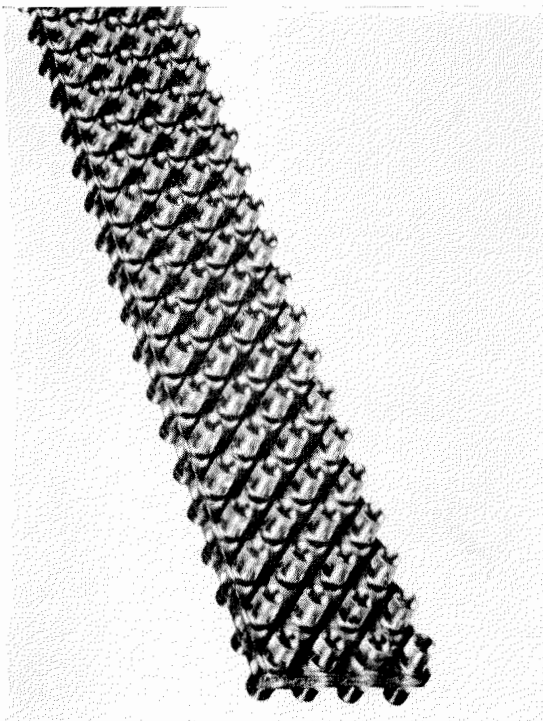

Figure 5—Molding with punched metal strips mounted on each surface to form a side plate.

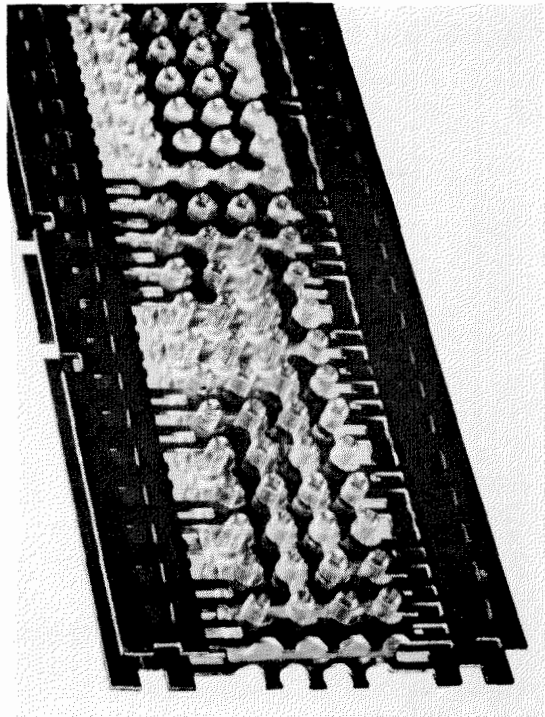



plate. The grids are then held in place by ironing down the tops of the cylindrical projections, as shown in Figure 6. This figure also shows the final modification of the basic material. The outer edges of the metal strip have been cut away, leaving forked soldering tags on the assembly for the attachment of components.

Figure 7 shows two such assemblies, containing different interconnection patterns, joined by terminal plates to form a frame. A double row of small components can be mounted in this frame, or large components can occupy the entire depth.

Details of the terminal plates are shown in Figure 8. Individual terminals are supported on a thermoplastic molding by ironing over the tops of cylindrical projections that mate with

holes in the terminals. The short lugs on the terminals mate with the forked tags on the side plates.

Other methods of providing terminals are shown in Section 5.

The construction described provides on each side plate a maximum of 6 interconnection tracks running in the direction of the length. The 6 tracks are divided into two sets of 3, one set on each surface of the side plate. The planar form of each set of 3 tracks limits the ways in which the main interconnecting tracks can be brought out to terminals for the attachment of components.

Experience has shown that these limits are unimportant for such circuits as triggers, amplifiers, oscillators, et cetera.

### 3. Design

A method of design has been perfected that systematizes the work and leads directly to making a control tape for the automatic machine. The steps in the design process are as follows for the case of a trigger circuit.

(A) The schematic diagram is drawn normally as shown in Figure 9.

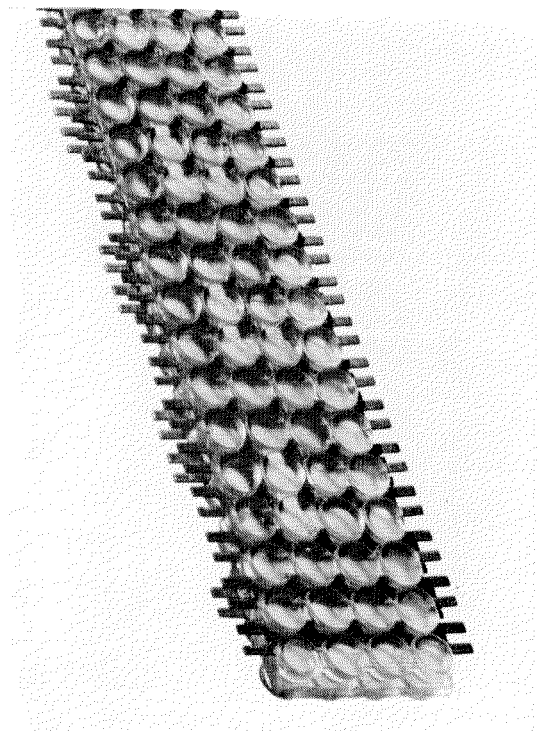

Figure 6—The cylindrical projections are ironed down to hold the grids in place. The outer edges of the metal strips are then cut away, producing the forked soldering tags to which components may be attached.

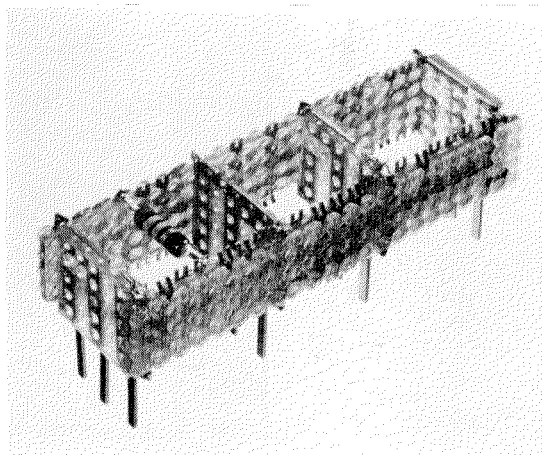

Figure 7—Two side-plate assemblies together with terminal plates make a frame for mounting components.

(B) The interconnection diagram of Figure 10 is then drawn. The components are arranged in a row in approximately the same order as in

the schematic diagram. However, the object at this stage is to make one of the sets of interconnections between components as simple as

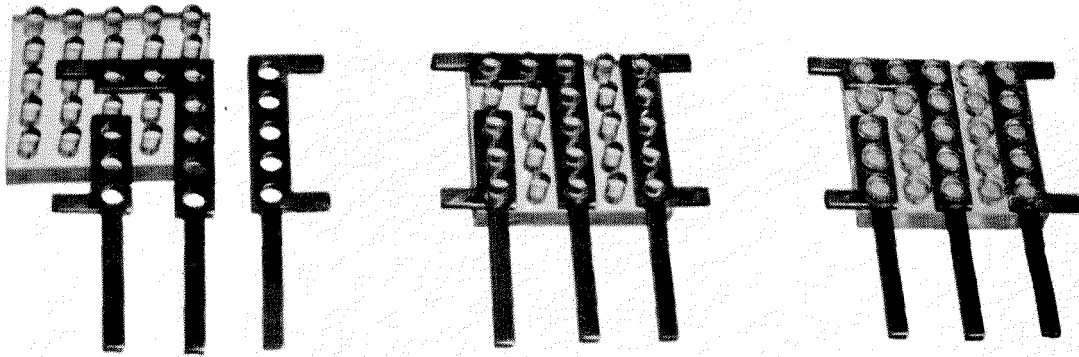

Figure 8—Details of terminal plates.

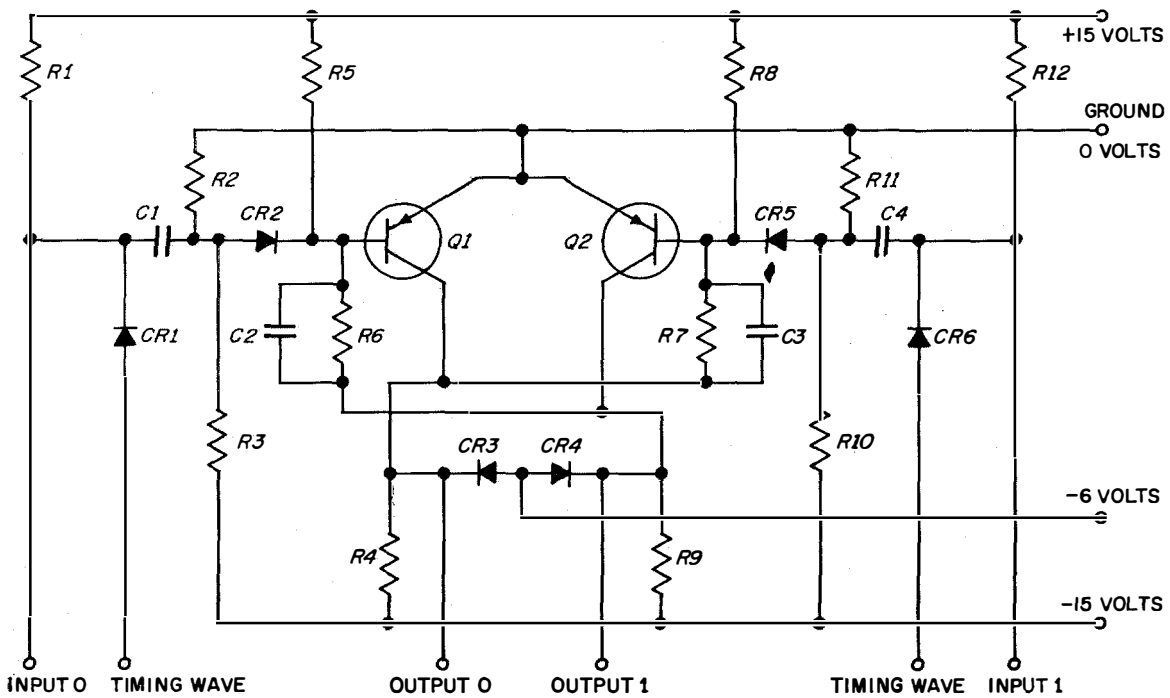

Figure 9—Schematic diagram of trigger circuit.

possible (the lower set in Figure 10). The upper set of interconnections (*X* board) will be constructed on one side plate of the final assembly and the lower set of interconnections (*Y* board) will be on the other side plate.

(C) Next, the packing diagram of Figure 11 and the detailed interconnection diagram of Figure 12 are produced. The components must be arranged to produce good packing and also to make it possible to implement the *X*-board interconnections. Interconnections crossing any vertical line must be limited to not more than three horizontal tracks on each of the two layers of punched wiring. In Figure 12, one layer is drawn in solid lines and the other in dashed lines.

(D) Finally, the *Y*-board interconnections of Figure 13 are designed. These were made very simple in the first approximation of Figure 10. As a result, performing step (C) does not make the *Y* board unduly complicated in practice. It can be seen from Figure 13 that the *Y* board is still relatively simple compared with the *X* board and is well within the scope of the interconnection facilities.

The procedure outlined enables attention to be concentrated as far as possible on one design step at a time. Of course, the time taken for the design process depends on the experience of the designer and the degree of importance of close packing. An approximate time for the circuit illustrated is 4 hours.

#### 4. Manufacture and Modeling

Strip material with the basic interconnection pattern is mass-produced using a high-speed punch press. Moldings and terminals are also mass-produced by conventional means.

The most-important feature of the manufacturing process is the tape-controlled machine that stamps out particular interconnection patterns from the basic strip material.

Basic material passes from a reel to a set of 8 punches. These selectively punch the material, which then moves on to be automatically cropped to length and stacked. The machine operates at the rate of about 12.7 millimeters (0.5 inch) of material per second.

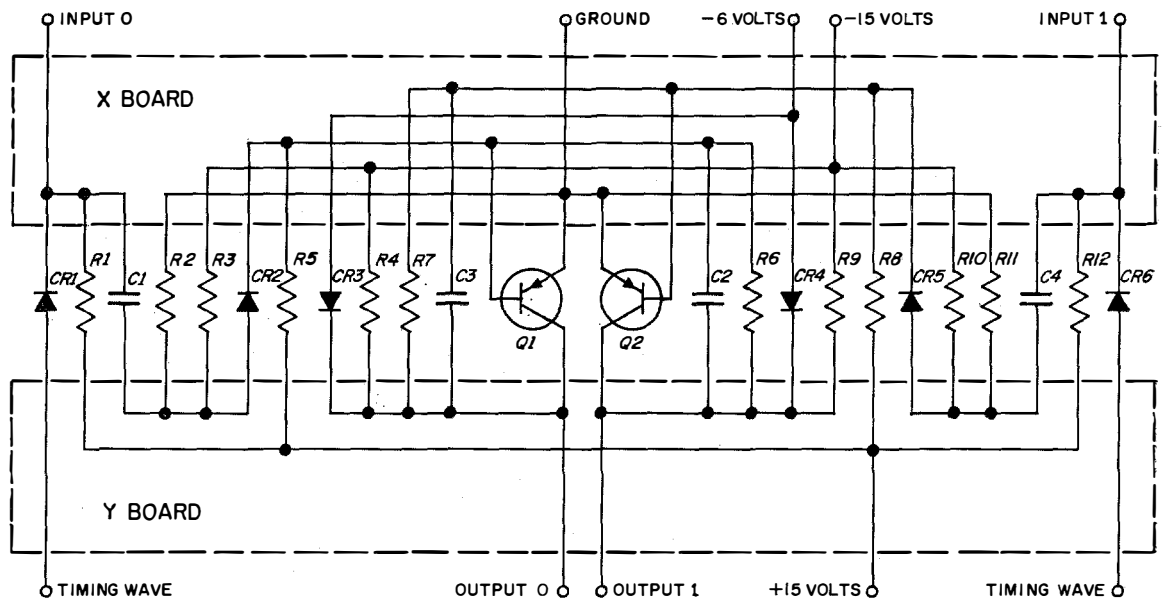

Figure 10—Interconnection diagram of trigger circuit arranged for Ministac.

Control is by means of a loop of 5-channel tape carrying all the information for a set of wiring grids for one module. Two rows of holes across the tape are used to control the 8 punches.

Both horizontal and vertical rows of holes on the basic strip material are on 2.54-millimeter

(0.1-inch) spacing. It is not practical to mount the punches on 2.54-millimeter centers and, to obtain clearance, each is displaced from the next by about 15.2 millimeters (0.6 inch).

Without this displacement the control tape would be a direct analogue of Figures 12 and

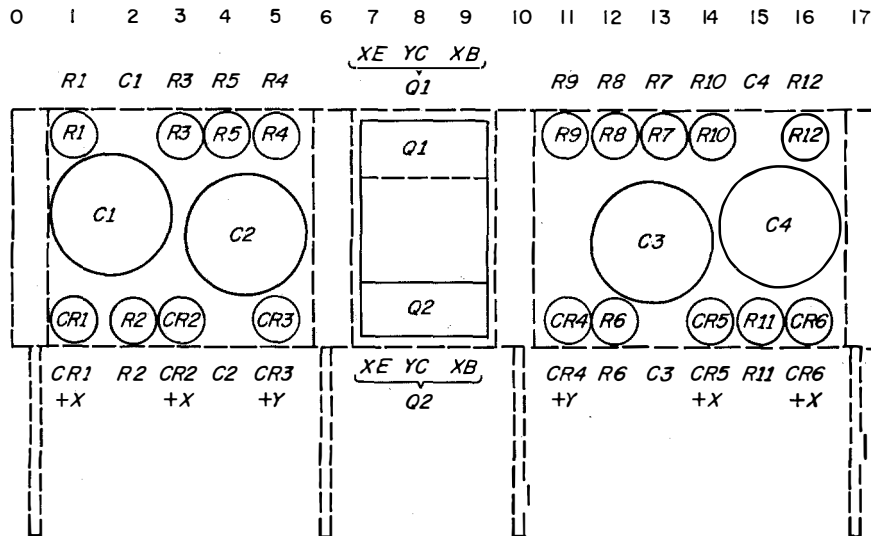

Figure 11—Packing diagram for components of trigger circuit. The numbers across the top (0-17) correspond to the positions of the square holes in the metal tape.

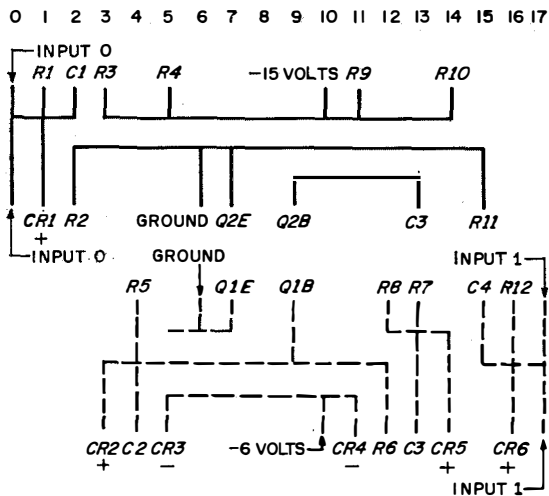

Figure 12—Instructions for punching tapes for the X board. The solid line represents the interconnecting grid for one surface, and the broken line represents the grid for the other surface.

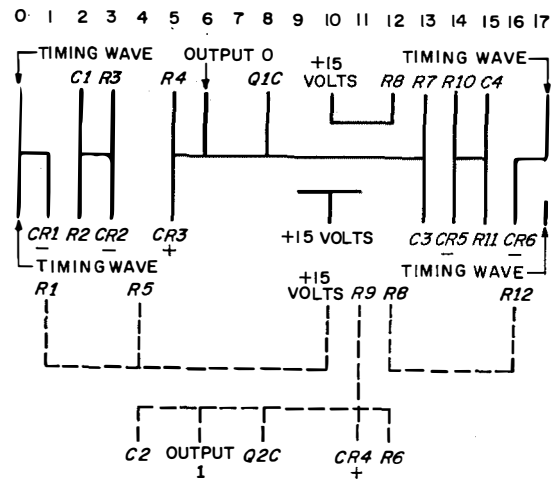

Figure 13—Instructions for punching tapes for the Y board.

13, since the lines on these diagrams indicate where material is to be retained. The displacement of the punches does not cause a serious complication, however, since all that is necessary is to apply a corresponding displacement when preparing a tape from Figures 12 and 13.

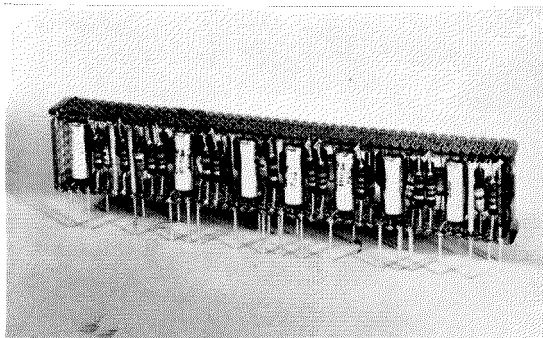

Figure 14—Use of lead-out wires as module terminals. The unit shown is a 4-stage binary counter.

### 5. Applications

The dimensional flexibility, electrical properties, and robustness of Ministac make it suitable for a wide range of applications.

From the description given, it is clear that the parts determining the length of a module can be cut in 2.54-millimeter increments. The punched “wiring” is supplied from a reel and imposes no practical limitations. The molding on which it is mounted is normally in 152.4-millimeter (6-inch) lengths, which is adequate for most requirements. Moldings can be joined together end on end for exceptional applications.

The width of a module can be varied in a similar way, since the molding on which terminals are mounted (Figure 8) can also be cut in 2.54-millimeter increments.

The height of a module is normally 12.7 millimeters (0.5 inch) from the edges of the upper

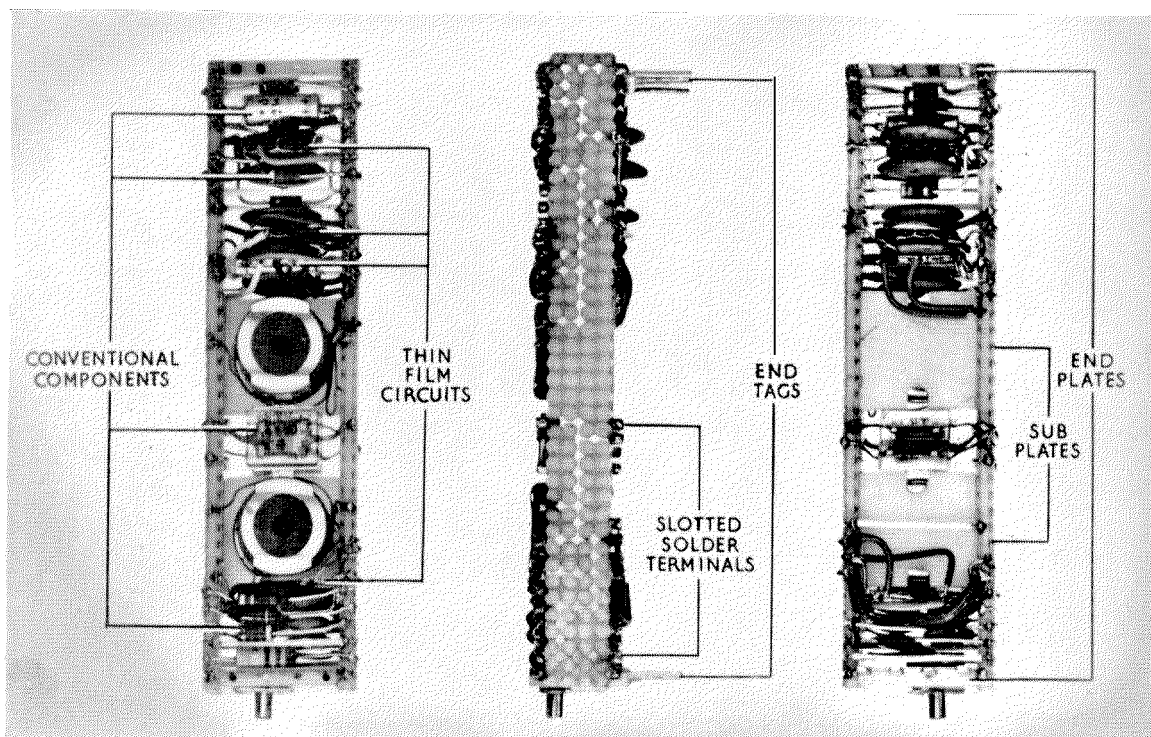

Figure 15—Three views of an intermediate-frequency amplifier combining thin-film circuits and conventional components.

13, since the lines on these diagrams indicate where material is to be retained. The displacement of the punches does not cause a serious complication, however, since all that is necessary is to apply a corresponding displacement when preparing a tape from Figures 12 and 13.

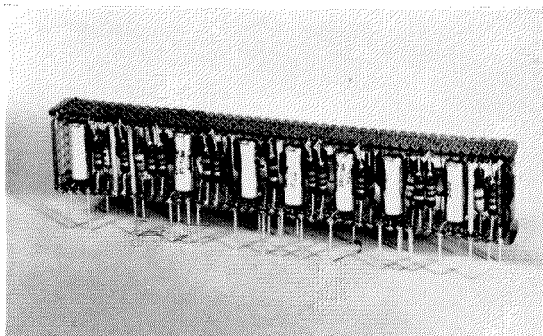

Figure 14—Use of lead-out wires as module terminals. The unit shown is a 4-stage binary counter.

## 5. Applications

The dimensional flexibility, electrical properties, and robustness of Ministac make it suitable for a wide range of applications.

From the description given, it is clear that the parts determining the length of a module can be cut in 2.54-millimeter increments. The punched “wiring” is supplied from a reel and imposes no practical limitations. The molding on which it is mounted is normally in 152.4-millimeter (6-inch) lengths, which is adequate for most requirements. Moldings can be joined together end on end for exceptional applications.

The width of a module can be varied in a similar way, since the molding on which terminals are mounted (Figure 8) can also be cut in 2.54-millimeter increments.

The height of a module is normally 12.7 millimeters (0.5 inch) from the edges of the upper

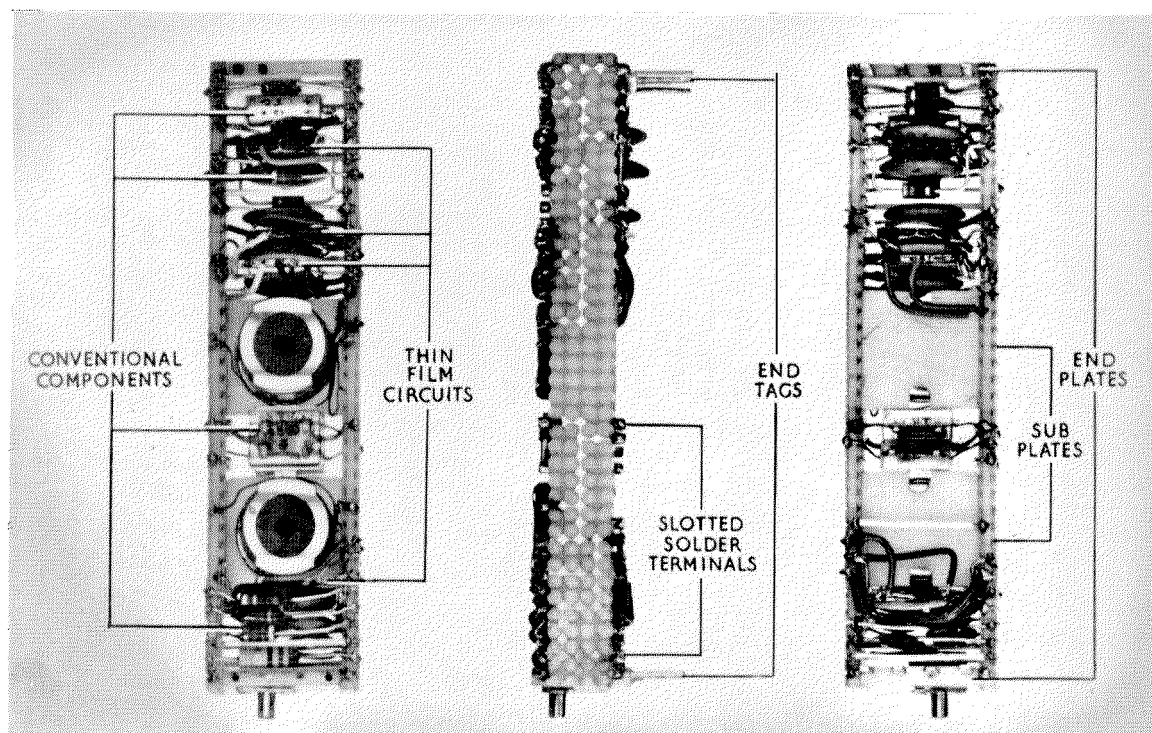
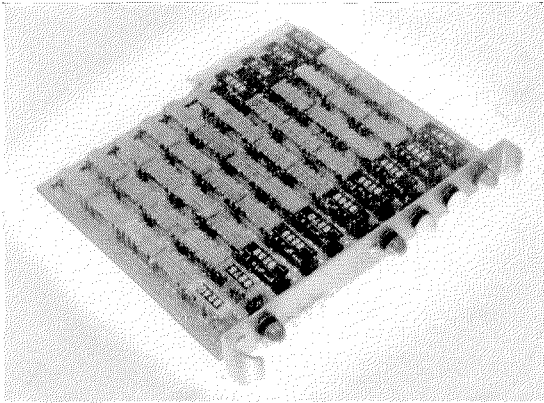

Figure 15—Three views of an intermediate-frequency amplifier combining thin-film circuits and conventional components.

Figure 16—Plug-in board with Ministac modules for use in a digital transmission system.



tags to the edges of the lower tags. Components may project beyond this if they are sufficiently protected from damage.

For most applications, the electrical properties are suitable up to at least 100 megahertz. The capacitance between adjacent parallel tracks on one surface of a side plate is 0.02 picofarad per linear millimeter (0.6 picofarad per linear inch) of strip length. Between two opposite parallel tracks on opposite surfaces of the side plate, it is 0.05 picofarad per linear millimeter (1.4 picofarad per linear inch) of strip length. The loss factor of the stray capacitance is 0.005 at 1 megahertz and 0.01 at 100 megahertz.

Figure 14 illustrates the use of lead-out wires as module terminals. The lead-out wires project beyond the side plates and the module is mounted on its side. This is an economical method of providing terminals and is particularly suitable where a large number of terminals are required.

Figure 15 shows how thin-film circuits can be conveniently combined with conventional components.

Figure 16 illustrates a combination of Ministac modules mounted on a plug-in board for use in a digital transmission system.

Figure 17—Ministac modules mounted together as a unit.

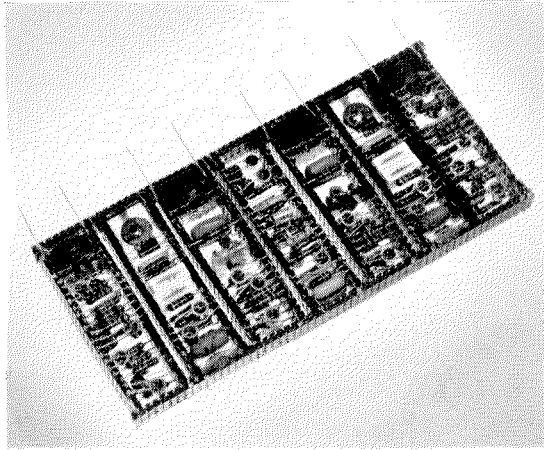

Figure 17 shows how a number of modules may be interconnected by treating each module as a component mounted between a pair of Ministac side plates. The resulting open structure is simple, robust, and compact without any connections or components being inaccessible.

## 6. Conclusions

Starting in 1961, the development of Ministac and its associated automated manufacturing equipment has led to an arrangement for component assemblies meeting a wide range of technical requirements. Engineering has been simplified at the same time.

A tape-controlled production unit for fabricating interconnection patterns is now in operation.

## 7. Acknowledgments

The author is indebted to his colleagues in Standard Telecommunication Laboratories and in the engineering and manufacturing development groups in Standard Telephones and Cables for their assistance in the preparation of this paper.

## Ministac—Component Assemblies

**H. T. Prior** was born at Leigh-on-Sea, Essex, England, in 1916. He studied at Faraday House Electrical Engineering College and received a B.Sc. in engineering from the University of London in 1938.

He joined Standard Telephones and Cables in 1938 where he worked on circuit and system design for line transmission systems. In 1959,

he transferred to Standard Telecommunication Laboratories and returned in 1961 to Standard Telephones and Cables. He is now with ITT Europe in the standardizing of equipment practices.

Mr. Prior is an Associate Member of the Institution of Electrical Engineers.

---

### **Kramar Receives Pioneer Award**

The Professional Technical Group on Aerospace and Navigational Electronics of the Institute of Electrical and Electronics Engineers conferred its 1964 Pioneer Award on Ernst Ludwig Kramar of Standard Elektrik Lorenz. It recognizes his technical contributions to instrument landing systems and is also a tribute to his inventiveness in other areas of radio navigation including Sonne (Consol), radio ranges, and direction finders.

After receiving a doctorate in engineering from the Technical University of Dresden in 1927, Dr. Kramar started his career in C. Lorenz, now Standard Elektrik Lorenz. He is presently Director of Development of Radio Aids to Navigation, having been active in this field since 1930.



# Standard Equipment Practice for ITT Europe

## F. BEERBAUM

Standard Elektrik Lorenz AG; Stuttgart, Germany

## J. EVANS

Standard Telephones and Cables Limited; London, England

## F. LEYSSENS

Bell Telephone Manufacturing Company; Antwerp, Belgium

### 1. Introduction

A standard equipment practice has been developed by a team of engineers from ITT Europe as a guide to our European companies in the design of communication and other electronic equipment. The scope of the project, as shown in Figure 1, involves constructions ranging from suites of racks down to plug-in cards. Guidelines of construction were made broad enough to permit economical manufacture of most required equipments.

To define the problem, a working party collected information and specifications on conventional engineering of racks, subracks, assemblies of parts, and connectors. Study of this material, plus agreement on a design philosophy, gave rise to a general specification used as a basis for the practical design. Details of the design considerations are given in Section 4.

A well-considered equipment practice is useful in the design of any particular system since it reduces the workload by providing a range of

basic parts from which the appropriate ones are chosen. The tooling to make basic parts can be done in advance so that the parts can be produced quickly.

Concentration on these manufacturing problems provides further advantages over more-specialized equipment practices. Intercompany cooperation in equipment design and manufacturing is simplified, and installations may mix different types of product in an orderly way.

### 2. Description

A study of the problems encountered in building electronic equipment indicates a substantial similarity of requirements for all such equipment. Construction generally differs in the arrangement of basic parts and the provisions for their interconnection, test, and maintenance.

The task of the equipment designer is to provide a simple and flexible method of associating units so that the functional and structural parts

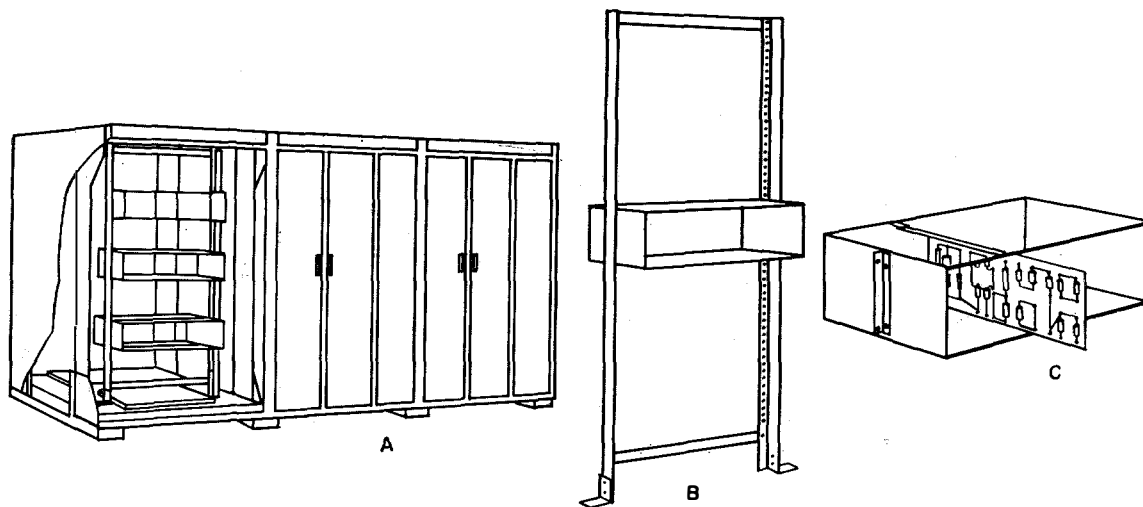

Figure 1—Scope of equipment practice. *A* illustrates a suite of racks with enclosures, *B* a rack with 1 subrack, and *C* a subrack with 1 plug-in card.

can be separately made and tested and progressively assembled into racks, cabinets, or complete systems.

### 2.1 PARTS ASSEMBLIES

In the standard equipment practice, acceptable mechanical designs of parts assemblies can vary widely; the degree of mechanical complexity depends on the types of parts, their packing density, and the accessibility requirements for maintenance. A wide range of standard dimensions is available for all assemblies, whether a simple board with directly mounted parts or an elaborate unit.

It is not the purpose of this paper to discuss the relative merits of the various ways to mount components on cards and make interconnections. The methods commonly used, such as printed-circuit wiring and wrapped solderless joints, are all acceptable and the preferred method can be chosen for a particular product.

Figure 2 shows construction details of a typical simple unit. The printed board is designed and produced by conventional methods and is strictly rectangular in shape. The plug requires only round holes for attachment to its board and is treated as a component for the soldering process. In principle, the plug consists of a piece of insulating material 1.5 millimeters ( $\frac{1}{16}$  inch) thick with toothed edges that estab-

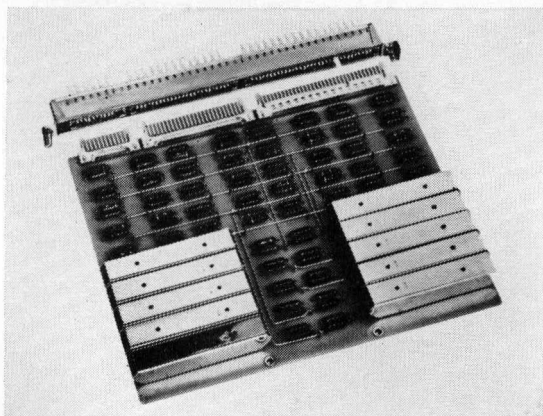

Figure 2—Typical approved parts assembly with 3 plugs, and mating sockets mounted in socket support.

lish the positions of the male contacts. This arrangement has the following main features.

(A) Boards of different thickness do not require different sockets.

(B) No special processes need be applied to the board to produce the plug contacts.

(C) Improvements in materials or changes in requirements permit contact and insulating materials to be changed at any time without changing the board specification.

(D) The teeth are machined to close tolerance, making them substantially independent of board distortion. This is particularly important when considering a large number of connections to a board, as each plug assembly will only be reliable to the extent that its tolerances are controlled. Sockets may also be floated to accommodate interplug tolerances.

### 2.2 SOCKETS AND SOCKET SUPPORTS

Figure 2 also shows a socket support containing three sockets. The support consists of two identical side members and two identical mounting brackets equipped with captive screws. Regularly spaced slots in the side members allow sockets to be fixed in various positions by means of *T*-shaped fixing strips. This arrangement has the following main features.

(A) The board is selected from a range of regularly dimensioned heights, and the number of connections to be accommodated in the socket support varies. The socket side members are readily cut to any height from standard stock.

(B) When the connectors do not take up the entire height of the over-all assembly, those used may be positioned conveniently for the board wiring.

(C) Because the dimensions are such that the socket has vertical float about the *T* strip and because the plug's insulated comb has tapered protrusions, the total of the plug-to-board, socket-to-support, and subrack height tolerances are accommodated by vertical movement

of the socket. Unnecessary friction leading to higher insertion forces is avoided.

(D) When more than one plug-and-socket combination are arranged in line, the tolerances of each combination are mutually independent.

(E) The weight of the board is always supported by the guide rails, not by the socket.

Tolerance variations in the horizontal axis are accommodated by tapered entries in the socket molding. These accept the plug protrusions, aided by the floating arrangement of the socket springs [1].

### 2.3 SUBRACK

The subrack can be made in aluminum or steel to suit the preferred manufacturing method. Since over-all dimensions are standard, the subracks are interchangeable and the same locating, guiding, and connecting parts may be used.

The internal space of this subrack, which is a rectangular frame, can be adjusted to cover a wide variety of sizes within the standard range.

By judicious placement of the horizontal rails together with this simple modular construction, many different combinations of assemblies and parts can be accommodated.

The steel subrack illustrated in Figure 3 consists of four identical horizontal rails joined by two side plates of steel sheet 1.5 millimeters ( $\frac{1}{16}$  inch) thick, using resistance welding. The horizontal rails have tapped holes at regular intervals along their length. The steel parts are galvanized and chromated.

The aluminum subrack (also illustrated in Figure 3) consists of four horizontal extruded aluminum-alloy rails joined by captive screws to two aluminum-alloy side plates 3 millimeters ( $\frac{1}{8}$  inch) thick. The horizontal extrusions have slots in which insert strips may be fitted. These insert strips have threaded holes regularly spaced along their length. The aluminum-alloy parts normally are not treated with any surface finish.

Each subrack side plate is equipped with a right-angle vertical mounting strip. This upright is used to mount the subrack in the rack by screws and nuts.

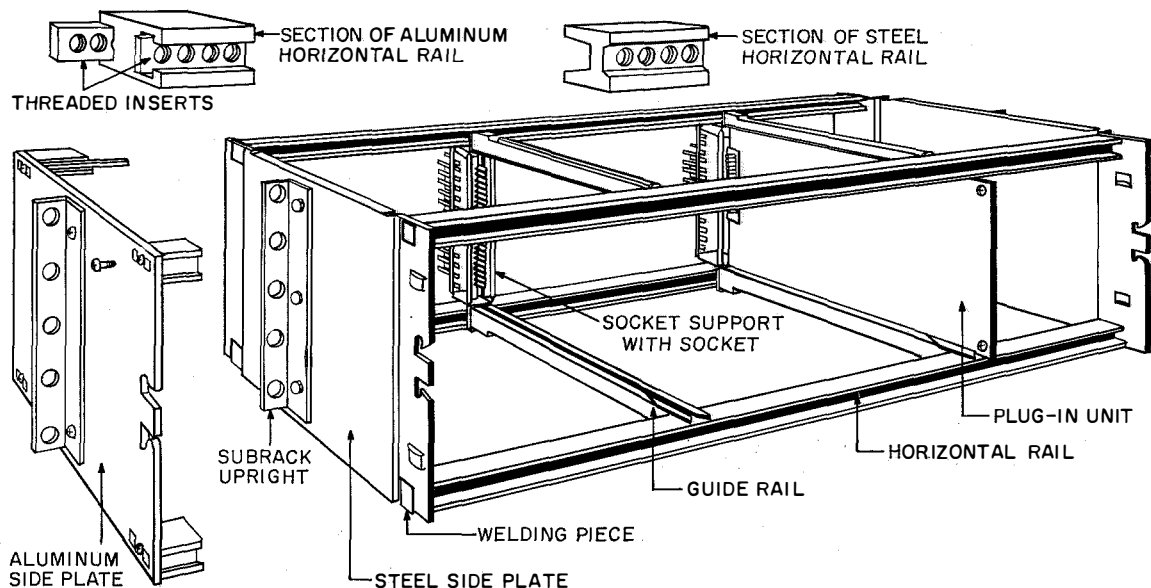

Figure 3—Construction details of steel and aluminum subracks.

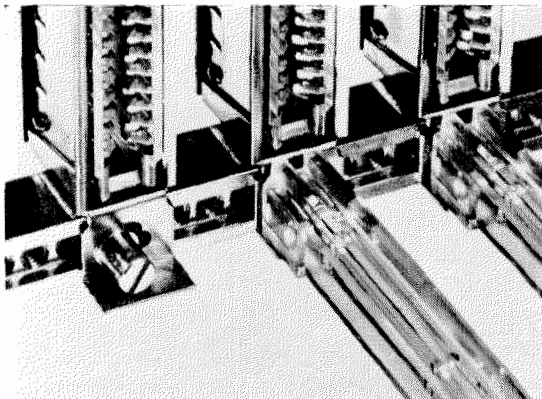

Figure 4—Mounting of socket supports and guide rails on the subrack.

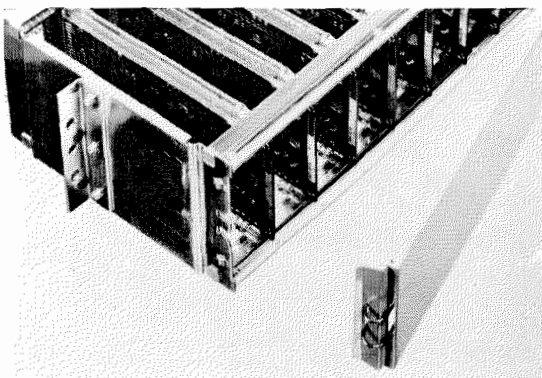

Figure 5—Detachable subrack front cover.

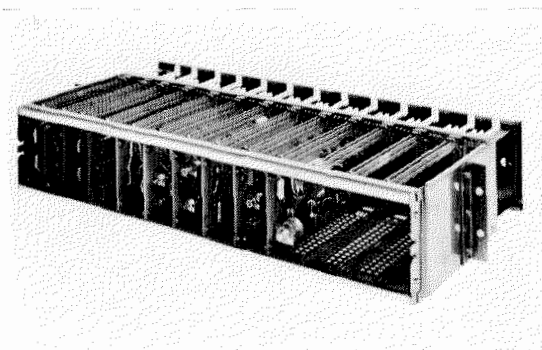

Figure 6—Subrack using post-type wiring guides.

Figure 3 also illustrates how the assembly of Figure 2 is accommodated in the subrack, supported by two plastic guide rails. Figure 4 shows the method of joining the socket supports to the rear horizontal rails of the subrack by means of captive screws. The guide rail is supported on the screw and located on the flange of the socket support. The front ends of the guide rails snap onto the heads of special screws affixed to the front horizontal rails of the subrack. The guide rails, which are narrow to permit optimum air circulation, may be inserted and removed manually without the aid of a special tool. Depending on the assembly-board thickness, the width of the groove in the guide rail is 1.5 or 2.4 millimeters ( $\frac{1}{16}$  or  $\frac{3}{32}$  inch).

The front face of the subrack may be enclosed by the cover shown in Figure 5. The locking springs protruding from the sides of the cover serve as handles and provide good metallic contact between subrack and cover. The rear face may also be enclosed by a bracket-mounted cover.

Figures 6 and 7 show partially equipped subracks, which are fitted with designation strips. Two types of strip are available, each of which snaps directly into the slotted horizontal rail. The first is a transparent envelope into which is inserted a paper strip bearing the identification markings, and the second is an opaque extrusion on which markings may be placed directly. Figure 6 also shows wiring guides, each consisting of a molded plastic post that may be attached by a screw to any one of the holes in the rear rail. Figure 7 shows a second type of wiring guide consisting of a molded comb that may be attached by screws to two of the holes in the rear rail. If necessary, both types of wiring guide may be used in the same subrack.

The subracks are well suited for mounting conventional units. For example, controls and indicators, either panel or bracket mounted, may readily be attached to the horizontal rails.

For mobile use, the assembly boards may be locked by screws to the horizontal rails.

Subrack construction features include the following.

(A) Single- or double-depth subracks. An example of the latter is shown in Figure 8. Intermediate horizontal rails are attached across the top and bottom between the side plates.

(B) A limited range of standard board heights, in optional association with front-mounted units. Figure 9 shows an example.

(C) Fixed or hinged front covers.

(D) Adapters for mounting standard subracks in racks of other dimensions.

(E) Extension of the subrack upright so that several subracks may be mechanically joined and wired together before being mounted in the rack.

#### 2.4 ELECTROSTATIC SCREENING

Three types of screen can be provided as follows.

(A) The subrack screen, which can be seen in Figure 6, may be added to an equipped subrack at any time in the assembly process. This screen is placed horizontally on the top or bottom face of a subrack and shields units in adjacent subracks. It consists of a perforated metal plate allowing adequate passage of cool air; there are terminals at regular intervals along the rear edge for connection of a ground wire.

(B) The independent interboard screen, which may be added to an equipped subrack at any time. This screen is placed vertically between assembly boards at a fixed distance from the wiring side that faces it. The screen, which shields adjacent boards, is mounted between a pair of board guides. It consists of a flanged and shaped steel plate with a ground terminal at the rear, and an extra wire must be provided for this connection.

(C) The board screen, which must be considered when designing the assembly board. It

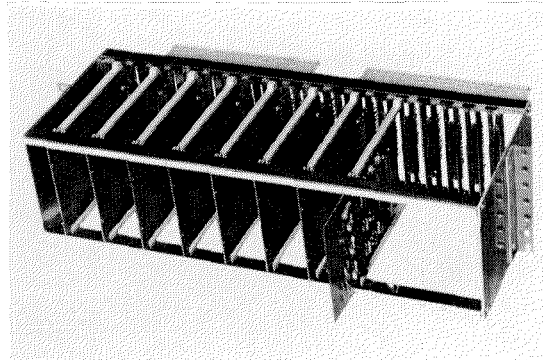

Figure 7—Subrack using comb-type wiring guides.

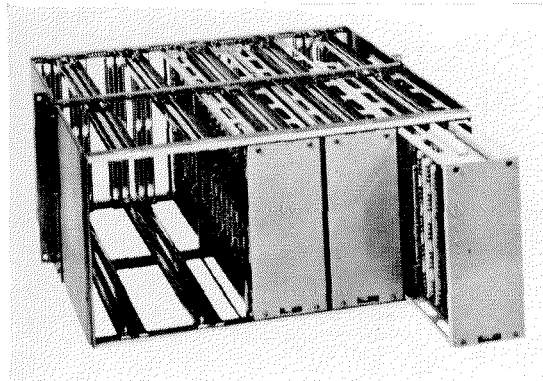

Figure 8—Double-depth subrack.

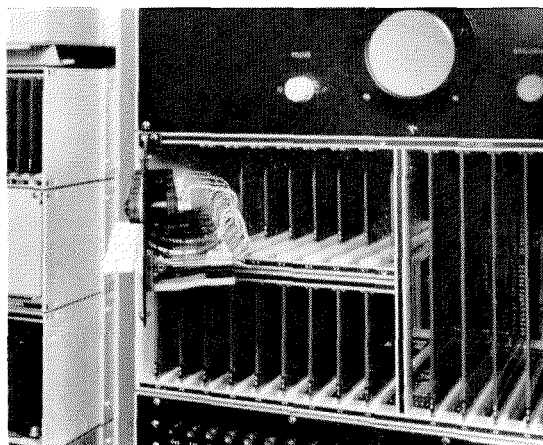
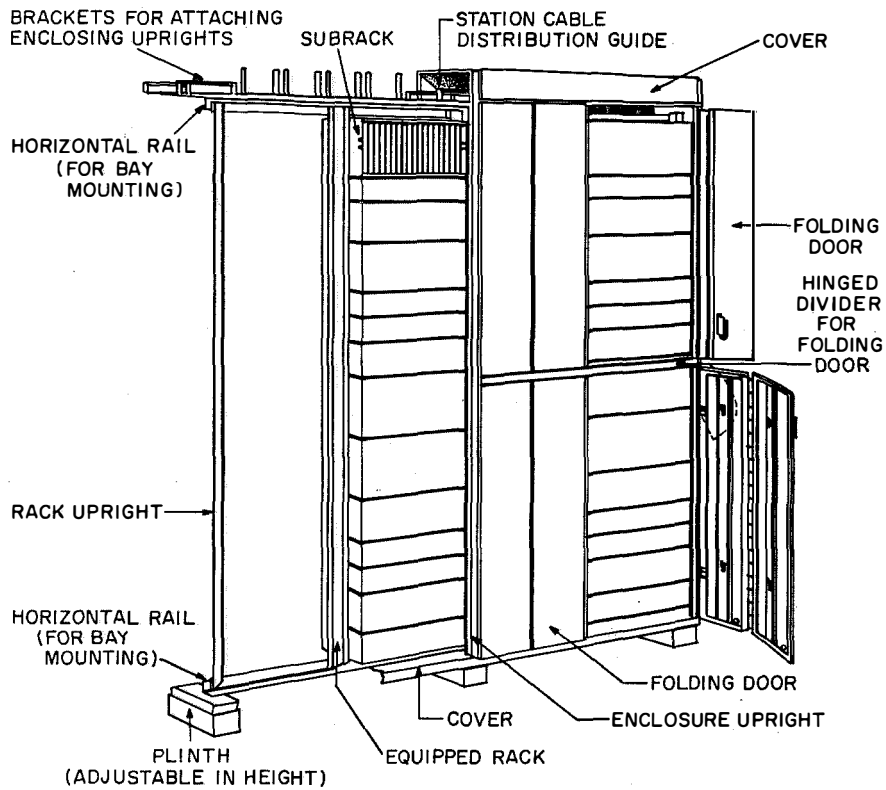

Figure 9—Height-split subrack.

Figure 10—Construction details of rack and enclosure.



consists of a formed steel cover joined to the assembly board. The ground connection is completed to a printed conductor on the board. This conductor is terminated at an allocated contact of the connector to which the system ground goes. The board screen may be mounted on the wiring or component side of the board and shields adjacent boards as well as boards in nearby subracks.

### 2.5 RACK AND ENCLOSURE

The increasing use of miniature units means that the system wiring occupies an increasing proportion of the required space. Hence, an important feature is the provision of an adjustable space for the cabling.

The rack-and-enclosure arrangement, consisting of standard steel elements in modular dimensions, is intended to serve both small and

large installations. For the former, the rack and enclosure is often freestanding with floor-level cabling. In the larger installations, the cabling problem is highly significant. In both cases, the dimensional flexibility of the enclosures allows the ratio of component space to wiring space to be adjusted by choosing appropriate cabinet depth.

In the construction shown in Figure 10, there are plinths to which a bottom horizontal rail is joined. Two rack uprights are joined by two horizontal sections, and the combined frame is attached between the bottom horizontal rail and another at the top. A number of frames may be attached side by side between these rails, which have holes with standard spacing. The rack uprights have regularly spaced holes to accept a flexible complement of subracks. The plinth is adjustable in height to compensate for floor irregularities.

A cable distribution guide is attached to the top horizontal rail. Covers for the cable guide and doors for the rack are optional and may be added to an installation in which the subracks are first fitted with individual covers. Enclosure uprights are joined to the main structure at top and bottom and lift-off hinged steel doors attached. End covers may be attached, and in this case function as enclosure uprights. A more-elaborate version of the end cover can be constructed as a so-called side mounting plate on which the fuses, indicators, and controls may be mounted.

A feature of the design is that the enclosure is fully independent of the framework structure. The system may be installed, cabled, and tested without the enclosure, reducing the risk of damage and increasing access during installation. Another feature is the fact that up to 1.5 meters (5 feet) of framework width may be exposed without intermediate door supports. One-piece doors are used up to a height of approximately 2 meters (6.5 feet); higher enclosures use stacked doors, as shown in Figure 10. When two doors are stacked, they are separated by a horizontal door divider, which may be hinged and swung down to facilitate maintenance.

The doors are made narrow for esthetic reasons and can be folded back to avoid undue restriction of aisle width. The door sections are available in three rather closely spaced widths. As folded and single doors may be mounted in combination, a variety of enclosure widths may be used. A typical combination is shown in Figure 11.

Figure 12 illustrates an alternative to the door-type enclosure. Subracks, each equipped with front and rear covers, are mounted in racks and operate in this configuration. The front covers may be omitted when sealed or suitably shielded assembly boards are specified.

## 2.6 WIRING

Although any type of system wiring may be used, study was primarily centered on conven-

tional wiring methods. Direct point-to-point connections are impracticable in systems with high cable density, even if the mutual capacitance of cabling in high-frequency systems is not a serious factor. The combined subrack,

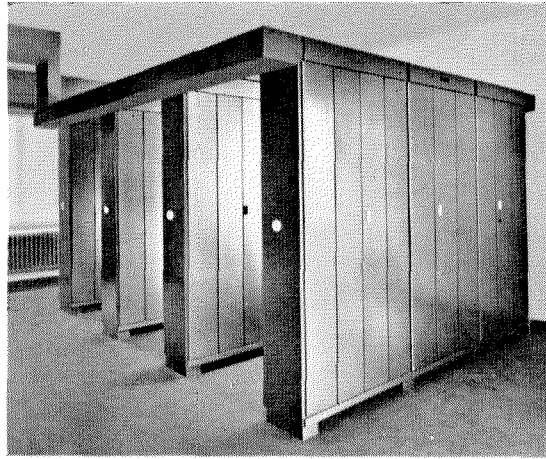

Figure 11—Door combinations for enclosures of different widths.

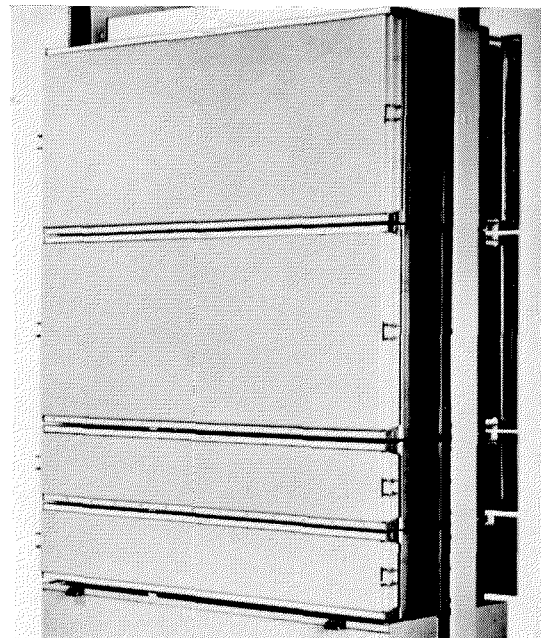

Figure 12—These covered subracks may be used without enclosures.

rack, interrack, and station wiring would be too bulky and complex.

A good compromise is obtained in such cases if the rack wiring is a conventional cable harness terminated at a rack terminal field, or if point-to-point wiring via wiring guides is used, as shown in Figure 13. The latter method provides good access to all connection points and permits the wires to be laid only once instead of first being laced into a harness.

In both cases, the feature of rack-to-enclosure variable width ratio permits wiring that cannot be accommodated behind the rack uprights to spread into the space between rack uprights. The system wiring between racks, between suite frameworks, and from the station cabling, is normally located in the distribution guide at the top of the rack and is covered by front, rear, and top lift-off plates. The construction also allows cabling to be run through floor-level ducts,

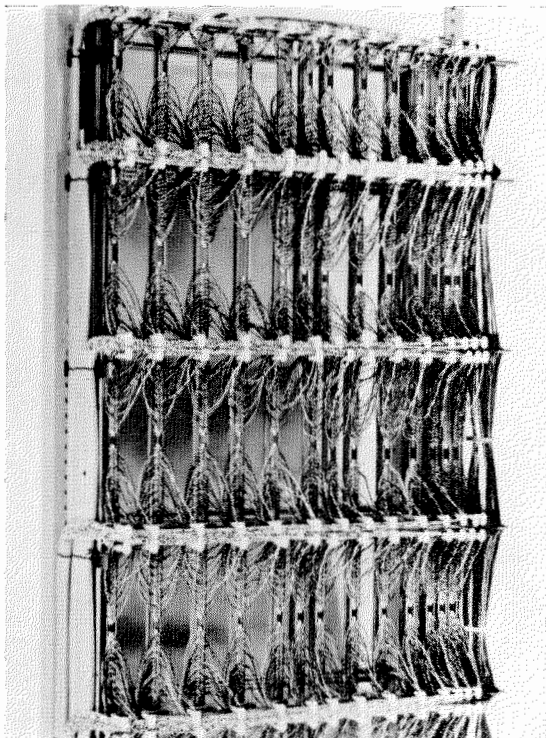

Figure 13—Point-to-point rack wiring using post-type wiring guides.

or under a false floor with the plinths standing on the real floor.

### 2.7 HINGED RACKS

Figure 14 shows a version of the rack and enclosure that embodies 1 fixed and 1 or 2 hinged racks, all equipped with standard subracks.

The construction is compact, rigid, free-standing, attractive, and compatible with office furniture and equipment. The enclosure has the same depth as the general-purpose enclosure, and both types may be joined side by side to form a suite.

Each of the hinged racks gives access at front and back when swung out and is arranged to minimize the traverse of the movable wiring. A terminal panel is mounted near the hinge to obtain the latter result. Fixed panels for mounting controls and indicators may be located at the opposite side of the rack.

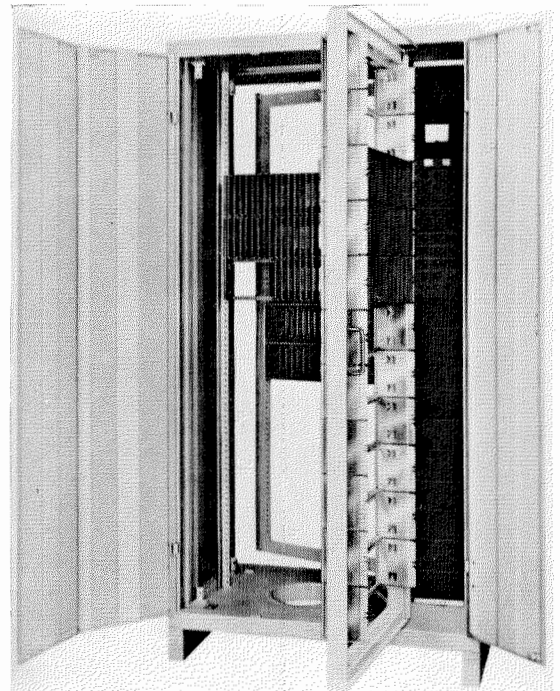

Figure 14—Typical rack-and-enclosure design for hinged racks.



### 3. Applications

The range of design features and permissible dimensions allows a wide variety of applications. The design of assembly boards is mainly controlled by modular dimensioning so that it is possible for the subrack to accept them in any required combination.

Figures 15 through 18 show additional techniques used to build structures ranging from small units up to complete racks of equipment. The details of construction can be adapted to make these structures compatible with existing equipments.

### 4. Design Principles

There is at present a significant trend toward integrated electronic systems that combine several subsystems (for example, data processing, switching, and transmission) into one complex.

In such cases, a uniform equipment practice is particularly valuable from the system engineering, installation, and maintenance viewpoints.

There is also a trend toward greater similarity among different types of product, brought on by the application of semiconductors and associated components, printed wiring, and other modern techniques.

There are many ways to meet the technical requirements of products that have different points of superiority. However, one broad solution may not give equal weight to their respective merits. It is therefore important that the solution have sufficient over-all advantage to be economically acceptable despite the occasional compromise demanded by use of a particular product.

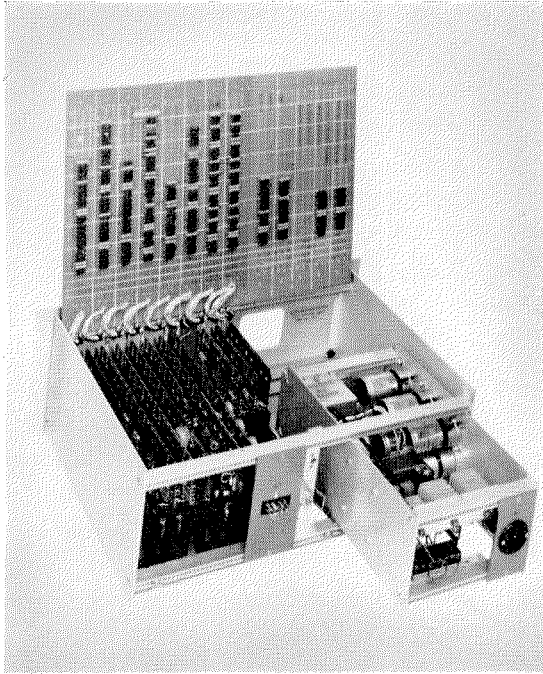

Figure 15—Alternative way of mounting assembly boards. Note that the power unit is a separate subrack that slides into the main subrack. The over-all unit mounts on a standard 483-millimeter (19-inch) rack.

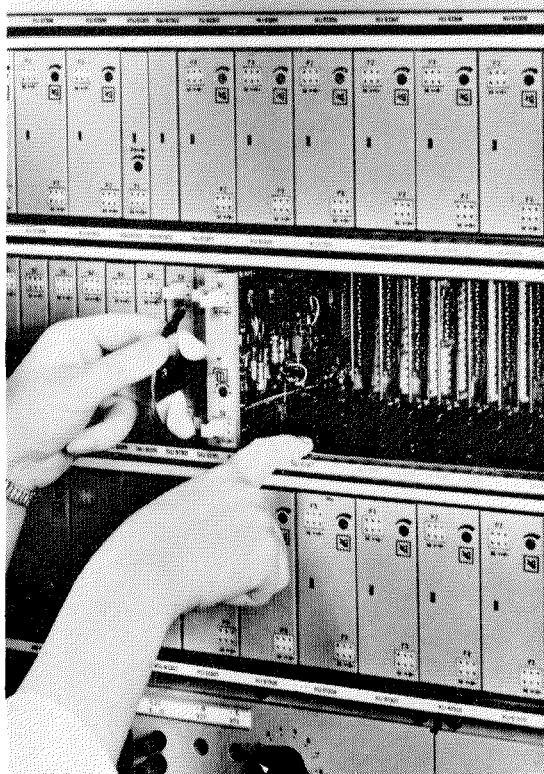

Figure 16—Release and extraction of an assembly from a subrack.

Although a certain degree of design discipline is essential, engineering freedom of decision within the system must not be restricted by excessive standardization. Examination of product differences clearly shows that there can be no single set of values for dimensions of the mechanical parts; therefore it is important that standards for construction and dimensions be made as flexible as possible.

The approach to these objectives has been to design parts, within modular dimensions, that may be assembled into a variety of structures. These parts (for example, end plates and rails for subracks) can either be stocked in a range of modular sizes or fabricated as required from basic material with tooling adaptable to various needs.

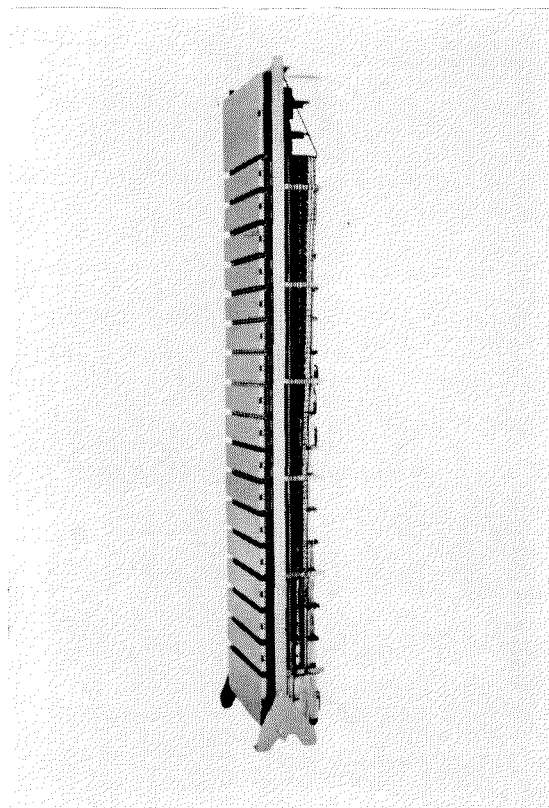

Figure 17—Fully assembled and wired rack using subrack covers.

This approach simplifies engineering drawings, manufacturing methods, and training of operators, and also reduces indirect costs.

Another design principle has been to develop standards compatible with concurrent manufacture of the various parts. For example, assemblies, subracks, and racks can be manufactured at the same time, with consequent saving of over-all time and reduction of investment charges.

### 4.1 GENERAL SPECIFICATION

This section summarizes the requirements that apply to the joining of components into units, and the assembly of such units in subracks and racks. Requirements encompassed by the equipment practice include the following.

(A) Applicability to electronic and electro-mechanical systems including switching, line and radio transmission, data processing, telegraphy, signaling, remote control, and telemetering.

(B) Adaptability to automated production of the equipment, especially for soldered or wrapped wiring and for component mounting.

(C) Identification of and convenient access to all components and their connections for ease of testing and maintenance.

(D) Combining of conventional parts and printed boards, which may also be of the plug-in type.

(E) Effective heat dissipation by natural or forced cooling.

(F) Standard dimensions to permit advance production of parts for stock and rapid fabrication to order with established tools. This permits early delivery of equipment.

(G) Standard dimensions selected to conform with dimensions of existing equipment.

(H) Minimum engineering in developing new systems.

(I) Conformance to recommendations of the Comité Consultatif International Télégraphique

et Téléphonique [2] and the International Electrotechnical Commission.

(J) Electric shielding of units, subracks, racks, and cable groups.

(K) Adequate grounding where needed.

(L) Equipment enclosures that may be added after installation, wiring, and testing.

(M) Protected cable ducts for wiring between racks.

(N) Full guidance of plug-in boards during replacement to avoid accidental contact with adjacent units.

(O) Units may be open wired boards, shielded, hermetically sealed, or of chassis type for heavy components.

(P) Units are locked against movement, particularly for mobile use.

#### 4.2 CONNECTOR SPECIFICATION

Many details of construction are determined by the plug-in connection. Therefore, the minimum acceptable requirements are listed in this section and refer in particular to the plug attached to the printed board or other unit and to the associated socket mounted in the subrack into which the unit is plugged.

##### 4.2.1 Dimensions

(A) Contacts shall be on 2.54-millimeter (0.1-inch) centers in accordance with International Electrotechnical Commission Publication 97; 1957.

(B) Connector contacts of printed boards, or plugs attached to printed boards, shall be suitable for board thicknesses of 1.6 and 2.4 millimeters ( $\frac{1}{16}$  and  $\frac{3}{32}$  inch), derived from the publication cited in (A).

(C) Socket terminals shall permit soldering or shall accommodate up to 3 wrapped connections of wire 0.6 millimeter (0.023 inch) in diameter.

(D) Unused space between plugged-in units shall be kept to a minimum.

##### 4.2.2 Mechanical Features

(E) Wherever practicable, connector contacts shall be arranged for direct plug-in to avoid bending the board.

(F) Plug-in force shall be as low as possible.

(G) Connector life shall be a minimum of 10 000 plug-in actions.

(H) Contact points shall be protected against damage during board manipulation.

(I) Plug assemblies shall be in a minimum number of sizes. The number of contacts for each size of plug, in combination, shall be suitable to provide for the entire range of board sizes.

(J) There shall be small variation of contact force and contact pressure.

(K) Contact springs in the sockets shall be conveniently replaceable.

(L) There shall be a floating arrangement of sockets or socket springs in both vertical and horizontal axes, to compensate for board and subrack tolerances.

(M) Plugs and sockets shall not require separate mounting screws.

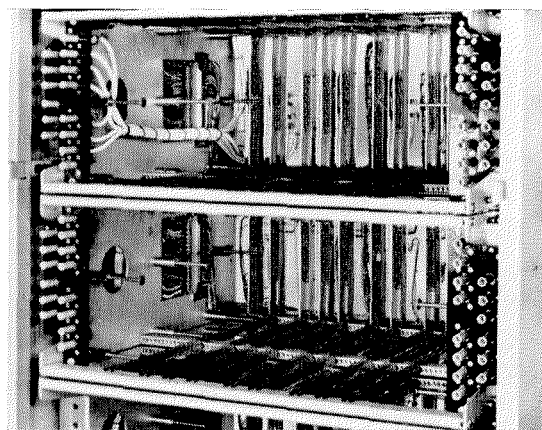

Figure 18—Subracks mounted on rack with provision for connection to the rack wiring by coaxial U links, as well as subrack wiring to rack wiring by connector attached to side plate. This arrangement permits subracks to be prewired and installed at the site.

## Standard Equipment Practice for ITT Europe

(N) There shall be mechanical coding to prevent improper plug-in.

(O) Plugs shall also be capable of being used with metal boards.

### 4.2.3 Electrical Ratings

(P) Continuous contact current shall be 4 amperes minimum.

(Q) Contact resistance shall be 5 milliohms maximum.

(R) Insulation resistance shall be 100 000 megohms minimum (after storage for 4 days in air with a relative humidity of 83 percent at 23 degrees centigrade).

(S) Root-mean-square test voltage shall be 100 volts.

(T) Contact force shall be 60 grams minimum.

(U) Double contacts shall be provided.

(V) Danger of silver migration shall be avoided.

### 4.2.4 Materials Employed

(W) The design shall permit a range of contact materials to be specified without other changes.

(X) The design shall permit a range of insulants to be specified without other changes.

### 4.2.5 Ambient Conditions

(Y) Range of operating temperatures shall be -55 to +100 degrees centigrade.

(Z) The connector shall be tropicalized.

## 5. Conclusion

This practice does not claim to satisfy all the conditions of every system. It attempts within its terms of reference to lay a simple foundation to which may be added, with little engineering and manufacturing cost, the particular requirements of specific products.

## 6. References

1. F. Beerbaum and J. Bernutz, "Multi-pole Printed Circuit Connectors with 2.54-millimeter (0.1-inch) Contact Pitch," *SEL-Nachrichten*, volume 9, number 2, pages 87-93; 1961.
2. Comité Consultatif International Télégraphique et Téléphonique. Recommendation G231, *CCITT Red Book*, volume 3, page 59.

**Friedrich Beerbaum** was born in Berlin, Germany, on 28 March 1908. He is an engineering graduate of Ingenieur-Schule Gauss in Berlin.

From 1929 until 1948, he was employed by Allgemeine Elektrizitäts-Gesellschaft.

In 1948, he joined Standard Elektrik Lorenz where he is presently chief apparatus design

engineer for switching systems and is also concerned with new equipment practices.

**J. Evans** was born in Cardiff, Wales, on 21 February 1924.

After previous technical service with both an aircraft operating company and the Royal Air Force, he joined Standard Telephones and Cables in 1950. He worked on test sets and re-

generators in the Transmission Division. Later he was responsible for product and mechanical engineering during the development of the Zebra computing equipment.

He represented Standard Telephones and Cables in the International System task force on equipment practices. Mr. Evans is now chief mechanical engineer of the Integrated Electronic Systems Division.

**F. Leyssens** was born in Antwerp, Belgium, on 18 September 1930. He received the degree of technical engineer from the Higher Institute de Nayer at Malines in 1953.

In 1957, he joined the Bell Telephone Manufacturing Company as an apparatus development engineer and is its representative in the ITT Europe Standard Equipment Practice group.

# Central Testing Organization Within ITT Europe

C. A. MEULEAU

ITT Europe Technical Office

## 1. Introduction

Our manufacturing companies and laboratories have operated for decades in all major countries of Western Europe. Although these companies had to adapt to different conditions in the telecommunication systems of the various countries, they realized early that rigid standards of high quality for our electrical and electronic components would be beneficial and even indispensable.

This became doubly clear after World War 2, when the European economic communities (Common Market and Free Trade Area) were taking shape.

As one means to further standardize and assure high quality, an ITT Europe Central Testing Organization was started in 1959. As a general policy, all tests are performed according to

standard test procedures, based on existing international specifications if such are available.

Ten test centers have been established in 5 countries (refer to Table 1) and their activities are coordinated from an office in Paris. They provide employment for about 30 engineers and technicians.

Costs, which are centrally controlled, cover not only personnel but also the following:

(A) Test equipment, which frequently is designed and built by the centers,

(B) Purchase of samples from outside suppliers, and

(C) Power, which may be significant when testing power rectifiers, for example.

In addition to detailed test reports, 180 copies of a quarterly condensed summary are dis-

TABLE 1  
DETAILS OF THE CENTRAL TESTING ORGANIZATION

Test Center	Date Established	Location	Notes
Selenium power rectifiers	1959	Standard Téléphone et Radio, Zurich, Switzerland	
Silicon power rectifiers	1959	Standard Téléphone et Radio, Zurich, Switzerland	
Relays	1958	Le Matériel Téléphonique, Paris, France	Received official status in 1959.
Capacitors	1959	Laboratoire Central de Télécommunications, Paris, France	
Transistors and diodes	1959	Laboratoire Central de Télécommunications, Paris, France	
Microelectronic devices	1963	Laboratoire Central de Télécommunications, Paris, France	
Magnetic materials and cores	1959	Standard Telephones and Cables, London, England	Transferred to Standard Elektrik Lorenz, Nuremberg, Germany, in 1963.
Vacuum tubes	1960	Standard Telephones and Cables, Paignton, Devon, England	Located at Standard Telephones and Cables vacuum-tube development laboratories.
Resistors, thermistors, and varistors	1963	Standard Elektrik Lorenz, Berlin-Tempelhof, Germany	
Connectors	1962	Bell Telephone Manufacturing Company, Antwerp, Belgium	In operation for some time before becoming an official test center.

tributed to companies throughout the International System.

Reliability assessment is also an essential activity of the Central Testing Organization. The test centers are making relevant contributions to an over-all reliability program. As an example, they may devise appropriate accelerated methods of determining parameter drifts.

The activities of the test centers are described in the following sections.

## 2. Power Rectifiers

### 2.1 SELENIUM

The test center for selenium power rectifiers is currently making mechanical, climatic, and life tests. To make comparison easier, only single-phase bridge-connected rectifiers having standard plate sizes are tested. The test facilities for mechanical and climatic tests are quite conventional.

The equipment for life tests is more impressive. It has a capacity of 88 rectifier stacks with outputs of up to 24 amperes direct current from each stack, each of which is connected to its own resistive load. This corresponds to installed power of 200 kilovolt-amperes and consumption of 100 kilowatts at the present time.

Because of the heat dissipated in the loads, they are located in a room with appropriate ventilation, whereas the stacks are in a separate temperature-controlled room (35 degrees centigrade) and the controls and measuring equipment are in a third room, shown in Figure 1.

Life tests have great importance because they give the most-useful information, notably data from which life expectations for various ratings can be derived by combined mathematical and graphic extrapolations.

### 2.2 SILICON

At this test center, silicon industrial rectifiers are individually submitted to load tests or

cycled forward-current tests, depending on the particular rectifier. They are also subjected to continuous reverse-voltage, storage, mechanical, and climatic tests.

Tests are made in a single-phase half-wave circuit, using a resistive load. The operation may be conducted at various ambient temperatures. There are 632 positions for load testing. The power supply delivers 70, 140, 280, 420, and 560 root-mean-square volts, respectively, for cell ratings of 100, 200, 400, 600, and 800 crest or peak working volts. The installed power is 700 kilovolt-amperes and present consumption is 250 kilowatts. This large amount of energy is converted to steam in a boiler, which serves the Zurich factory.

Figure 2 shows the test racks and measuring equipment. Measurements of forward-voltage drop and reverse current are made dynamically, without interrupting the test in progress.

## 3. Relays

This test center includes a laboratory for the examination of electromagnetic relays. In addition to test units that determine basic operating parameters, such as operate and release currents and times, the following equipment is provided for special tests.

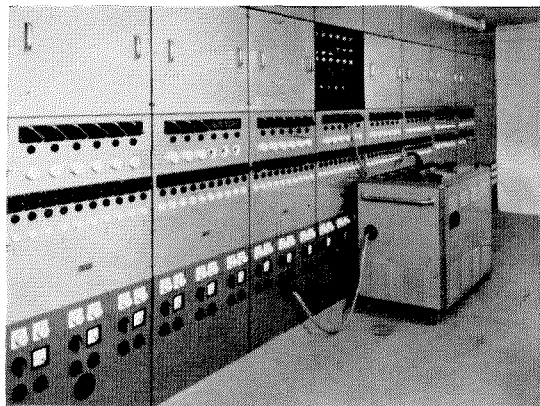

Figure 1—Controls and measuring equipment for life tests of selenium rectifiers.

## Central Testing Within ITT Europe

- (A) Recording oscillographs.
- (B) A high-speed camera (up to 8000 exposures per second).
- (C) An optical bench with a shadowgraph.
- (D) A tensile test machine to record action and reaction forces as a function of armature displacement or air gap.
- (E) Electronic test equipment for high-speed relays et cetera.

The test center has access to the local facilities of Le Matériel Téléphonique for conventional, mechanical, and climatic tests.

The equipment for life tests was completely rebuilt in 1962 and 1963 in accordance with the latest practices of the telephone industry. Figure 3 shows this equipment, which consists of the following elements.

- (A) Power supply (left foreground) regu-

lated within 2 percent throughout the load range.

(B) Square-wave pulse generator producing frequencies of 50, 25, 12.5, 6.25, et cetera, hertz, the first frequency being synchronized with the source power of  $50 \pm 1$  hertz. The others are generated by transistor flip-flops with automatic switchover to standby equipment in case of failure.

(C) Fault-detection system (right foreground) in which the control circuit monitors the square-wave pulse generator to remove from test any sample that fails.

A punched-card device is set up to register failures detected by routine test. The punched cards give information about the kind of failure, the number of operations between the start of the test and the time failure occurred, et cetera.

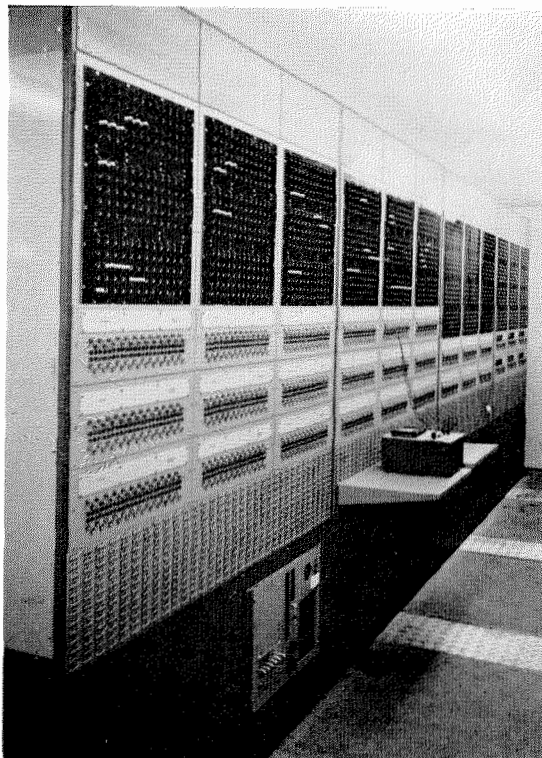

Figure 2—Racks and measuring equipment for life tests of silicon rectifiers.

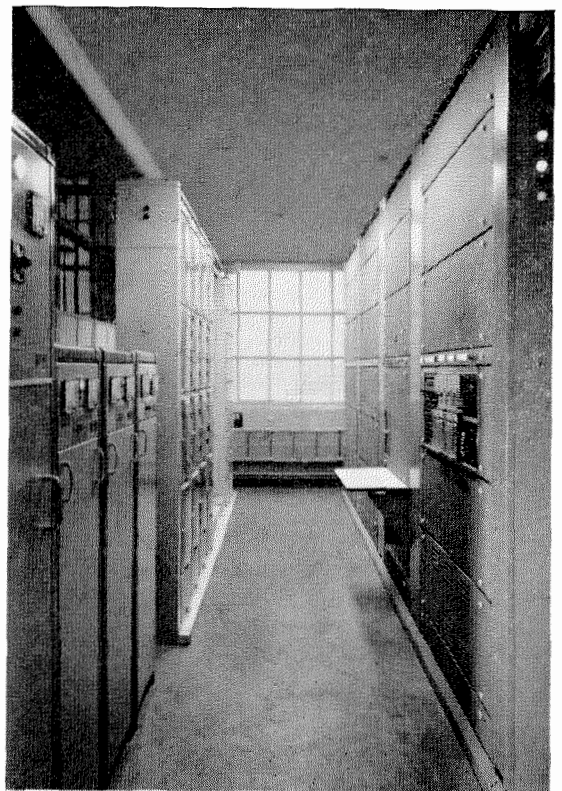

Figure 3—Equipment for life tests of relays.



#### 4. Capacitors

This test center is concerned with all capacitors except those for power applications (power-factor correction, motor starting, et cetera).

The tests are of two main types.

(A) Qualification or type-approval tests are performed on a limited sample, typically 150 units. These tests are quite conventional, notably (1) initial check of dimensions and electrical parameters, (2) mechanical (tensile, vibration, soldering, et cetera) tests, (3) thermal-climatic tests, and (4) life tests. The latter are normally carried out over a limited period of time, typically 1000 hours, prescribed by the relevant test specification.

It is standard procedure to prolong life tests far beyond the specified duration. Indeed, this policy is not limited to capacitors and it has

given extremely rewarding results. Since all samples are subjected to the same tests determined by their ratings, differences in the results are often significant. One brand may show noticeable deterioration after 3000 hours, whereas another may operate satisfactorily after 10 000 hours.

(B) So-called reliability tests are undertaken only if the tests described in (A) are satisfactory. Reliability tests are carried out on larger batches, say, 700 units. These are divided into several groups under different test conditions (3 temperatures and 3 voltages) and the test generally lasts or even exceeds one year. Since the design of the capacitors has been proved by the qualification tests, the number of catastrophic failures normally is small and attention can be concentrated on parameter drifts. Mathematical means are being developed so that the collected data will permit



Figure 4—Equipment for reliability and life tests of capacitors, transistors, and diodes.

## Central Testing Within ITT Europe

extrapolations and predictions to be made for periods of several years.

Equipments used at the test center include ovens, climatic chambers, vibration and shock machines, voltage and current supplies, and oscilloscopes. There are also precision bridges and standards, which are maintained at constant temperature.

All the life and reliability test equipment, shown in Figure 4, has been designed and constructed by the test center. This equipment is installed underground and comprises 19 cabinets, 14 for high-temperature tests (right half and left rear of figure) and 5 for room-temperature tests (left side of figure). Temperature is maintained within  $\pm 1$  degree (up to 200 degrees centigrade) in each cabinet. This equipment is served by a general 10-kilovolt-ampere power supply regulated within  $\pm 1$  percent. Each cabinet has individual power supplies (duplicated for safety), controls, temperature regulators, and recorders. There is also a system of alarms (center of figure) that detects supply and temperature failures, as well as catastrophic failures for each container of capacitors within the ovens.

Another feature of the test center is the development and construction of automatic test equipment. The number of required measurements is so large and the need to remove all

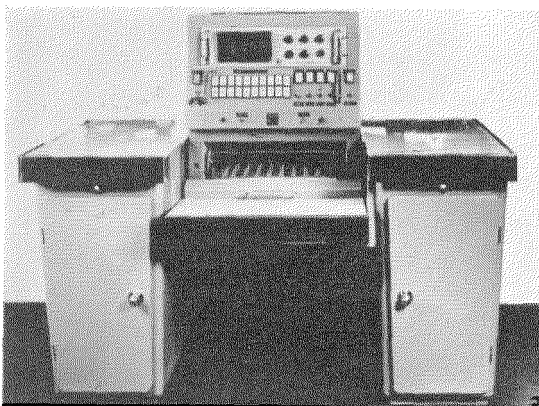

Figure 5—Automatic test console for capacitors.

causes of errors so imperative that automation has become indispensable. Figure 5 shows a measuring console, one of which is used for diodes and another for capacitor leakage currents. Measured values are indicated directly on digital voltmeters as well as being printed on paper tape. In the future they will be directly recorded on punched cards, which will be processed by an electronic computer.

### 5. Transistors and Diodes

The test center for transistors and diodes is located next to the test center for capacitors, with common staff and some common facilities.

Semiconductor devices pose their own difficult problems, which often stem from the rapid evolution in this field. Full evaluation of a transistor or a diode may take one or two years, and on occasion results have lost part of their value when they finally became available. Test programs must be very flexible, and this is a problem at the moment.

Another problem relates to the high reliability achieved, particularly with planar devices. It has been explained [1] why it normally is not practicable to assess reliability on very-large sample batches. It is accepted that central test facilities have to be maintained within reasonable limits and that the usual sample size for reliability assessments on transistors and diodes is 1000 units, providing  $10^7$  component-hours after one year.

Thus, for properly designed and manufactured devices, the inherent long life means that catastrophic failures can be negligible. However, the test conditions applied, involving temperature, voltage, and power, correspond in some way to life acceleration and may cause a significant number of catastrophic failures. The problem is to correlate the test conditions with the failure rates thus determined. A dilemma arises when we try to increase the statistical significance of the results; either to have a few groups of test conditions and many units per group, or many groups of test conditions and

fewer units per group. This problem is widely known, but its solution in the present case must take into account the special aims and limitations of the testing organization.

In any event, attention is concentrated on parameter drifts rather than sudden failures, to a greater extent than for capacitors.

### 5.1 MICROELECTRONIC DEVICES

The activity at Laboratoire Central de Télécommunications has recently been extended to include a test center for microelectronic devices. The new technologies involved require the development of basic test philosophy and detailed test methods. Work has already started on various representative devices and is increasing steadily.

## 6. Magnetic Materials and Cores

The responsibilities of this test center are many and complex because of the variety of magnetic materials and their applications (inductors, transformers, core memories, magnets, microwave devices, delay lines, shields, transducers, et cetera). Particular problems received priority therefore—at least at the start; the test program concentrates on items of direct interest to the main equipment activities of the International System, such as ferrite cores for transmission, switching, and microwave applications. The long-term behavior of these components is of particular importance.

Most of the tests presently concern temperature factors and disaccommodation effects in ferrite cores for transmission. Neither characteristic is regularly tested as part of the supplier's quality control, and statistical evaluation is needed. Another aspect concerns the complexity of magnetic phenomena, so that tests not only check the manufacturer's data but include investigations of additional parameters. Therefore, the test center must maintain close contact with users to determine all critical parameters, and

to discuss with manufacturers the results of investigations in an effort to obtain the best possible compromises among requirements that are more or less contradictory. As do the other test centers, it also must participate actively in the establishment of appropriate test specifications.

The test equipment is conventional but of extremely reliable design. It includes Maxwell-Wien bridges and  $Q$  meters as well as ovens and thermostats ( $-35$  to  $+500$  degrees centigrade) necessary to measure initial permeability, loss factors (Jordan and Legg), hysteresis effects, Curie point, et cetera. In addition, there is an oscillographic equipment to test memory devices, as well as all the microwave equipment necessary to test magnetic properties, attenuation, et cetera, at frequencies up to 7 gigahertz, including special equipment for measuring constants of materials.

## 7. Vacuum Tubes

It was found most practical and economical to locate this center at the vacuum-tube development laboratories of Standard Telephones and Cables. On the same site are manufacturing facilities associated with these laboratories. Therefore much laboratory equipment is available for making apparatus to perform the more-complex measurements required in detailed tube investigations. At the same time, a comprehensive and versatile range of test sets is available in the production area to examine higher-power low-frequency tubes and all the other devices manufactured at this location.

Life tests under varied conditions such as environment, overload, and simulated intermittent operation, play an important part in evaluating a tube type. The vacuum-tube division includes a department to design and produce equipment for this class of testing, and to maintain and periodically calibrate it.

Figure 6 shows a microwave test console in operation.

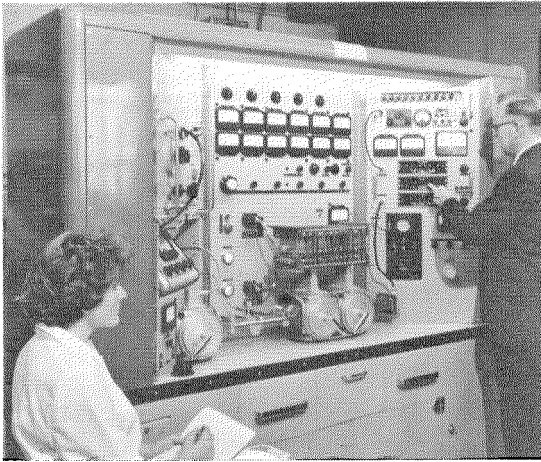

Figure 6—Microwave test console.

### 8. Resistors, Thermistors, and Varistors

Despite the apparent simplicity of the devices tested, the program of this test center is rather heavy. It includes investigations on test procedures and aging processes in addition to the routine testing work.

For example, investigations have been made of ways to detect manufacturing imperfections, such as nonhomogeneous carbon films or poor end connections to the caps and lead wires. Such defects are not revealed by usual test procedures and can result in catastrophic failures. They may be detected by an overload cycling test, each cycle consisting of 1 second of overload at 25 times rated dissipation followed by 29 seconds without load. This method is not applicable in all cases, however; it is too destructive and may only be used for low resistance values because of limiting voltage considerations. Alternative methods are therefore being developed.

The white noise produced by a resistor is another area for detailed examination. A correlation is yet to be found between the noise level under overload and the defects to be identified. A substantial advantage of the new method, if it proves successful, is that it is

quick and nondestructive, which makes it applicable for incoming inspection and production control.

The conclusions are generally derived statistically from fairly large samples, that is, by making and compiling a large number of measurements. Automation of the latter has become indispensable. A self-balancing bridge has been put in operation for resistance measurements; results may be punched on tapes or printed by an electric typewriter.

The distribution functions, mean values, standard deviations, et cetera, and correlation coefficients are determined by the computing center of Standard Elektrik Lorenz.

### 9. Connectors

Tests and measurements on connectors are particularly important in view of the necessity for interchangeability among different manufacturers' products and the degree of standardization that this requires.

The test facilities are not separate from the environmental and electrical testing laboratory at Bell Telephone Manufacturing Company. In fact, the ITT Europe test specification, prepared by specialists, emphasizes two tests: an accelerated humidity test of 7 days and a longer test of 150 days. The lots used represent 800 contact points for each test.

Of course, this is combined with other tests. Each lot is subdivided into 4 groups that are subjected to 0, 100, 500, and 1000 plug-in operations, respectively, before humidity tests commence, and equivalent mechanical operations are repeated at various times.

Individual contact resistance, insulation resistance, and breakdown voltage between adjacent contacts are measured as behavior criteria, and a visual inspection (with magnification) is made at the end of the whole series of experiments.

The local facilities are suitable for other investigations, such as mechanical, metallurgical, and

chemical causes of failure, silver migration on dielectric materials for printed-circuit boards, et cetera.

## 10. Conclusions

Only the centralized activities are described in this paper and these constitute a small part of the quality-control and assurance organization within ITT Europe. Each parts factory has its own services for quality control. Similarly, equipment manufacturing companies have inspection services for incoming parts. Laboratoire Central de Télécommunications and Standard Telecommunication Laboratories both conduct advanced studies related to reliability. Improved methods have been developed; also elaborate test specifications have been devised, which in many cases have been in advance of internationally accepted standards.

**Charles A. Meuleau** was born in Paris, France, in 1908. He graduated from the École Supérieure de Physique et Chimie and also received the License ès Sciences degree from the University of Paris in 1928.

From 1931 to 1938, he was in the chemical industry. Previously, from 1929 to 1931, and after 1938, he served in the International System at the Paris laboratories, now known as Laboratoire Central de Télécommunications. From 1950 to 1958, he was head of the semiconductor products department. He is now with the Technical Office of ITT Europe headquarters, where he performs a coordinating function related to components. He has worked on plastics, varnishes, natural and artificial piezoelectric crystals, thermistors, semiconductors, and electronic measurements of physical properties.

Mr. Meuleau collaborated with Professor Goudet in preparing the book "Les Semiconducteurs—Diodes, Transistors et autres Applications."

## 11. Acknowledgments

The material for this article was furnished by the heads of the various test centers, namely Mr. H. Heimgartner (power rectifiers), Mr. J. Simonet (relays), Mr. B. Derjavitch (capacitors, transistors and diodes, and microelectronic devices), Dr. C. Heck (magnetic materials and cores), Mr. G. Wall (vacuum tubes), Mr. K. Gueldenpfenning (resistors, thermistors, and varistors), and Mr. F. Leyssens (connectors). The author wishes to express his gratitude for their assistance.

## 12. Reference

1. C. A. Meuleau, "High-Reliability Testing and Assurance for Electronic Components," *Electrical Communication*, volume 38, number 3, pages 307-324; 1963.

# Speech Immunity of Push-Button Tone Signaling Systems Employing Tone Receivers with Guard Circuits

L. GASSER

E. GANITTA

Standard Elektrik Lorenz AG; Stuttgart, Germany

## 1. Introduction

In push-button signaling systems employing tones or voice frequencies, the signals for each digit are represented by one or more frequencies within the voice-frequency band. While a connection is being established, any noise in the transmission channel will reach the tone receiver and can imitate a calling signal, thus causing a wrong connection. This gives rise to the problem of guarding the tone receiver against interference by unwanted voice frequencies.

These unwanted frequencies, although they may constitute speech or music, interfere with the signal tone receivers and are considered to be noise in this paper. They enter the transmission channel through the microphone, which can be switched off conveniently while the push buttons are operated but remains a source of noise the rest of the time that a connection is being established.

This interference or noise is precluded if the microphone can be switched off or disabled for the full calling period; this could be done by adding a push button operated by the subscriber or by reversing the feed-current polarity in the switching plant. If either solution is inconvenient or impracticable, or if there is no criterion available for timing the pole reversals accurately, the tone receiver must be guarded against noise by other means. Two methods are feasible. The tone can be accompanied by a signal immune to noise, such as a modification of the feed current that switches the tone receiver into the operative state only while the push button is actuated; or the tone receiver can be designed to distinguish a calling signal from noise and to be made immune to the noise by guard circuits.

Systems with tone receivers guarded against speech require no transmission path besides the communication channel; they introduce no ad-

ditional requirements and offer greater freedom in application.

Therefore, this paper studies the measures for best design of a push-button calling system with guard circuits, plus the collateral question of how many signal imitations can be tolerated. Experiments with guarded equipment and the results obtained are also discussed.

## 2. Basic Considerations

To distinguish calling signals from noise, the structure of the noise will be considered to identify its main features.

In a system using receivers with guard circuits, a calling signal is obviously harder to imitate if more and more conditions must be met simultaneously by a signal before it is accepted as genuine. Such conditions can be:

- (A) Location of the tone within the voice-frequency band.
- (B) Number of frequencies making up one signal.
- (C) Ratio of tone frequencies to each other.
- (D) Effectiveness of the guard circuit (this depends on its bandwidth, band location, and guard factor\*).
- (E) Type of code used.
- (F) Sensitivity of tone receiver.
- (G) Bandwidth of tone receiver.
- (H) Time provided for signal identification.
- (I) Equality of signal frequency levels.

For optimum dimensioning of a guarded tone calling system, it is necessary to know the effect

---

\* Guard factor is the ratio of the signal voltage to that noise voltage just actuating the guard circuit. In logarithmic notation, the guard factor is  $\Delta\phi = \phi_{\text{signal}} - \phi_{\text{noise}}$ .

of each of the above parameters. An optimum system may be defined as a system with the lowest equipment cost in which the probability of wrong connections because of signal imitations is negligible compared with other causes, such as the calling of wrong numbers. This investigation is statistical and requires voluminous practical experiments.

2.1 SPEECH AND MUSIC

Since speech and music entering the microphone are the main sources of noise, their following properties are of interest.

- (A) Spectral energy density in the band from 300 to 3400 hertz.
- (B) Recurrence probability of discrete frequencies.
- (C) Appearance of 2-tone combinations.
- (D) Duration of discrete tones.

The 2-tone combinations are of particular interest because the finally adopted system uses two frequencies for each signal.

Figure 1 shows the acoustic energy density of speech and music as a function of frequency. It may be seen that both causes of noise show sharp declines at frequencies above 1000 hertz.

An investigation of the spectral distribution of speech tones reveals typical patterns of speech sounds that are generated by resonance phenomena in the human speech organs. These formant patterns [1] scarcely change their position in the voice-frequency band and have amplitudes independent of the pitch. They give each sound its characteristics and their position in the frequency band enables the human ear to distinguish among sounds.

The vowels are conspicuous among these sounds because of their almost strictly periodic nature, which permits them to be identified in the complex waveform of a syllable or a word [1-3]. Some of these periodic sounds are analyzed in Figure 2 [1]. Remarkably, the fundamental often has a lower amplitude than its harmonics.

The highest amplitude of any vowel is typically at a frequency lower than 1000 hertz. This confirms the characteristic trend in Figure 1;

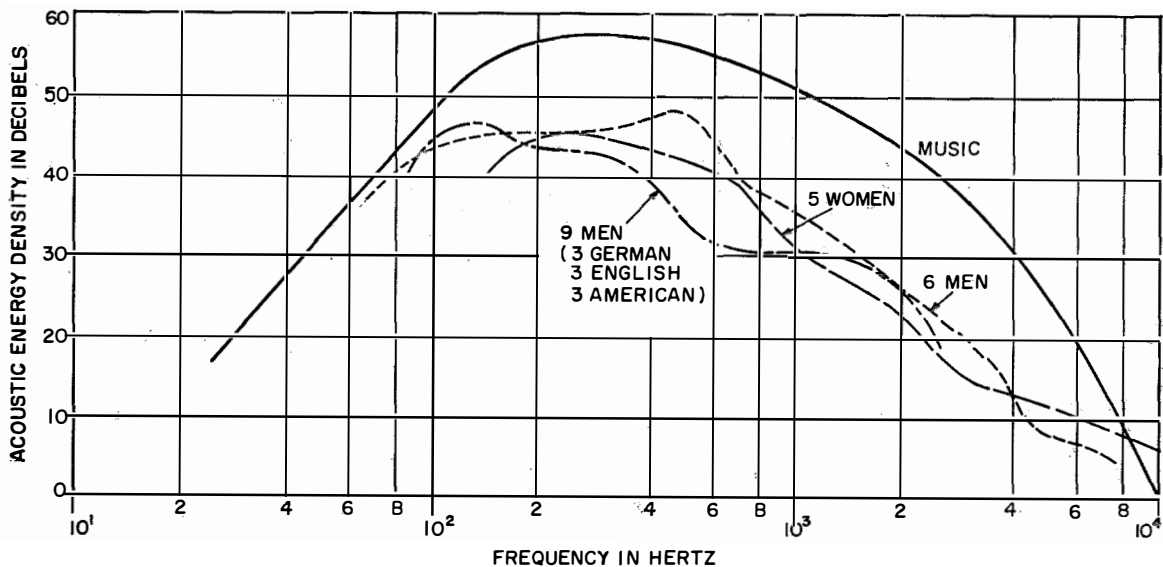

Figure 1—Mean value of spectral intensity for speech and music, referred to a 1-hertz bandwidth and a threshold of  $2 \times 10^{-5}$  neper per square meter (Dunn and White, 1944; F. H. Luder, 1930; Steinkogler, 1954).

## Speech Immunity of Tone Signaling Systems

the vowels contain the main share of speech energy.

Figure 2 also shows that 2-tone combinations can be generated by individual vowels when, for instance, two frequencies appear with high amplitudes while the other frequencies have relatively low amplitudes. The most-frequent combinations are 1:2, 2:3, 3:4, 3:5, 4:5, and 5:6. We may thus conclude that a vowel could imitate a call signal composed of two frequencies.

Moreover, roughly one third of all speech sounds are vowels in most languages. In this context, the consonants must be considered inasmuch as they are voiced and contribute one quarter of all speech sounds or even more, depending on the language. Their spectral distribution is similar to that of the vowels, although the energies are lower [1].

Similar relationships can be established in music. Most musical instruments generate a sound spectrum with strictly harmonic sound components [1, 4]. Figure 3 shows the recurrence among 3270 musical notes of their fundamental frequencies as percentages of the

total; the concentration between 350 and 750 hertz is unmistakable [5].

Again, the fundamental frequency of a musical tone does not always have the highest amplitude compared with its harmonics. Some musical instruments generate high amplitudes even at frequencies of several kilohertz. As in the case of vowels (Figure 2), two amplitudes may be particularly conspicuous in the range between 300 and 3400 hertz, depending on the instrument. Many musical instruments are characterized by their sound components being integer multiples of the fundamental pitch.

Musical selections feature a particularly frequent recurrence of double tones that are significant to this discussion. Figure 4 indicates the recurrence distribution of double-tone combinations; that is, the frequency ratios of two tones occurring simultaneously [5]. The octave frequency ratio 1:2 predominates. Note that six of the combinations recurring most often are the same as in speech and that in addition combination 5:8 must be considered.

The duration of discrete sounds is also of in-

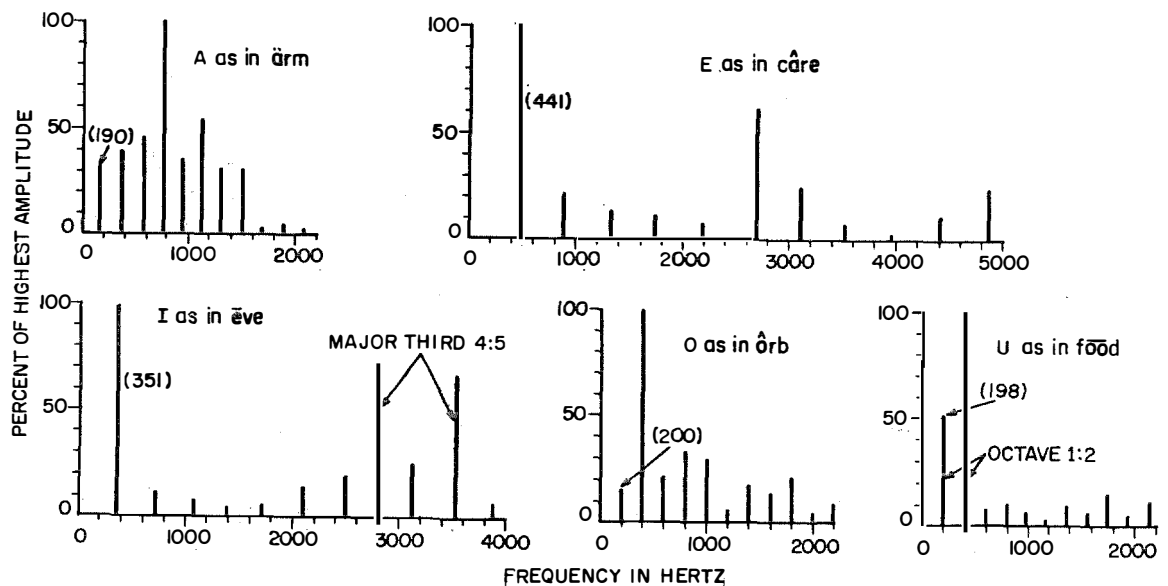

Figure 2—Frequency spectrum of 1 pronunciation of each vowel, shown as percentages of its highest-amplitude component [1]. The fundamental frequency in hertz is shown within parentheses on each graph.



terest. A vowel may last from 40 to 500 milliseconds [6].

The recurrence distribution of musical-tone durations may be seen from Figure 5 [5]. The mean duration of a musical tone is from 100 to 300 milliseconds, depending on the tempo. When music is played very fast, even a 1/64 note will last at least 20 milliseconds.

From these considerations, two important conclusions may be drawn for guarding the tone receivers in the signaling system.

(A) Because of the energy distribution, the signal frequencies should not be chosen from the lower and medium speech band unless required by collateral conditions.

(B) When choosing 2-frequency tones for signaling, those frequency ratios recurring most often in speech and music should be avoided.

2.2 EFFECT OF RECEIVER PARAMETERS ON IMMUNITY TO SPEECH

2.2.1 Location of Signal Tones in the Voice-Frequency Band

A comprehensive study by Flowers and Weir [7] revealed the need to consider carefully the fact that there is less sound energy in the upper part of the speech band. When speech-guarded tone receivers, operated at different frequencies

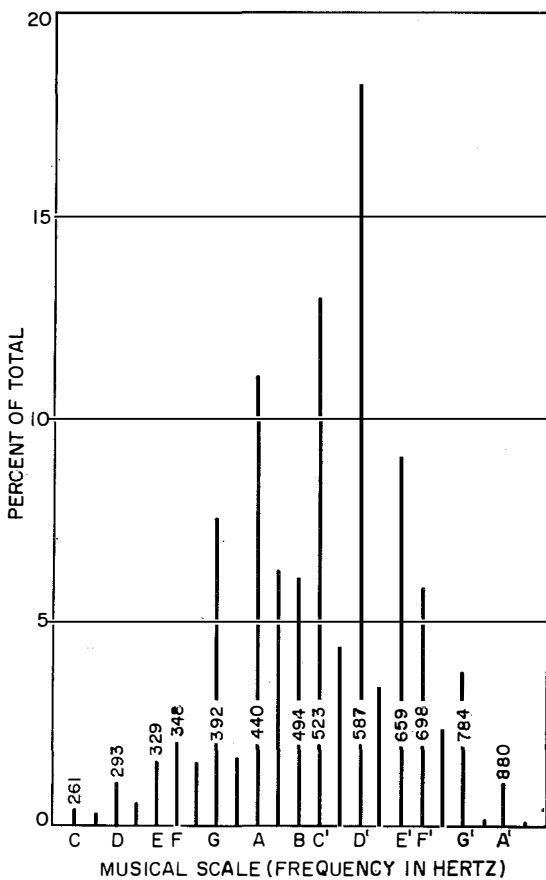

Figure 3—Percentage distribution of recurrences in music among 3270 pitch frequencies.

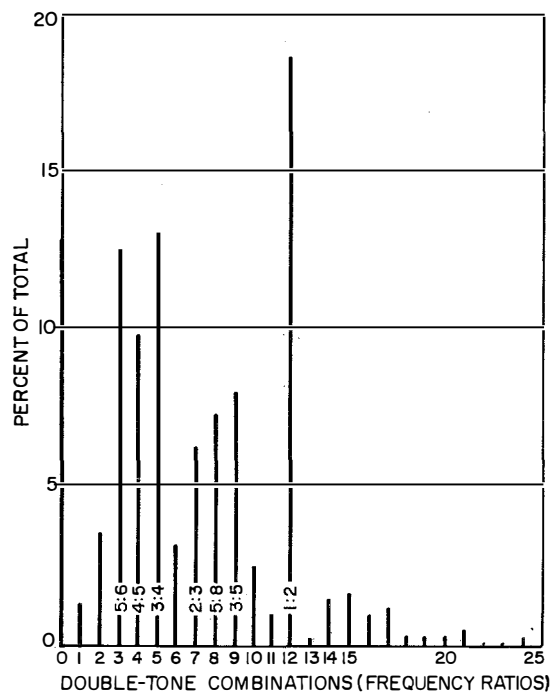

Figure 4—Percentage distribution of recurrences in music among 21 183 double-tone combinations.

- 0 = prime (1:1)
- 1 = minor second
- 2 = major second
- 3 = minor third (5:6)
- 4 = major third (4:5)
- 5 = fourth (3:4)
- 6 = diminished fifth
- 7 = fifth (2:3)
- 8 = minor sixth (5:8)
- 9 = major sixth (3:5)
- 10 = minor seventh
- 11 = major seventh
- 12 = octave (1:2)
- 13 = minor ninth
- 14 = major ninth

but having otherwise identical characteristics, were subjected to speech interference, the number of signal imitations decreased greatly for those receivers using frequencies in the upper speech band, as shown in Figure 6. This is in accordance with Figure 1.

Curves *A* in Figure 6 were derived by Flowers and Weir before 1950 from analysis of various languages transmitted via telephone lines, while curve *B* is the result of our measurements in telephone channels using more-modern transmitter capsules. All curves show peaks near 1000 hertz. This peaking at a higher frequency than shown by the curves of Figure 1 reflects the effect of the telephone channels. Our results agree remarkably well with those of Flowers and Weir as far as the general trend is concerned; the numbers of signal imitations in 100 hours of operation differ by one order of magnitude, however. Obviously this is explained by the different ratings of the receivers employed (refer to Table 1).

The response time of our receivers was only

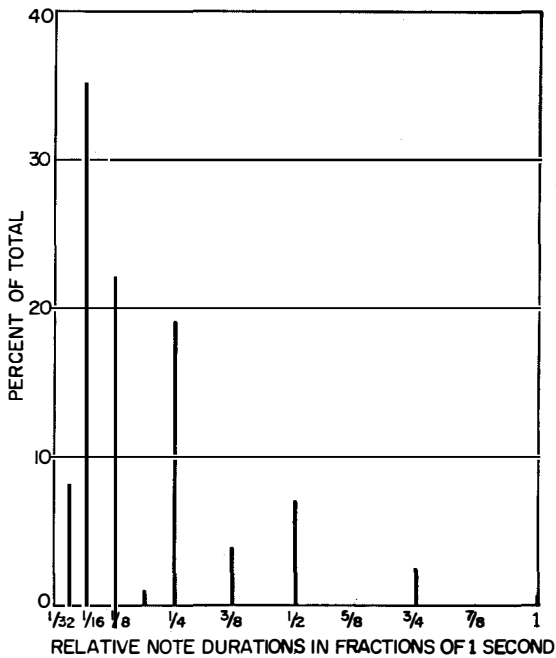

Figure 5—Recurrence distribution of the durations of 21 183 musical notes.

one-fifth that of the equipment used by Flowers and Weir, but the bandwidth was double. The effect of these two parameters will be discussed later. Considering the difference in receiver ratings, the results of both investigations are the same for all practical purposes. Other studies [8] tend to confirm the trend in Figure 6.

2.2.2 Number and Relative Location of Signal Frequencies

Obviously a single-frequency tone can be imitated much easier than a 2-frequency signal. Taking  $f_h$  for the higher and  $f_l$  for the lower

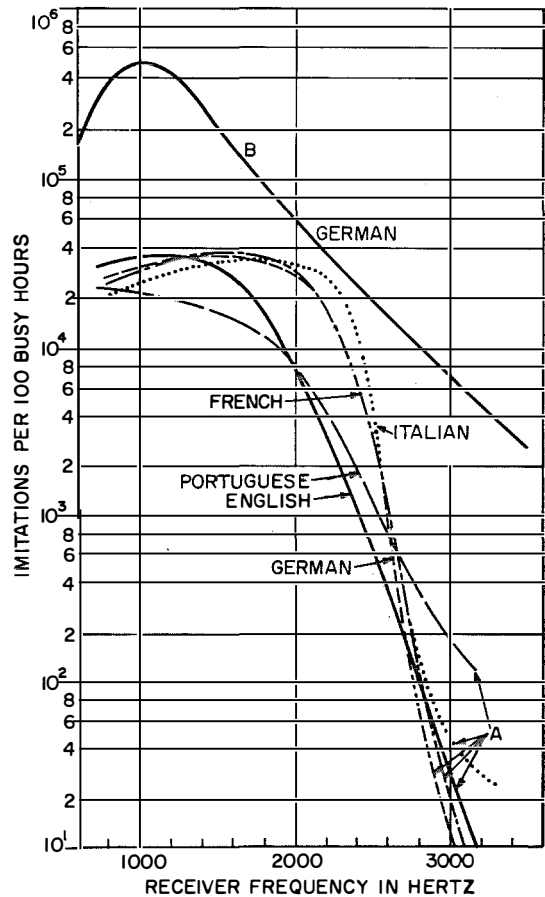

Figure 6—Occurrence of signal imitations as a function of the frequency of a single-tone receiver. Curves *A* were derived by Flowers and Weir [7] and curve *B* by the authors. Refer to Table 1.

frequency, this is clearly indicated in Figure 7, which measurements were obtained from tone receivers having no guard circuit. In addition, this diagram shows that the frequency combinations experimentally chosen for the signal tones avoided the troublesome combinations pointed out in the preceding section, with the general result that the number of imitations of 2-frequency call signals is substantially reduced.

### 2.2.3 Protection by Frequency Code

Although Figure 7 indicates that a signal should consist of several frequencies in combination, the equipment cost would be excessive if more than two frequencies were used. Hence we must select the most-practicable 2-frequency combinations. In anticipation of future developments that might require more than 10 signals, any 2-frequency code providing fewer than 10 combinations should not be used.

Such considerations point to either a 2-out-of-6 code, as discussed by European administrations for long-distance calls [9, 10], or a 2-group code suggested by L. Schenker [11]. The 2-group code offers an additional advantage for error detection: The signal is identified as genuine only if one frequency is detected in each of the two groups simultaneously. On the other hand, any two selected frequencies may form a genuine signal in the 2-out-of-6 system.

Development work has also shown the practicability of simple signal-amplitude monitoring in the 2-group system. This is another error-detecting feature that prevents false signals

from entering the receiver. A signal is taken as genuine if the amplitude difference between both of its frequencies does not exceed a given value. This feature approximately doubles the immunity to speech imitations.

The advantage of the 2-out-of-6 code is that it has already been favored in some countries. However, this advantage is almost negligible when carefully assessed. It is also possible to subdivide the 2-out-of-6 combinations into groups so that amplitude monitoring may be used for error detection as in the 2-group system; however, the equipment cost would then be increased considerably [12].

Our investigation showed the 2-group code to be superior to the 2-out-of-6 code inasmuch as it gives at least tenfold immunity to speech noise.

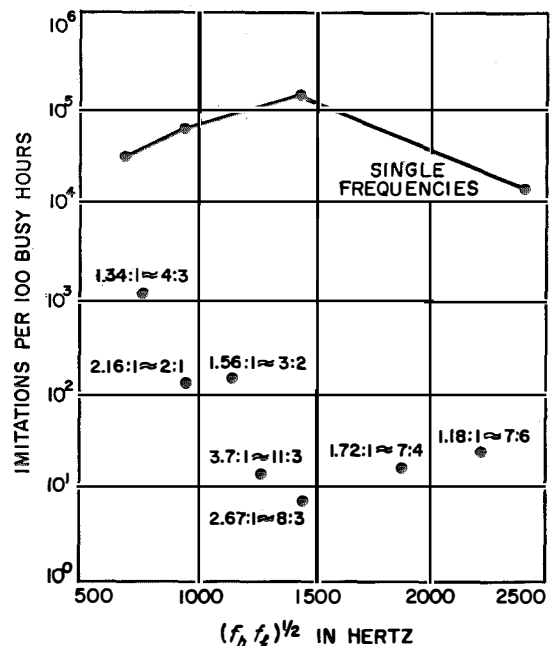

Figure 7—Comparison of protection afforded by single-frequency and 2-frequency tones. The indicated ratios represent  $f_h/f_g$ , and are plotted at their geometric means  $(f_h f_g)^{1/2}$  in hertz. Receiver ratings were: bandwidth, 150 hertz; sensitivity, -26 decibels referred to 1 milliwatt; and response time, 25 milliseconds. No speech-guard circuit was used.

Rating	Flowers and Weir [7]	Authors
Bandwidth in hertz at half-power points	100	200
Sensitivity in decibels referred to 1 milliwatt	-30	-20
Guard factor in decibels	6	9
Response time in milliseconds	50	10

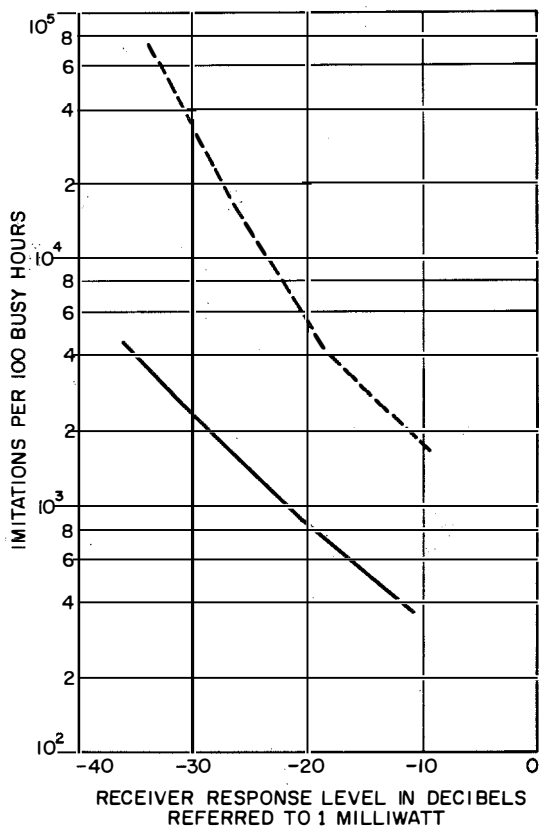

Figure 8—Number of signal imitations as a function of receiver sensitivity. The solid curve was derived by Flowers and Weir [7] and the broken curve by the authors. Refer to Table 2.

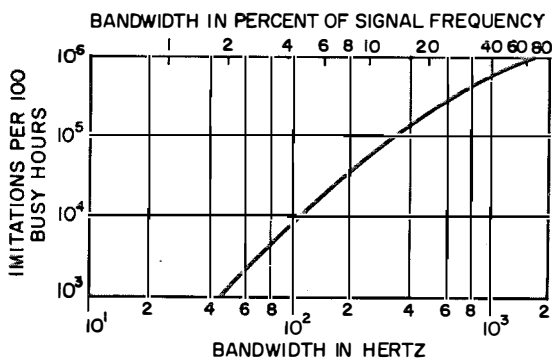

Figure 9—Number of signal imitations as a function of receiver bandwidth. Receiver ratings were: signal frequency, 2500 hertz; response time, 10 milliseconds; sensitivity, -22 decibels referred to 1 milliwatt; and guard factor, 9 decibels.

### 2.2.4 Receiver Sensitivity

As may be expected, the number of signal imitations increases with receiver sensitivity as shown in Figure 8 and Table 2. The receiver will then respond to a greater range of speech amplitudes. Hence the obvious remedy is to provide for the highest possible signal amplitudes so that the receiver sensitivity can be kept low. However, these amplitudes cannot be increased without limit because of crosstalk produced in adjacent channels. Tests have disclosed a permissible sum level of 0 decibels referred to 1 milliwatt, about equal to the level recommended for supervisory tones by the Comité Consultatif International Télégraphique et Téléphonique. Hence the tone-receiver sensitivity is determined by the transmit level and the maximum line attenuation.

### 2.2.5 Receiver Bandwidth

The number of imitations is related to the bandwidth as shown in Figure 9. In the range between 4 and 8 percent of the relative bandwidth, for instance, the signal imitations approximately triple. The relative bandwidth should be as narrow as possible in principle. However, the bandwidth directly affects the speed of signaling; for this reason, and because of the higher filter-network cost, it cannot be made as narrow as would be desirable. A bandwidth of 4 percent would meet the tone calling system requirements with respect to the buildup time; on the other hand, equipment should use the greatest allowable bandwidth for economy.

Rating	Flowers and Weir [7]	Authors
Frequency in hertz	2400	2400
Bandwidth in hertz at half-power points	100	150
Guard factor in decibels	4.5	No guard circuit
Response time in milliseconds	25	25

2.2.6 Guard Time for Noise Suppression

The analysis of speech and music indicated a median duration of about 250 milliseconds for most 2-tone combinations in speech and music. This raises the possibility of suppressing these combinations by requiring a longer time, say, 300 milliseconds for detecting and processing a signal in the receiver. As has been confirmed by our experiments and elsewhere [7, 13-15], this guard time would be necessary if it were the only means of protection. If the guard time is made longer than 300 milliseconds, the number of signal imitations rapidly decreases.

However, a guard time of this duration is quite unacceptable with respect to signaling speed. Investigations [16] have shown the median duration of push-button actuation to be 100 milliseconds; the shortest actuation of 30 milliseconds covers 0.05 percent of all cases. This duration of 30 milliseconds limits the maximum guard time.

Since it is impossible to use the optimum guard time for tone receivers, the necessary protection from interference by speech and music must be obtained with the aid of the other parameters. If the receivers have a response time of 10 to 20 milliseconds, the shortest push-button actuation of 30 milliseconds requires that the guard time not exceed 10 milliseconds. The efficacy of such a short guard time is shown in Figure 10. Measurements obtained from three receivers are in good agreement. A guard time of 10 milliseconds permits suppression of 80 percent of all signal imitations.

Rating	Curves A and B	Curve C
Bandwidth in hertz	100	150
Sensitivity in decibels referred to 1 milliwatt	-30	-27
Response time in milliseconds	20	50

2.2.7 Effectiveness of the Guard Circuit

The guard factor itself has a substantial effect on the number of signal imitations. This may be derived from Figure 11 and Table 3 without difficulty, although the other parameters investigated are included in this presentation. As the guard factor is increased, its effect on noise suppression increases, but at a lower rate. The protection gained when the guard factor is increased, say, from 10 to 20 decibels, is of little significance.

This information has an important bearing on guard-circuit dimensioning. If a high ratio or guard factor is chosen for best suppression of imitations, the guard circuit will respond to lower noise levels. As a result, line noise such as switching clicks or selector noise may block the tone receivers and prevent them from receiving the call signals. The choice of guard factor must therefore be based on a compromise that takes the expected line noise into account. In this respect Figure 11 gives a useful indication.

Calling signals also must be protected against the proceed-to-dial tone transmitted from the central office to the subscriber station as soon

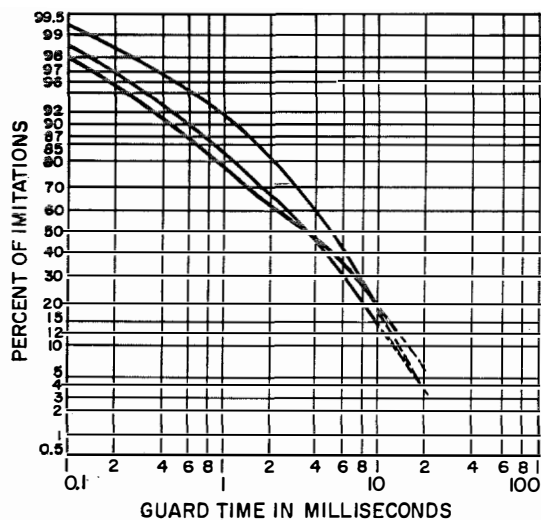

Figure 10—Percent of signal imitations that equal or exceed the corresponding guard times. The 3 curves are for 3 receivers.

as the handset is lifted. The proceed-to-dial tone chosen in many countries is based on recommendations of the Comité Consultatif International Télégraphique et Téléphonique of  $425 \pm 25$  hertz, with a level of the order of mean speech power level. Hence this would block the tone receivers.

Three remedies are feasible.

- (A) Reduce the level of proceed-to-dial tone,
- (B) Connect a 425-hertz band-stop filter to the tone-receiver input, or

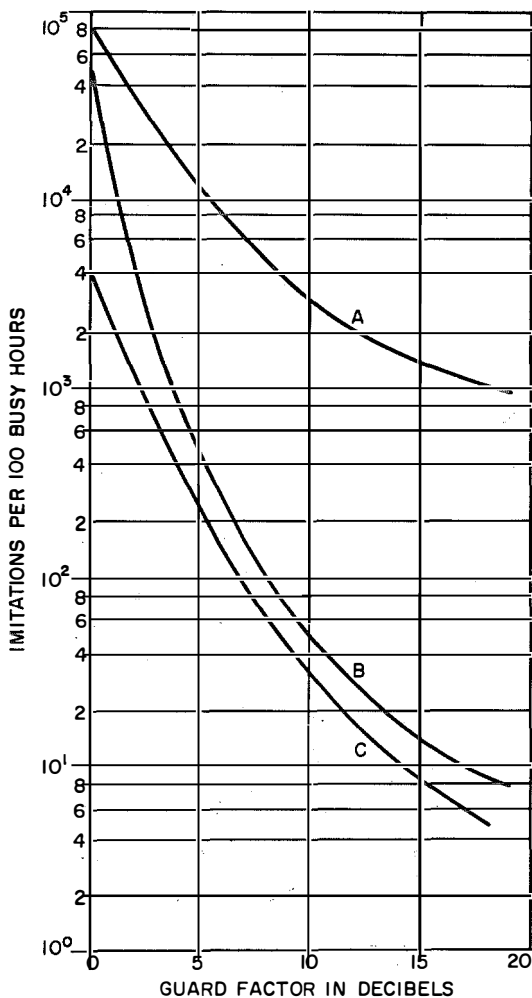

Figure 11—Effect of guard factor on signal imitations. Curve A is for 2400-hertz single frequency, curve B for two frequencies of 2000 and 2400 hertz, and curve C for 3000-hertz single frequency. Refer to Table 3.

(C) Using a hybrid in the central register, transmit the proceed-to-dial tone only in the direction of the calling subscriber.

Solution (C) is most expedient as the dial-tone level need not be changed and the speech immunity suffers no loss. Of course, all three solutions could be used in combination.

In switching systems that put through the calling subscriber line while the connection is being established, the tone receivers can be blocked to further calling signals by selector noise, other supervisory tones, or announcements. This disadvantage is eliminated by the hybrid, which provides a temporary speech path via the register and also decouples the tone receivers from the originating line. Of course a hybrid does not provide absolute decoupling, which is another reason why the guard factor should not be made too high.

#### 2.2.8 Summary of Parameters Influencing Speech Immunity

Table 4 lists the effectiveness of all parameters influencing speech immunity. The effectiveness factor should be understood as the ratio of the maximum-to-minimum numbers of imitations. Note that the first four parameters substantially determine the immunity of the system to signal imitations. The near-optimum solution is thus clear: a system using two signal frequencies; a guard factor of 10 decibels; locating both frequency groups in the upper part of the speech band; and using one frequency at a time from each of the two frequency groups.

A significant requirement is that no two frequencies making up a calling signal may form a combination that recurs often in speech and music.

This briefly summarized result served as a guiding principle in the experiments described in Section 4. However, it is first important to know the number of signal imitations tolerable from the standpoint of the grade of service.

**3. Tolerable Number of Signal Imitations**

The quality of telephone service is characterized by the behavior of both the subscribers and the switching equipment. As wrong connections can result from imitated signals in the push-button calling system, we should determine what number of lost calls are caused by the subscriber originating a wrong digit and what number by malfunctioning switching equipment.

Traffic studies by a European telephone-operating administration [17] revealed that wrong connections caused by subscriber dialing error amounted to 0.85 percent in toll traffic and 0.25 percent in tie-line toll traffic, referred to the total number of calls. Malfunctions of switching plant result in the respective figures of 0.40 and 0.20 percent [17-21]. Figures related to local traffic have not been published to date; it may be assumed that wrong connections in local traffic are even fewer because of the shorter subscriber numbers. However, Tell [22] has found that lost calls in local traffic are relatively higher because the subscribers are less attentive than in long-distance dialing.

Let us assume the subscriber does not make more mistakes in push-button signaling than in dialing. Let us further assume the known lesser values for short-haul traffic. We thus obtain a total of lost calls of  $0.25 + 0.20 = 0.45$  percent. The number of faulty operations caused by signal imitations should not exceed one tenth of this value to keep it from rising too high. This would correspond to 0.05 percent; that is, 5 out of 10 000 calls may be permitted to result in wrong connections because of signal imitations.

This value of 0.05 percent can be considered in terms of, say, 100 hours of occupancy of the central register. Assuming the register can handle each call in an average of 10 seconds, 36 000 calls would then be handled in 100 register busy hours with a tolerable total of about 20 signal imitations.

This grade-of-service specification for push-button signaling could be checked against exist-

TABLE 4 EFFECTIVENESS OF PARAMETERS INFLUENCING SPEECH IMMUNITY	
Parameter	Effectiveness Factor
2-frequency signaling compared with single-frequency signaling	20 to 2000*
Guard factor, from 0 to 10 decibels	200
Location of signal frequencies in the medium or upper portion of the voice-frequency band	100
2-group code compared with 2-out-of-6 code	10 to 50
Guard time, from 0 to 10 milliseconds	5
Receiver bandwidth, from 8 to 4 percent	3
5-decibel reduction in receiver sensitivity	2

\* Depending on the ratio of the two frequencies.

ing specifications for systems that have speech immunity. For voice-frequency signaling equipment based on specifications of the German Bundespost and the Comité Consultatif International Télégraphique et Téléphonique, tone receivers with guard circuits are also provided. The specifications for these receivers tolerate 3 and 10 signal imitations, respectively, in 100 busy hours. Here, however, the busy hour refers to the duration of conversation, as the tone receivers are permanently associated with the individual lines. A signal imitation can thus cause an existing connection to be released. Assuming a mean duration of 3 minutes for one conversation [19], 100 busy hours would be equivalent to 2000 conversations of which 3 (or 10) may be lost because of signal imitations. This is equivalent to 0.15 and 0.5 percent, respectively, which shows that the requirement derived earlier (0.05 percent) is substantially more stringent.

**4. Experiments with Tone Receivers**

To obtain reliable information about the speech immunity of various receiver designs, the investigation should be oriented to extreme conditions of actual operation. The evidence is even-

## Speech Immunity of Tone Signaling Systems

more persuasive if the experiments include conditions that are more stringent than in the worst case of actual operation.

### 4.1 METHOD OF INVESTIGATION

In the test setup shown in Figure 12, the tone receivers were tested with a broadcast program comprising 50 percent speech and 50 percent music. To preclude the influence of chance, the various receivers were tested in such a way that they received partly the same and partly different noise programs. No difference in results was detected.

The output of the broadcast receiver was first applied electrically to the tone receivers at a level of  $-10$  decibels referred to 1 milliwatt. The same output was recorded on the first track of a magnetic tape recorder. A counter was connected to the outputs of the tone receivers and counted the total number of signal imitations. Other counters having time-delay networks for 2, 5, and 10 milliseconds counted the imitations according to duration. When a signal imitation appeared across the tone-receiver output, this output pulse was used to mark the second track of the tape. This was done by trig-

gering two generators at the same time, one of 50 hertz for a duration of 1 second, and the other of 1000 hertz for a duration of 50 milliseconds.

In the fast rewind mode of the tape recorder, the 50-hertz marker provided for rapid detection of the point marked on the tape. In the slow forward mode, the 1000-hertz tone indicated the precise position of the point marked, plus any fast-recurring imitations. During evaluation, the marked sections of the tape were played back repeatedly for the corresponding tone receiver.

In the playback mode, a test set connected to each of the tone receivers indicated by lamps which one had responded. Thus it was possible to establish whether speech or music had caused an imitation, the duration of the imitation, and the frequencies involved. In this way, the tone receivers were subjected to speech or music for 100 hours or more. For convenient comparison, the results were determined on the basis of 100 hours.

This test method should be regarded as extremely stringent for several reasons. In actual

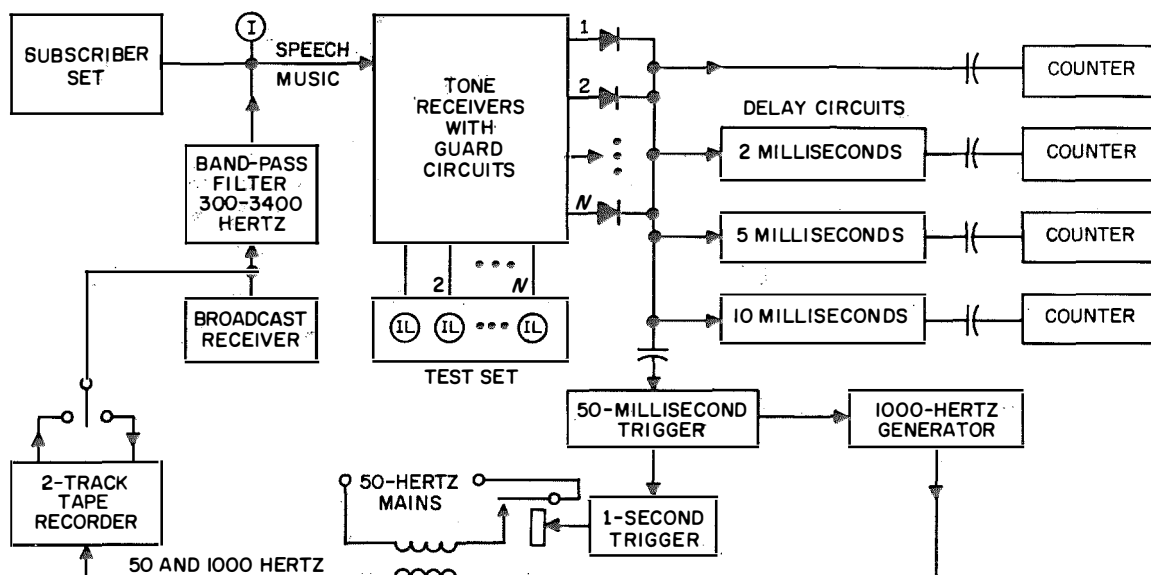

Figure 12—Diagram of test setup for measuring number of signal imitations as a function of duration.



operation, a register will rarely be loaded with speech and music for 100 successive hours. This suggests testing tone receivers in actual operation while they are connected to switching equipment. The statistical values then measured would reflect true operating conditions as seen by the register. However, the imitations recorded could be originated by only a few subscribers.

As far as the register is concerned, the grade of service would scarcely be impaired by the imitations, while the few subscribers calling under unfavorable ambient noise conditions might suffer an extremely high percentage of wrong connections. That is why the very-stringent test method appears not only justified but indispensable; it is based, so to speak, on the least-favored subscriber.

The electrical output from the broadcast receiver to the tone receivers at  $-10$  decibels referred to 1 milliwatt corresponds to a very-high level of noise at the subscriber-station output. An equivalent acoustic input to the microphone of the subscriber station would require a loudspeaker volume not tolerable in a room with a telephone in use.

A relevant experiment showed that acoustically introduced noise had the effect of reducing the number of signal imitations by nine tenths in the same receiver. For the purpose of this experiment, those sections of the tape that caused imitations in the electrical mode during 100 hours of operation were consolidated on a single tape. This tape was played back via a loudspeaker at the highest bearable volume, and the sound was picked up by the handset microphone 1 meter (3.28 feet) from the loudspeaker. Even when the microphone was moved as close as possible to the loudspeaker, not all imitations were reproduced despite tone-receiver sensitivity of  $-31$  decibels referred to 1 milliwatt.

These experiments indicate that the electrical input level employed of  $-10$  decibels referred to 1 milliwatt creates greater disturbances than would be encountered under the worst conditions in practice.

### 4.2 THE 2-GROUP CODE

The arrangement developed for the 2-group code is shown in Figure 13. Two groups of four frequencies each are provided; the signal is formed with two signal frequencies, one from each group. The arrangement shown was used in all experiments; the only changes were made in electrical parameters to determine which ones protected the system best.

The input of this arrangement was connected to the subscriber line. The signals and noise were processed by the band-stop filters, the group amplifiers, and the eight tone receivers.

A selective tone receiver is of very-simple design. It comprises only one resonant circuit that accepts tones corresponding to its resonant frequency and rejects all others. If two or more receivers in a group operate simultaneously, all outputs from that group of receivers will be blocked by an exclusive-OR gate from operating the succeeding equipment.

Each group of tone receivers is protected against signals intended for the other group by a band-stop filter. A calling signal consists of one tone in each of the two groups. If the two such tones differ greatly in level their outputs also will be blocked from the subsequent equipment.

The tone-receiver outputs are connected to a coincidence-test circuit (AND gate). As soon as it detects the simultaneous presence of one frequency in each group, it triggers a delay network that can be adjusted to the guard time desired. The coincidence-test circuit checks whether the two frequencies continue without interruption for the duration of the guard time. If this is the case, it triggers the decoder and only then does the decoded digit appear across the output of the equipment.

If the durations of imitations are to be investigated, the guard time is removed simply by adjusting the delay network to 0 milliseconds.

The following considerations apply to the choice of signal frequencies and their location in the voice-frequency band of 300 to 3400 hertz.

## Speech Immunity of Tone Signaling Systems

Section 2.1 states that certain frequency ratios must be avoided as they frequently recur in speech and music in the form of 2-tone combinations. When these undesired combinations are plotted within the telephone band, they may be presented graphically on a log-log scale. The frequencies associated with specific ratios then appear as parallel diagonal lines, inclined by 45 degrees if both coordinates have the same scale. If the signal frequency of the lower group is now linked with the abscissa and that of the upper group with the ordinate, the 2-frequency combination is expressed by a point in the system of coordinates. Since there are four frequencies for each of the two groups, there will be 16 points in all. These should be so positioned in the system of coordinates that they are as far away as possible from the diagonal lines representing the undesired combinations.

This can be achieved with relative ease by providing a uniform logarithmic spacing among the points; that is, by basing the frequency allocation on a geometric grid so that

$$f_2/f_1 = f_3/f_2 = f_4/f_3 = \text{constant.}$$

The points must be expanded into squares or windows [11] of equal size to allow for component tolerances insofar as they affect the frequencies. If the tolerances are small, the windows can be correspondingly reduced in size, thus minimizing the possibility of their being crossed by the straight diagonal lines of undesired ratios.

### 4.2.1 First Experimental Grid

A provisional experiment was undertaken with the window test procedure to confirm its useful-

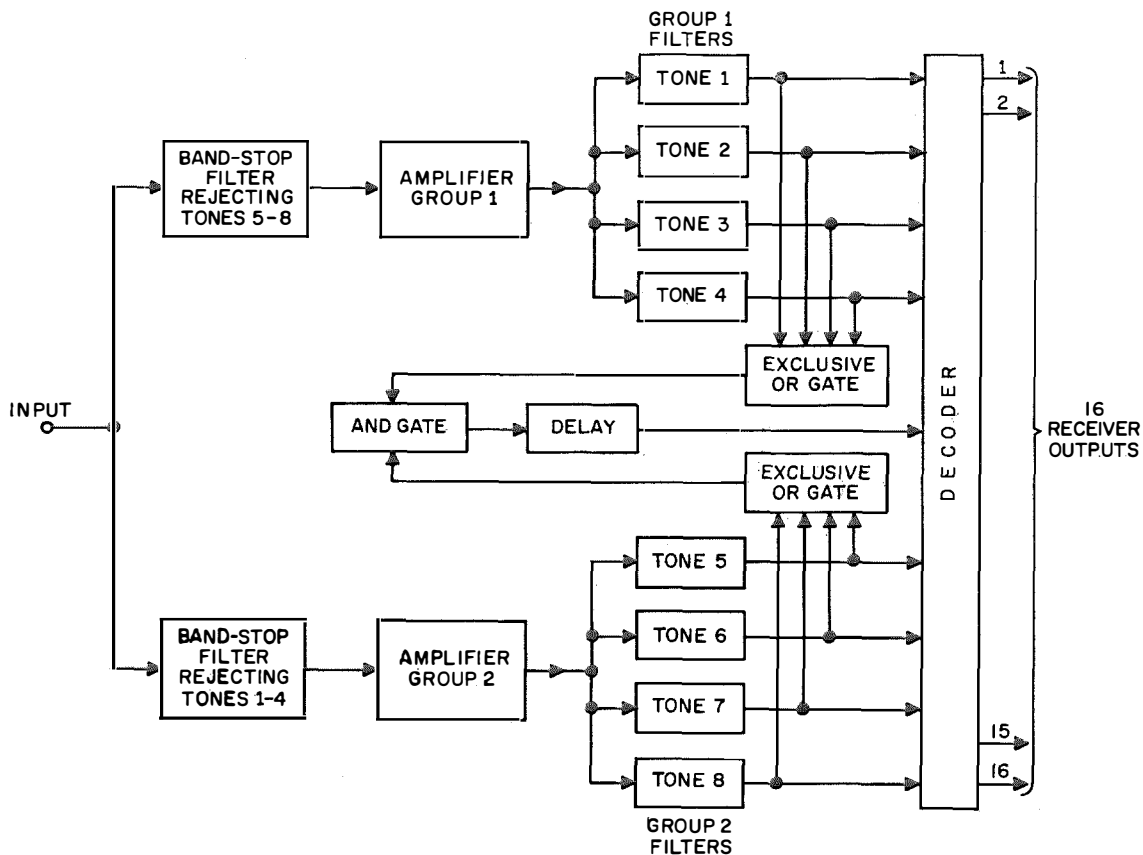

Figure 13—Arrangement of tone receivers for 2-group code.

## Speech Immunity of Tone Signaling Systems

ness and possibly to obtain basic information relating it to the push-button calling system. A frequency grid was selected in the medium range of the voice-frequency band in such a way that the windows were positioned between as well as on the straight lines of ratios. The window diagram is given in Figure 14. The tone receivers had the following ratings.

Bandwidth of each receiver in percent of nominal frequency	7
Sensitivity in decibels referred to 1 milliwatt	-31
Response time in milliseconds	15
Guard factor in decibels	11
Frequencies of first group in hertz	920, 1040, 1160, and 1280
Frequencies of second group in hertz	1520, 1700, and 1880

In this experiment, only 7 signal frequencies were used, providing for 12 combinations of two frequencies. The equipment was subjected continuously to speech and music for 206 hours. The results showed that windows not crossed by the diagonal lines were free of imitations.

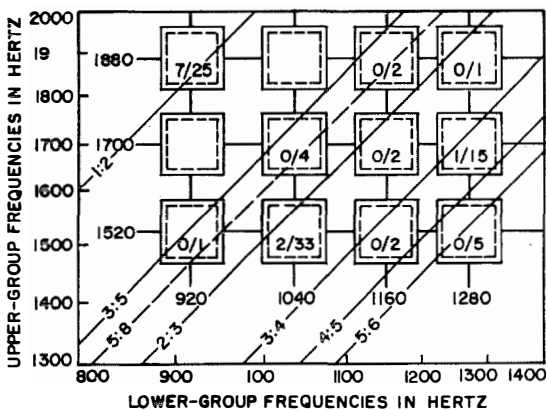

Figure 14—Window diagram of the provisional experimental grid. Solid-line windows provide for all circuit tolerances and are 7 percent ( $\pm 3.5$  percent) of nominal frequency. The broken-line squares are the actual signaling bandwidths and are 4.4 percent ( $\pm 2.2$  percent) of nominal frequency. The figures in the windows indicate percentages of the total number of imitations caused by speech/music. Ratio 5:8 is shown as a diagonal broken line because it is significant only for music, while speech is the primary consideration here.

The percentages of imitations that occurred were noted in the windows separately for speech/music. These percentages are listed in Table 5.

Ratio	Speech	Music	Total
1:2	7	25	32
2:3	2	36	38
3:4	1	17	18
3:5	—	5	5
5:8	—	2	2
4:5	—	3	3
5:6	—	2	2
	10	90	100

The 5:8 ratio has statistical significance only in music. Since speech is our primary consideration from now on, this ratio is shown as a diagonal broken line in the window diagrams to denote its relative insignificance.

The breakdown of imitations by ratios is very useful. Since it is difficult in some cases to allocate the frequencies so that no window is crossed by a diagonal line, this presentation permits the windows to be placed where they will be crossed by the diagonal lines of ratios that cause the fewest imitations.

Only about 10 percent of all imitations recorded were caused by speech. When the durations of imitations were evaluated, it was found (upper curve of Figure 10) that they were distributed as follows:

- 80 percent greater than 2 milliseconds
- 60 percent greater than 5 milliseconds
- 20 percent greater than 10 milliseconds.

Thus 80 percent of imitations would be suppressed if a guard time of 10 milliseconds is provided for each tone receiver.

To check the reliability of these results, they were statistically evaluated with respect to the

## Speech Immunity of Tone Signaling Systems

duration periods. This was done for all experiments. In the provisional experiment, a confidence range of  $\pm 35$  percent was established for the true statistical mean with a reliability of 90 percent.

The total number of imitations in 100 register busy hours was not much different from the value of 0.05 percent assessed as tolerable earlier. This relatively satisfactory result was

achieved partly by the high guard factor of 11 decibels and partly by the fact that the spectrum for speech and music was not limited to the telephone channel range of 300 to 3400 hertz; thus frequencies outside this range were capable of contributing to the receiver blocking. However, as explained earlier, it is inexpedient to base the speech immunity primarily on a high guard factor.

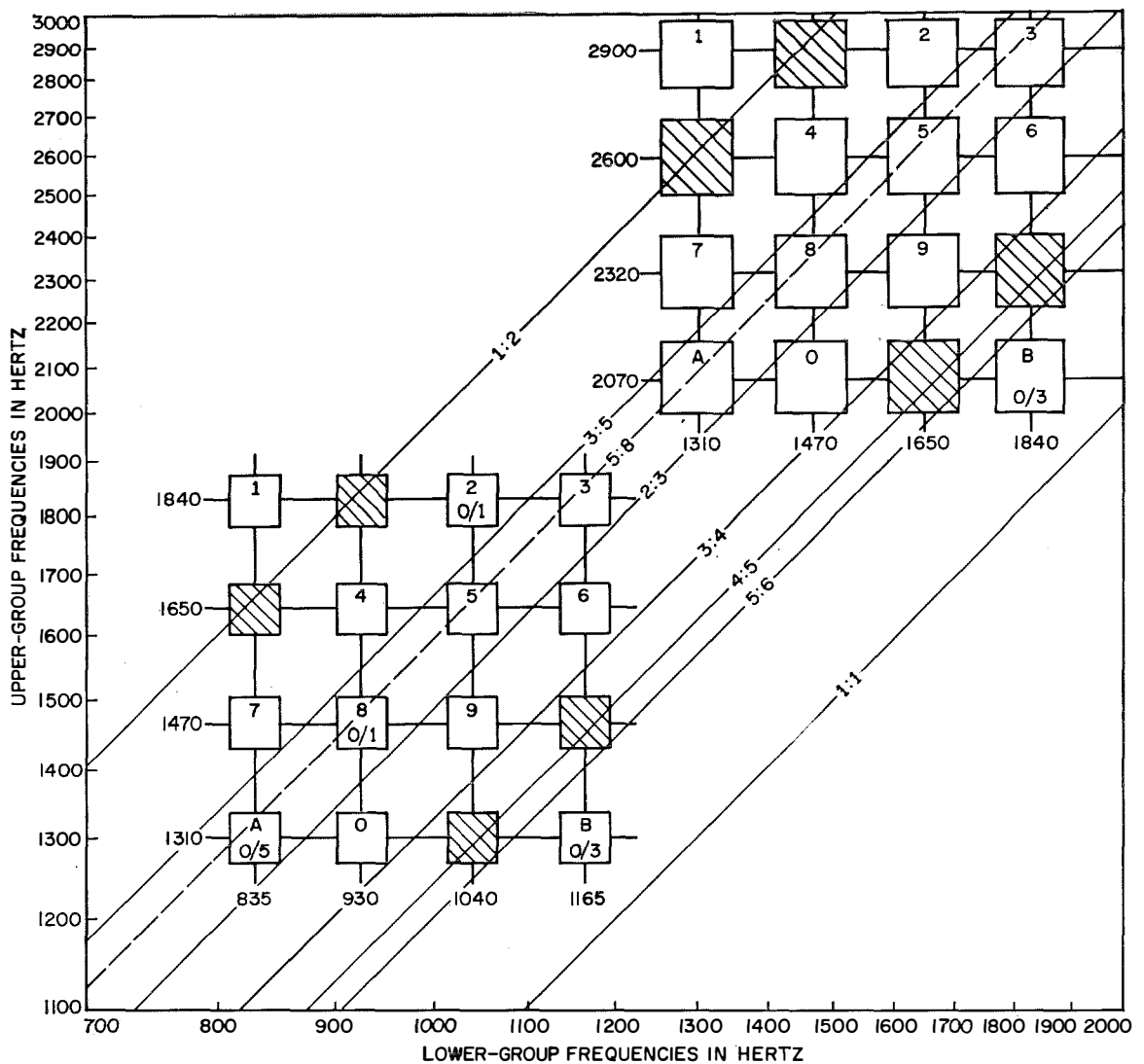

Figure 15—Window diagrams of optimum grid. Only the maximum bandwidths of the windows are shown. With a guard time of 10 milliseconds, the figures for imitations during 100 register busy hours by speech/music, respectively, are shown in the windows. The shaded windows are unsuitable for signaling. Refer to Table 6.

4.2.2. Optimum Grid for 12 Combinations

The results of the first experiment suggested a search for an optimum grid. While retaining the specified speech immunity, this grid should permit us to design the push-button calling system with the following characteristics.

(A) The bandwidth of the receivers should be as broad as possible for the most-economical dimensioning of the equipment, especially the tone generators in the subscriber stations. In our studies, it was found that a bandwidth of 7 percent met these requirements.

(B) A guard time of 10 milliseconds should be satisfactory considering the shortest push-button actuation of 30 milliseconds.

(C) Because of line noise, a guard factor of less than 10 decibels should be permissible.

The test results and receiver ratings for the upper voice-frequency range are listed in Table 6. The frequencies chosen and the bandwidth of 7 percent result in the window diagram shown in the upper portion of Figure 15.

Omitting the four shaded windows directly crossed by ratio lines, the remaining 12 are almost-perfectly placed between the ratio lines. This would be sufficient to form the 10 digits for calling and two additional signals. Only 3 imitations exceeding the guard time of 10 milliseconds were recorded, all caused by music.

Two arguments are raised occasionally against the use of signal frequencies from the upper voice-frequency range. If push buttons are actuated during a conversation, tone receivers of a long-distance network using signal frequencies

TABLE 6  
DATA FOR OPTIMUM WINDOW GRIDS OF FIGURE 15

	Upper Voice-Frequency Range				Medium Voice-Frequency Range			
	Guard Time in Milliseconds							
	0	2	5	10	0	2	5	10
Imitations per 100 register busy hours:*								
Speech	—	—	—	—	55	6	2	—
Music	5	5	4	3	204	60	22	10
Number of disturbed calls per 10 000 with guard time of 10 milliseconds	0.84				2.8			
Confidence range of measurements in percent with reliability of 90 percent	+130 -100				±85			
Duration of test in hours	100				156			
Receiver ratings:								
Maximum bandwidth (including tolerances) in percent	7				5			
Sensitivity in decibels referred to 1 milliwatt	-31				-28			
Response time in milliseconds	<15				<15			
Guard factor in decibels	7				6			
Level comparison	Yes				Yes			
Band-pass filter (Figure 12)	No				Yes			
Frequencies in hertz:†								
Group 1	1310, 1470, 1650, and 1840				835, 930, 1040, and 1165			
Group 2	2070, 2320, 2600, and 2900				1310, 1470, 1650, and 1840			

\* Tolerable number of imitations = 20.

† Frequency spacing = 11.8 percent; group spacing = 12.5 percent of highest frequency in group 1.

in this range could be caused to malfunction. It may be assumed that these discrete frequencies will not be used for push-button signaling. Thus they could conceivably be generated only by simultaneous actuation of several push buttons.

Even if improper use of the push-button stations could cause trouble, there are technical means to prevent the transmission of such frequencies. This argument is therefore unsound. The other argument refers to the use of loaded lines in the local network. Although the cutoff frequency of modern loaded lines is outside the voice-frequency band (5000 hertz in some cases), the upper voice-frequency band could be affected in older networks. This argument cannot be taken lightly; in a local network, trunks having a low cutoff frequency may indeed be encountered. For this reason, the next experiment consisted of shifting the signal frequencies to the medium range of the voice-frequency band without changing the frequency ratios. The test results and receiver ratings for the medium voice-frequency range are also given in Table 6.

Since these frequencies reached into the range of stronger sound energies, the bandwidth was narrowed to 5 percent. Thus the windows were reduced in size so that none was crossed by a ratio line. This is shown in the lower portion of Figure 15.

The investigation this time was somewhat more stringent because the noise band was restricted to the range from 300 to 3400 hertz. Despite the reduced bandwidth, the imitations had substantially increased. On the other hand, it is remarkable that they had only trebled for the guard time of 10 milliseconds. Even if the statistical uncertainty is considered, speech immunity remains within tolerable limits for this guard time.

Two details of these investigations are worth mentioning. The numbers in the windows of the lower portion of Figure 15 show a high percentage of imitations caused by ratio 5:8, which had been declared harmless. The fact is

that this ratio line almost bisects the windows while all other windows are barely touched by the other ratio lines. Thus the imitations caused by the 5:8 ratio appear to be relatively numerous because the total of all imitations is very low indeed. Also, the lower right windows of both window diagrams in Figure 15 showed imitations that were unexpected considering the positions of these two windows with relation to ratio lines. A completely different effect was involved here; these imitations had been caused by interfering frequencies between both groups of signal frequencies. If these interfering frequencies have high amplitudes, receivers that use the adjacent frequencies between the two groups may be caused to respond under certain conditions. From this, it may be concluded that the spacing between frequency groups (only 12.5 percent in Table 6) should be made as wide as possible.

### 4.2.3 *American Telephone and Telegraph Company Grid*

The grid chosen by the American Telephone and Telegraph Company [1, 23, 24] provides all 16 frequency combinations. The frequencies are positioned relatively low in the voice-frequency band. This apparently has been arranged with the intention of reserving space for another frequency group in the vacant upper band, thus permitting push-button calling for simple data transmission.

From our previous studies and from the results with the optimum grid (Figure 15), we may conclude that the Bell System grid would not provide equivalent speech immunity because its frequencies are positioned in the range of stronger speech energies. However, three series of experiments using these frequencies were performed to obtain additional information.

The window diagram for this lower voice-frequency range is shown in the lower portion of Figure 16. The test results and receiver ratings for this range are listed in columns 1 through 3 of Table 7. Comparison of columns 1 and 3 shows that the number of imitations

is approximately the same when either a broad bandwidth and high guard factor or a narrow bandwidth and low guard factor are combined. The important consideration is not so much the bandwidth, but rather the resulting crossings of windows by ratio lines. The same two columns should also be evaluated realizing that level comparison and absence of noise-band

limitation are two features that tend to reduce the number of imitations. This is clearly confirmed by column 2, where the number of imitations is particularly high because of the low guard factor, limitation of the noise band to the range from 300 to 3400 hertz, and absence of level comparison. These imitations are mostly of short duration, however; when the guard

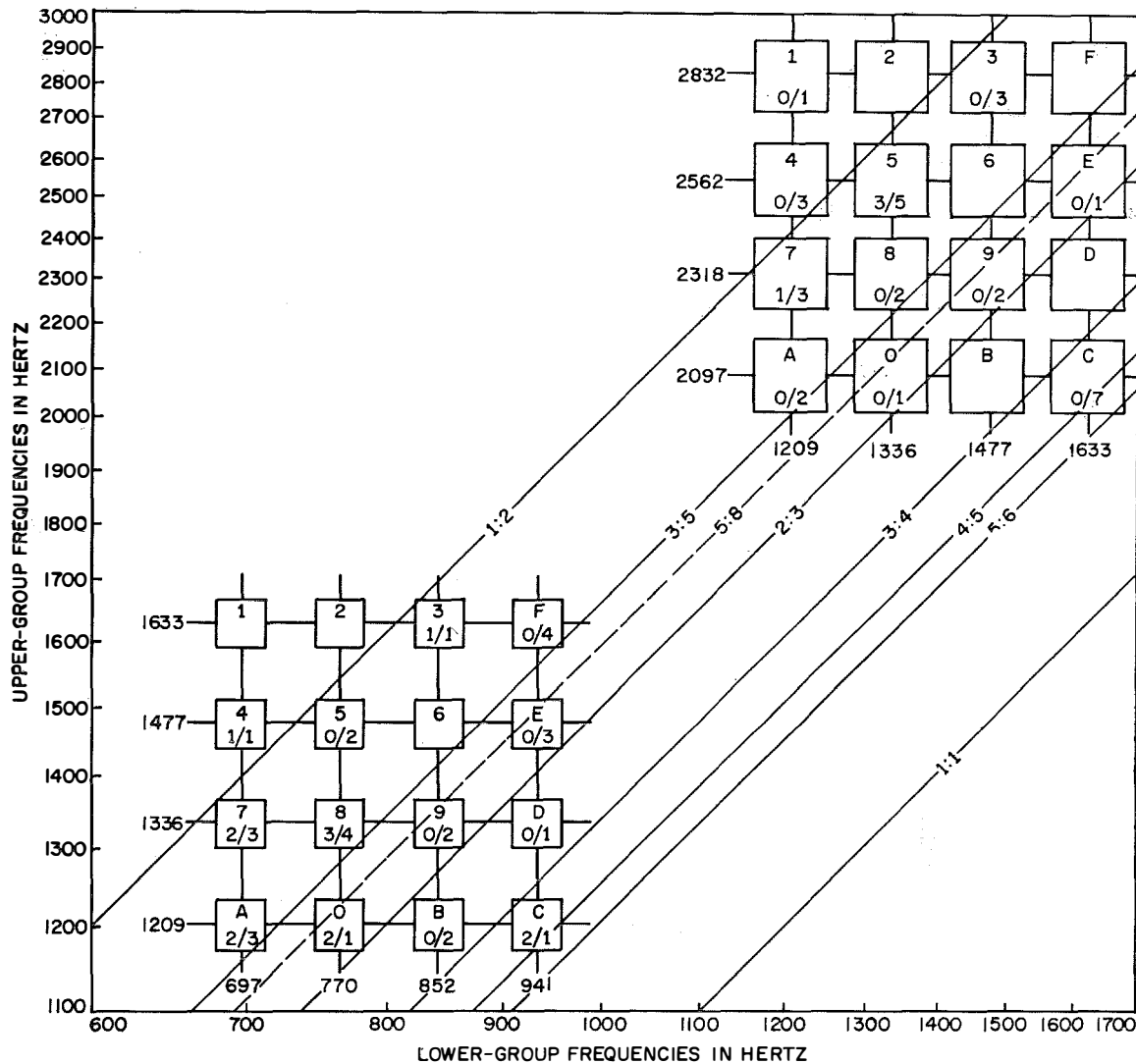

Figure 16—Window diagrams of Bell System grid. Only the maximum bandwidths of the windows are shown. With a guard time of 10 milliseconds, the figures for imitations during 100 register busy hours by speech/music, respectively, are shown in the windows. Refer to Table 7.

## Speech Immunity of Tone Signaling Systems

time in column 2 was 10 milliseconds, the number of imitations decreased to the order of magnitude of the other two columns.

Comparing these results with those from the optimum grid shows that the latter is superior by a factor of 20. However, the tolerance requirements of Section 3 can also be met by the Bell System grid if the guard time is increased to 20 milliseconds, which should be based in turn on a minimum push-button actuation of 40

milliseconds instead of the 30 milliseconds stated in Section 2.2.6. This increase may or may not be tolerable; a satisfactory answer probably will not be available until considerable experience is accumulated with a large number of subscribers.

The excellent speech immunity of the Bell System grid results from either a high guard factor or a narrow bandwidth. There is a way to minimize their effect and still offer as good or

TABLE 7  
DATA FOR BELL SYSTEM WINDOW GRIDS OF FIGURE 16

	Lower Voice-Frequency Range			Upper Voice-Frequency Range																
	1	2	3	4																
	Guard Time in Milliseconds																			
	0	2	5	10	20	0	2	5	10	20	0	2	5	10	20	0	2	5	10	20
Imitations per 100 register busy hours:*	168	103	53	13	2	444	158	32	10	1	93	44	17	13	2	25	10	5	4	—
Speech	458	182	97	56	9	2376	1002	168	70	14	385	218	95	35	7	160	98	43	27	5
Music																				
Number of disturbed calls per 10 000 for the following guard times:																				
10 milliseconds		16					20					10								7
20 milliseconds		3					4					2								1.5
Confidence range of measurements in percent with reliability of 90 percent		±25					±30					±42								±55
Duration of test in hours		110					154					115								115
Receiver ratings:																				
Maximum bandwidth (including tolerances) in percent		7					5					5								7
Sensitivity in decibels referred to 1 milliwatt		-31					-28					-31								-31
Response time in milliseconds		<15					<15					<15								<15
Guard factor in decibels		11					5					6								6
Level comparison		No					No					Yes								Yes
Band-pass filter (Figure 12)		No					Yes					Yes								Yes
Frequencies in hertz:†																				
Group 1							697, 770, 852, and 941													1209, 1336, 1477, and 1633
Group 2							1209, 1336, 1477, and 1633													2097, 2318, 2562, and 2832

\* Tolerable number of imitations = 20.

† Frequency spacing = 10.5 percent; group spacing = 28.5 percent of highest frequency in group 1.



better protection; namely, the grid could be shifted to higher frequencies. This was done without changing the frequency ratios. The grid for the upper voice-frequency range is shown in the upper portion of Figure 16. The test results and receiver ratings for this range are listed in column 4 of Table 7. Note that the objective of 20 imitations or fewer has been reached despite a low guard factor and a broad bandwidth.

4.3 THE 2-OUT-OF-6 CODE

The 2-out-of-6 code was mentioned as an alternative in Section 2.2.3, considering primarily the long-distance multifrequency coding of call signals [9, 10]. In this system, 6 frequencies within the medium voice-frequency range are used for one direction and 6 frequencies within the upper range are used for the opposite direction. In the following discussion, only the 6 upper frequencies are considered: 1380, 1500, 1620, 1740, 1860, and 1980 hertz. However, there is an essential difference between the 2-out-of-6 and the 2-group multifrequency signaling. While the 2-out-of-6 combinations are now used on long-distance lines, these lines are disconnected from the calling subscriber during switching. Therefore, any effect of speech on the selective tone receivers is precluded and the receivers neither need nor have guard circuits. The signal frequencies were therefore chosen on the basis of quite-different considerations. This is clearly seen in Figure 17 where we attempt to accommodate the 2-out-of-6-code frequencies, with their specified constant bandwidths of 60 hertz, in a window diagram.

To measure the speech immunity of this code, the same investigation that had been applied to the 2-group system was repeated with the aid of 6 receivers developed for the 2-out-of-6 system. These receivers had a common control by which the sensitivity was always adjusted to the highest level of a signal frequency. A code-checking unit connected to the receiver output ignored combinations of adjacent frequencies; this was necessary because the re-

ceivers had relatively flat filter characteristics. High-amplitude noise appearing between the frequencies of two adjacent filters could imitate signals in both receivers. However, such imitations are not within the scope of our investigation.

A guard circuit was provided in the form of an additional receiver having a 700-hertz bandwidth between 300 and 1000 hertz. When this receiver responded, it blocked the output of the code-checking unit.

The numbers of recorded imitations are shown in the windows of Figure 17. Test results and receiver ratings for the 2-out-of-6 experiment are listed in Table 8. Speech and music had imitated 262 and 753 signals, respectively. Speech thus produced 25 percent of the imitations compared with 10 to 20 percent in the previously described investigations. The number of imitations is about 20 times larger than in the 2-group system, and they are mainly in the windows associated with lower frequencies. On the whole, this experiment confirmed the principles put forth in Section 2.2 for the development of a push-button signaling system.

TABLE 8 DATA FOR 2-OUT-OF-6 WINDOW GRID OF FIGURE 17	
Imitations per 100 register busy hours:	
Speech	262
Music	753
Receiver ratings:	
Bandwidth in hertz	60
Sensitivity in decibels referred to 1 milliwatt	-34
Response time in milliseconds	15
Guard factor in decibels	11
Guard time in milliseconds	10
Band-pass filter (Figure 12)	No

4.4 COMPARISON OF GUARDED RECEIVERS

When the number of tolerable imitations for push-button signaling was assessed in Section 3, specifications for existing tone receivers with guard circuits were used for comparison. Therefore, it appeared useful to extend our investigations to these receivers. For this purpose, a

## Speech Immunity of Tone Signaling Systems

3000-hertz receiver of the type used in a European subscriber toll-dialing system, a 2040-hertz receiver, and a 1700-hertz receiver from other networks were tested. The test results and receiver ratings are given in Table 9. Although some receiver parameters differed, we confirmed that the number of imitations decreases with increasing signal frequency. All receivers had a relatively long guard time.

The total number of imitations in the 3000-hertz receiver is about 10 times larger than in the specification of the competent telephone administration. This is probably caused by the very-stringent test conditions introduced by music. Here the imitations were not broken down by speech and music; considering the relation found in the preceding experiments, however, the number of imitations caused by speech may meet the specification.

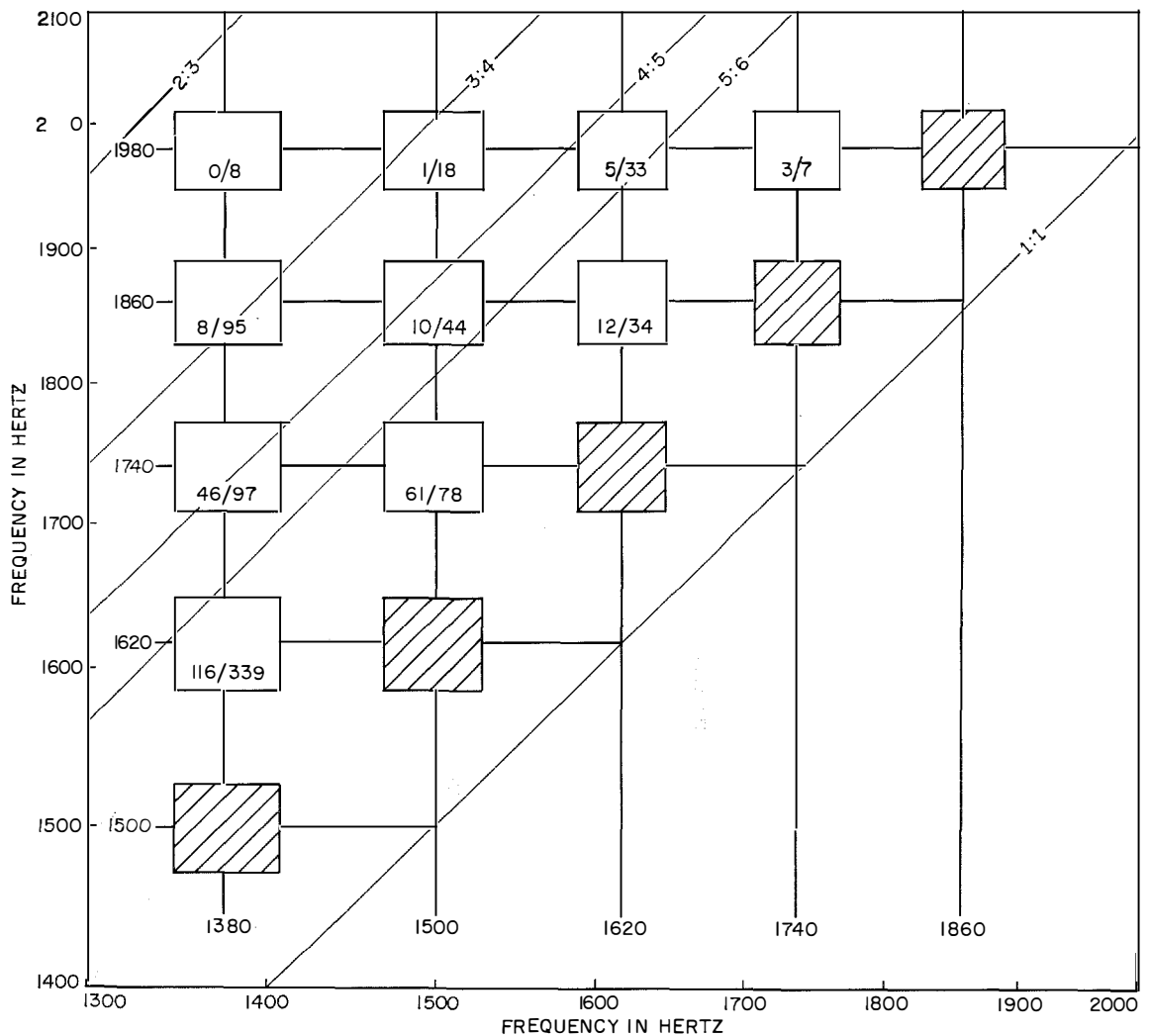

Figure 17—Window diagram for the 2-out-of-6 code. The figures for imitations during 100 register busy hours by speech/music, respectively, are shown in the windows. The shaded windows each employ two adjacent frequencies and were not evaluated because they were susceptible to imitations from single-frequency disturbances between their frequencies. Refer to Table 8.

Figure 18 summarizes the results given in Tables 6 through 9.

**5. Conclusions**

The investigations have shown the possibility of achieving a very-high degree of immunity to signal imitations by speech in a system that employs receivers with guard circuits, provided that the system is based on a 2-group code and that the effects of some essential parameters are duly considered.

The 2-out-of-6 code may be disqualified by the specification that not more than 5 out of 10 000 telephone connections (referred to the individual subscriber, not to the register) may be disturbed by imitations. All varieties of the 2-group system investigated meet this specification approximately, the optimum grid having a considerable safety margin.

The results obtained with Bell System grids show good mutual agreement and demonstrate that equivalent results can be achieved by exchanging parameters. Thus, the effect of signal imitations from combination tones on receivers having broad bandwidth can be compensated

for with a high guard factor or by shifting the signal frequencies into the upper voice-frequency range.

If it is felt that the four unused combinations in the optimum grid are indispensable, the Bell System grid with frequencies shifted into the upper range may be preferable because it meets the specifications best. This modified grid, compared with the original Bell System grid, gives

	Filter Frequency in Hertz		
	3000	2040	1700
Imitations per 100 register busy hours:	34	405	3150
Receiver ratings:			
Bandwidth in percent	4	7	8.5
Sensitivity in decibels referred to 1 milliwatt	-23	-27	-26

\* Each receiver had a response time of 15 milliseconds, guard factor of 11 decibels, and guard time of 50 milliseconds. No band-pass filter (300-3400 hertz) was used.

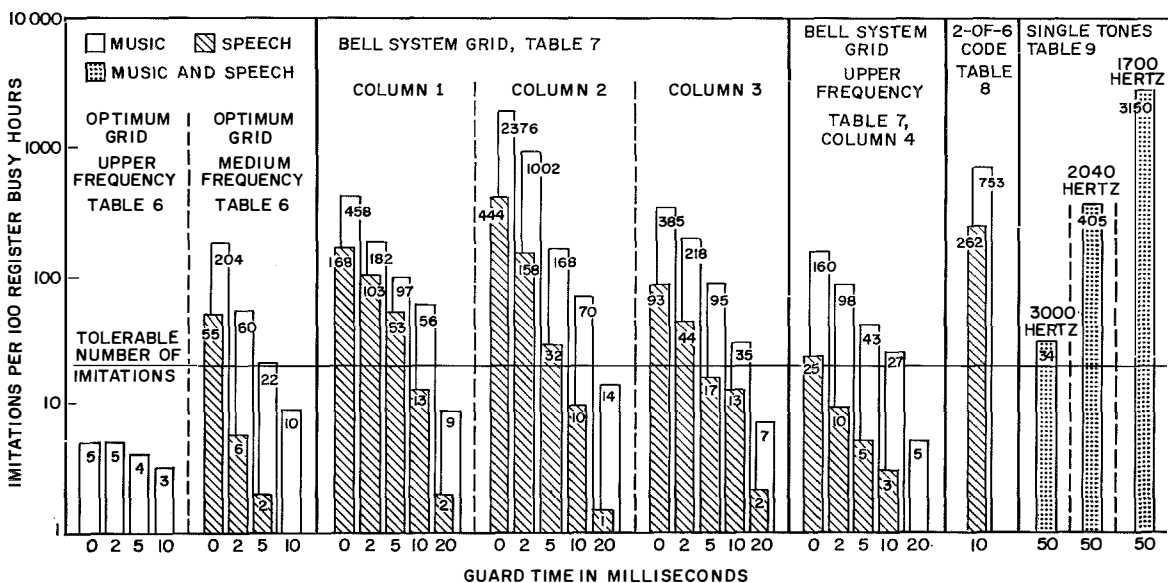

Figure 18—Summary of results given in Tables 6-9.

only a minor advantage in speech immunity but also allows for greater bandwidth, which in turn lowers the equipment cost. Moreover, the modified grid can tolerate a relatively low guard factor and is therefore less susceptible to line noise, which is significant for actual operation.

The requirements we have placed on speech immunity and the test method used raise the question whether the yardstick applied to the system is too severe. This may be the case, but it seems justified to apply stringent specifications because the introduction of a new signaling method calls for exceptional care and caution. Only operational experience can determine whether and to what degree specifications for speech immunity may be liberalized; even then the actual benefit to the system should be appraised before any concession is made.

On completion of the investigations described in this paper, Standard Elektrik Lorenz developed a 2-group-code push-button signaling system in which the signal frequencies are located in the upper voice-frequency band. All 16 possible combinations may be used. This system was cut over in the Stuttgart local network together with a quasi-electronic switching system [25] in July 1963.

### 6. References

1. F. Trendelenburg, "Klänge und Geräusche," Verlag Julius Springer, Berlin; 1935.
2. W. Fuchs, "Die mathematischen Gesetze der Bildung von Sprachelementen aus ihren Bestandteilen," *Nachrichtentechnische Fachzeitschrift*, volume II, 1956, reprint 1957; page 7.
3. K. Kupfmüller and O. Warms, "Sprachsynthese aus Lauten," *Nachrichtentechnische Fachzeitschrift*, volume III, 1956, reprint 1957; page 28.
4. F. Winkel, "Phänomen des musikalischen Hörens," Max Hesses Verlag, Berlin und Wunsiedel; 1960.
5. W. Fuchs, "Mathematische Analyse der Formalstruktur von Musik," Forschungsberichte des Wirtschafts- und Verkehrsministeriums, Nordrhein-Westfalen; number 357.
6. H. Backhaus, "Über die Bedeutung der Ausgleichsvorgänge in der Akustik," *Zeitschrift für technische Physik*, volume 13, number 1, pages 31–46; 1932.
7. T. H. Flowers and D. A. Weir, "The Influence of Signal Imitation on Reception of Voice-Frequency Signals," *Proceedings of the Institution of Electrical Engineers*, volume 96, part 3, number 41, pages 223–235; May 1949. Also, *Electrical Communication*, volume 26, pages 319–337; December 1949.
8. H. Bendel, "Neuere Entwicklungen auf dem Gebiet der Tonwählempfänger," *Nachrichtentechnische Zeitschrift*, volume 8, number 4, page 146; 1956.
9. M. Den Hertog, "Interregister Multifrequency-Code Signalling for Telephone Switching in Europe," *Electrical Communication*, volume 38, number 1, pages 130–164; 1963.
10. N. Pausch, A. Pfau, and E. Pfeleiderer, "Ein Mehrfrequenzcode-Wählverfahren für weltweiten Fernsprechwählverkehr," *Nachrichtentechnische Zeitschrift*, volume 14, number 11, page 560; 1961.
11. L. Schenker, "Push-Button Calling with a Two-Group Voice-Frequency Code," *Bell System Technical Journal*, volume 39, number 1, pages 235–255; 1960.
12. F. A. Stallworthy and B. Drake, Siemens Edison Swan Limited, London. Auslegeschrift 1 131 752 Kl 21a 3 61/40 Deutsches Patentamt. As dated June 20, 1962: Schaltungsanordnung zur Mehrfrequenz-Signalübertragung in Fernmelde- insbesondere Fernsprechanlagen.
13. M. Elbe, "Der Spracheinfluss auf tonfrequente Ruf- und Wählverfahren," *Europäischer Fernsprechdienst*, number 60, page 43; 1942.

14. M. Langer, "Studien über Aufgaben der Fernsprechtechnik," Fernverkehr, Teil 2, Verlag R. v. Aldenbourg, Berlin; 1944.

15. Beckmann and R. Führer, "Tonfrequenzwahl," Technischer Bericht, number 100, published by Post- und Fernmeldetechnisches Zentralamt des Vereinigten Wirtschaftsgebietes; 20 November 1948.

16. H. Oden, "Problem der Tastwahl," *Nachrichtentechnische Zeitschrift*, volume 14, number 2, page 62; 1962.

17. R. Meisel, "Die Güte des Dienstes in Fernsprechwählnetzen," Jahrbuch des elektrischen Fernmeldewesens 1962. Verlag für Wissenschaft und Leben, Bad Windsheim.

18. F. Witting and K. P. Küstermann, "Untersuchungen über die Güte der Verkehrsabwicklung im Selbstwähl-Ferndienst," *Nachrichtentechnische Zeitschrift*, volume 15, number 4, pages 173-181; 1962.

19. F. Witting, "Mittelwertsnetzbild und Verkehrsverteilung im Fernverkehr," *Nachrichten-*

*technische Zeitschrift*, volume 15, number 4, pages 167-172; 1962.

20. R. Schmidt, "Betriebsfragen der Vermittlungstechnik," *Fernmelde-Praxis*, number 13, page 561; 1962.

21. E. Fusswinkel, "Verfahren zur Verbesserung der Verkehrsgüte im Selbstwähl-Ferndienst," *Fernmelde-Praxis*, number 9, page 377; 1963.

22. N. Tell, "Routing Numbers and Long-Distance Calling Rates," *Tele* (English Edition), number 2, page 76; 1960.

23. R. N. Battista, C. G. Morrison, and D. H. Nash, "Signaling System and Receiver for Touch-Tone Calling," *IEEE Transactions on Communication and Electronics*, number 65, pages 9-17; March 1963.

24. M. L. Benson, F. L. Crutchfield, and H. F. Hopkins, "Application of Touch-Tone Calling in the Bell System," *IEEE Transactions on Communication and Electronics*, number 65, pages 1-5; March 1963.

25. L. Gasser, "Tastwahl in der öffentlichen Fernsprechtechnik," *SEL-Nachrichten*, volume 11, number 3, pages 150-155; 1963.

**Lorenz Gasser** was born in Prigrevica, Yugoslavia, on 23 November 1927. He studied at the Staatliche Ingenieurschule in Frankfurt am Main.

From 1944 to 1950, he was a miner in Soviet Russia. He then spent 3 years in a power station in Württemberg, Germany, before going to college.

In 1956, he joined Standard Elektrik Lorenz where he is engaged in the development of various transmission and switching techniques.

**Eugen Ganitta** was born on 15 June 1908, in Silesia, Germany. He studied physics at the Technische Hochschule in Breslau and received the Dr.-Ing. degree from the Heinrich Hertz Institute for Oscillation Research of the Technische Hochschule in Berlin.

In 1939, he joined Mix & Genest in Berlin. After serving in the second world war, he resumed his professional work with Standard Elektrik Lorenz.

Mr. Ganitta is in charge of the development of telephone sets, signaling, and transmission techniques for switching systems.

# Quasi-Electronic Telephone Switching System HE-60

H. SCHÖNEMEYER

Standard Elektrik Lorenz AG; Stuttgart, Germany

## 1. Introduction

The many novel components developed during the past two decades—such as transistors, semiconductor diodes, magnetic storage devices, and reed switches—have had a great impact on the telephone switching art. This is evident from the work carried out in the past 10 years by

government and private research and development laboratories. They have designed and built a number of trial offices to test, under both laboratory and field conditions, the new switching techniques made necessary by use of these electronic components, as well as the resulting system groupings. A trial office in Stuttgart,

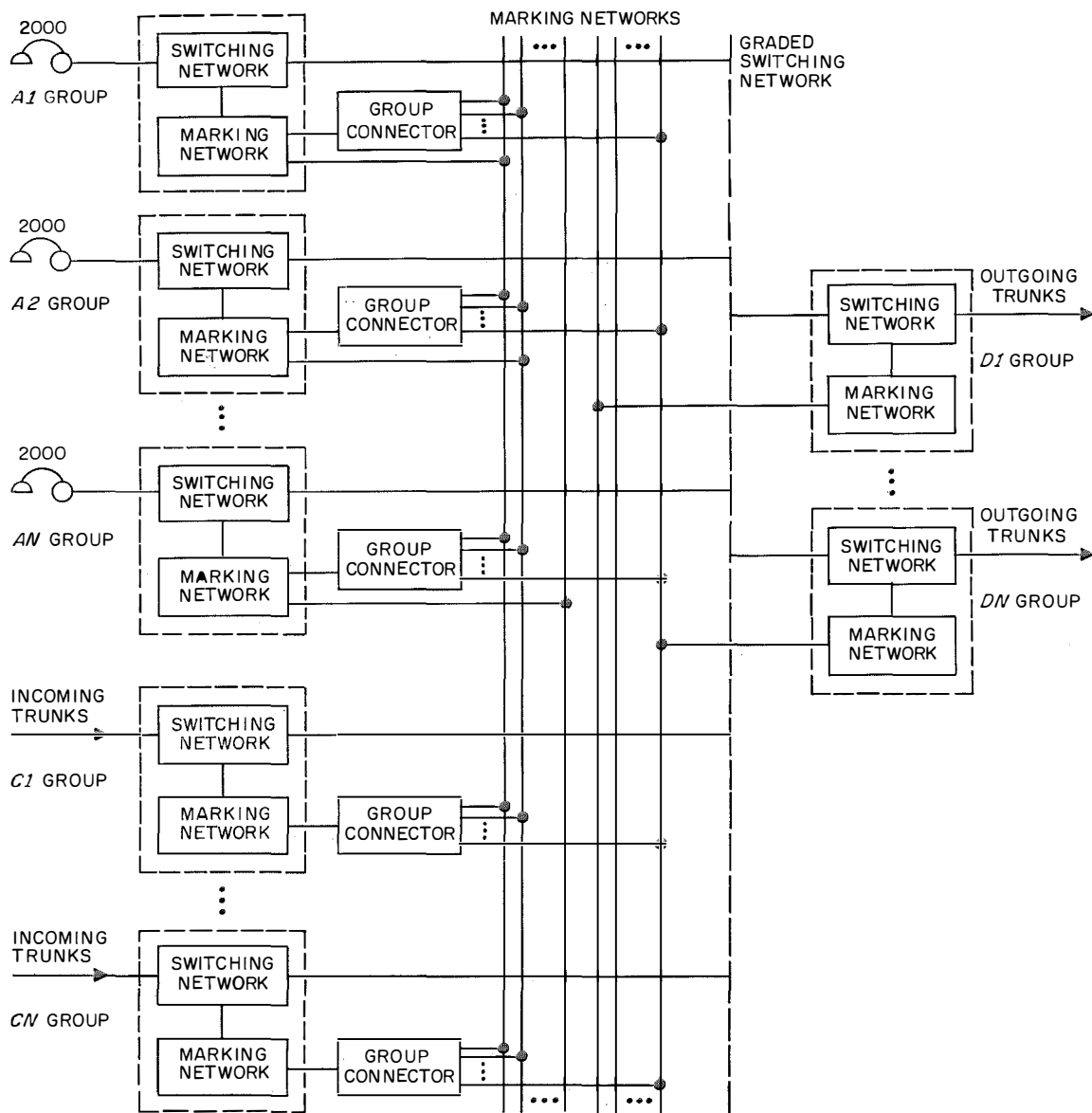

Figure 1—System grouping.

inaugurated in July 1963, is testing the HE-60 quasi-electronic system.

The basic function of a telephone switching system is to set up connections simultaneously between many pairs of subscribers for the required lengths of time. The switching network may operate on either space, time, or frequency division [1].

The system discussed in this paper is called quasi-electronic. This term indicates that there are Herkon contacts in addition to electronic components. These hermetically sealed contacts, from which the name Herkon is derived, are in the form of reed switches [2], the nickel-iron springs of which bend only approximately 0.1 millimeter (0.004 inch) in opening and closing the contacts.

Present electromechanical switching systems are so reliable that this factor is of major importance in the design of new electronic switching systems. It is well known that reliability cannot be injected into an existing system but should substantially influence the entire design.

## 2. Grouping

An important feature of electronic devices is their inherent high switching speed, which favors consolidation of control units with attendant economy. Such consolidation in the HE-60 system has been restricted to permit complete groups to be installed in smaller central offices while several such groups can make up a large exchange. Thus, one switching group serves 2000 subscribers. Larger offices will be equipped for two or more such groups. Subscribers are served by A-group equipment, and incoming and outgoing traffic are handled by C and D groups, respectively.

Figure 1 illustrates the manner in which a large central office can be made up of such groups. Within each group, connections are set up on the 1-at-a-time marking principle. However, marking operations may take place simultaneously in different groups. Calls between any two groups are handled by linking their marking networks (originating and destination groups) for the duration of a marking process.

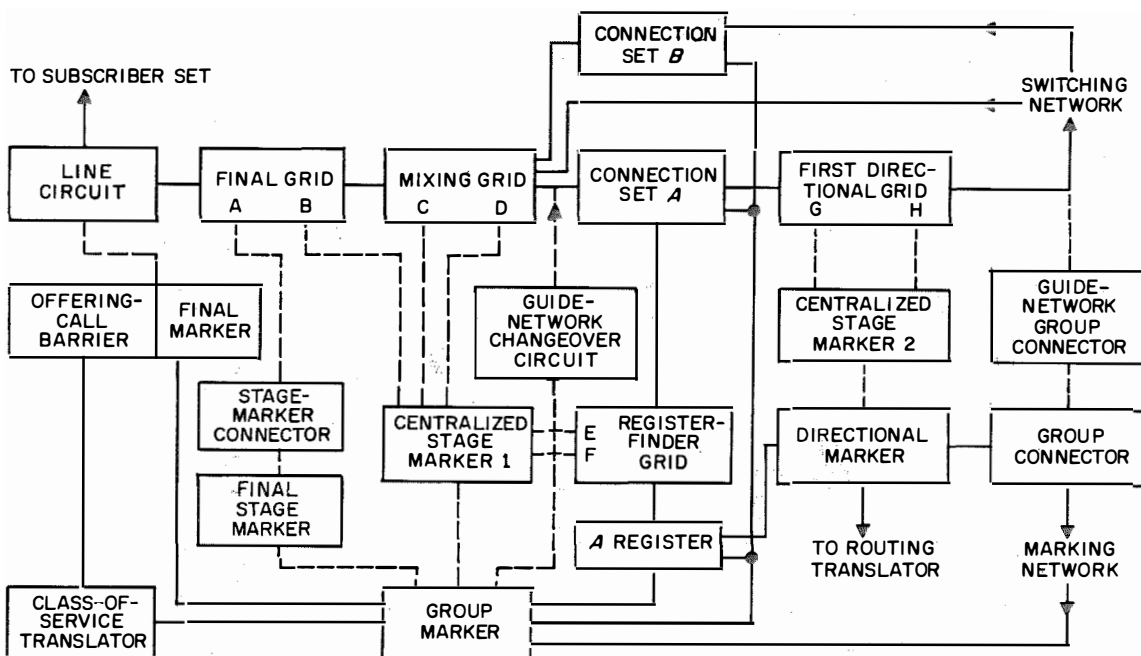

Figure 2—Layout of an A group.

## Quasi-Electronic Telephone Switching HE-60

Thus the maximum number of simultaneous marking operations possible in one central office are equal to the number of groups.

The following details of grouping schemes show a characteristic feature of reed switching networks that are achievable in any physical array. The connections are established through a relatively large number of switching stages made up of relatively small crosspoint matrixes, to minimize the total number of crosspoints. The actual size of the matrixes has been determined by traffic simulation in a computer.

### 2.1 A GROUPS

Figure 2 shows the layout of an *A* group. The subscribers' lines are combined into 100-line final grids comprising switching stages *A* and *B*. The internal arrangement of a final grid is shown in Figure 3. Stage *A* has 10 switching matrixes with 10 inlets (subscriber circuits) and up to 6 outlets (links) each. These provide up to 60 links for access to the 6 matrixes of stage *B*, which also have 10 inlets and 6 outlets each. The 100 subscriber lines are thus concentrated into 36 links that are connected via an intermediate distributing frame to stage *C* of the mixing grid, the internal arrangement of which is shown in Figure 4. Up to 20 final grids, with a total of  $20 \times 36 = 720$  links, can be cross-connected here to form 6 mixing grids.

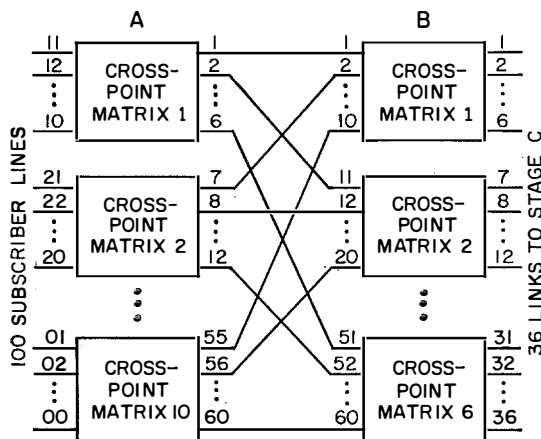

Figure 3—Link arrangement of a final grid.

Switching stage *C* contains 11 matrixes with 11 inlets and 6 outlets each. It is connected with 66 links to switching stage *D*. Normally, stage *D* is provided with 6 matrixes also having 11 inlets and 6 outlets each, so that  $11 \times 11 = 121$  inlets are concentrated in every mixing grid into 36 outlets.

Special arrangement of the links between stages *C* and *D* permits use of up to 8 matrixes in stage *D*, thereby obtaining 48 outlets in all.

Connection sets *A* and *B* (Figure 2) are connected to the point of highest concentration (stage *D*) of the switching network. Connection set *A* serves calling subscribers and has access to the *A* register via the register-finder grid, which consists of switching stages *E* and *F*. The traffic, moreover, is distributed via the first directional grid (switching stages *G* and *H*) to an intermediate distributing frame provided in common for all groups of a switching office. Connection sets *A* are combined into groups of 30 and expanded, via stage *G* (6 matrixes with 5 inlets and 12 outlets each) and stage *H* (12 matrixes with 6 inlets and 11 outlets each) to 132 outlets. The following intermediate distributing frame is provided with cross-connecting jumpers. These permit access to the inlets of connection sets *B* (serving called subscribers) of their own and of other *A* groups, as well as to the trunk groups leading to other offices and to the long-distance area. Within their own group, the outlets of connection sets *B* are connected to switching stage *D* of the mixing grid. The mixing and switching grids are used for traffic in both directions so that incoming traffic (switching stages *A* to *D*) is handled in the same way.

The crosspoints of the switching network (stages *A*, *B*, *C*, *D*, *G*, and *H*) are provided with 4-contact Herkon elements (2 contacts for the speech path, 1 for the metering lead, and 1 for the holding circuit). Switching stages *E* and *F* of the register-finder grid are equipped with 11-contact strip-mounted Herkon crosspoint elements, to permit a quick signal exchange between the *A* register and connection



set *A*. The switching matrixes of the register-finder grid have 6 inlets and 4 outlets each. The links between stages *E* and *F* are connected to an intermediate distributing frame to permit easy adaptation of the degree of concentration of the register-finder grid to the number of connection sets *A* and *A* registers required.

The control circuits are designed to permit 1-at-a-time marking only. For safety reasons, a number of special control devices have been provided that perform only certain partial operations during the call-establishing process.

The most-important duty is assigned to the group marker. It ensures that the 1-at-a-time rule is followed and monitors the entire switching process with the aid of extensive test circuits.

The final stage marker (in conjunction with the stage-marker connector) and centralized stage markers 1 and 2 serve for route finding in the switching network. The final marker (assigned to every 100-line group) enables access to the subscriber circuits for test and control purposes. The originating-call barrier (also provided for every group of 100 subscribers) ensures, in conjunction with the group marker, that only the called subscriber is marked.

The class-of-service translator contains data on subscribers. Easy access to this information during the marking process essentially increases the control flexibility of the system and allows subscriber data to be considered while the connection is being established.

The only duty of the directional marker is to establish a connection between the register and the called subscriber or an outgoing trunk line. It connects one register to the marking network and gives access to the routing translator, which is provided in common for all *A* and *C* groups of an office.

The group connector joins the originating group directional marker to the destination group marker for the duration of a marking process. The guide-network group connector and the guide-network changeover circuit are

auxiliary units used for route finding in the switching network. Operation of the former depends on the required direction, and operation of the latter depends on the marking program (refer to Section 3.2).

2.2 C GROUPS

Figure 5 shows the layout of a *C* group. Incoming lines from other central offices and from the long-distance area arrive at connection set *C*, which has access to the *C* register via switching stages *E* and *F* of the register-finder grid. As soon as a connection set *C* is seized, group marker *C*, in conjunction with centralized stage marker 1, effects through-connection to the *C* register.

The directional marker, centralized stage marker 2, the group connector, the guide-network group connector, and the routing translator of the *C* group operate identically to the corresponding units of the *A* group. The switching path runs from connection set *C* via

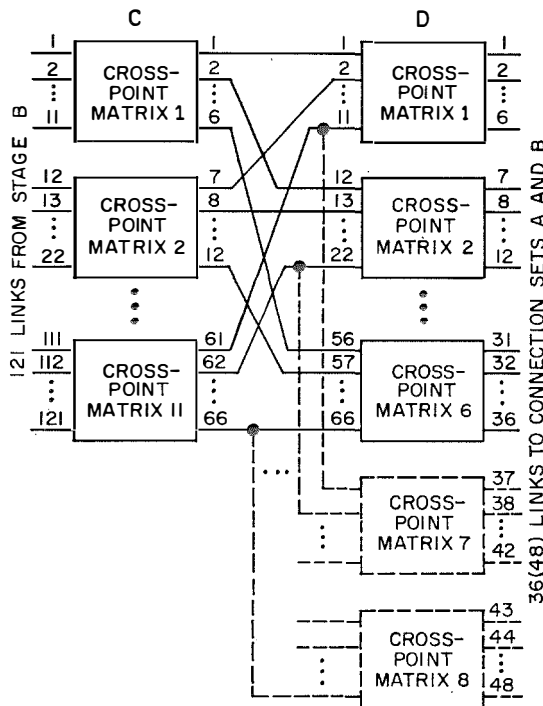

Figure 4—Link arrangement of a mixing grid.

stages *G* and *H* of the first directional grid to the intermediate distributing frame, which is assigned in common to all groups. The intermediate distributing frame is provided with cross-connecting jumpers that permit access to all *A* groups and, if transit traffic is handled by the office, also to the *D* groups.

### 2.3 *D* GROUPS

Figure 6 illustrates the layout of a *D* group, which handles the outgoing traffic to other central offices and to the long-distance network.

Access to group marker *D* is obtained via the group connector of the *A* groups and, if required, of the *C* groups. Group marker *D* controls the sequence of operations. The information on the wanted trunk group is received by the guide-network trunk connector, which then marks all free trunks available in the group. The function of the centralized stage marker is to find a route through the second and third directional grids. Depending on the particular local requirements, the switching network may be arranged to provide a maximum of flexibility. For example, outgoing trunk groups with a high traffic load may be branched off right after stage *H* of the *A* and *C* groups and wired directly to connection sets *D*, which switch the marking paths to the individual outgoing trunks. Connection sets *D* are also used for adaptation to the particular conditions of indi-

vidual trunks. The switching network expands further through the second and third directional grids, which comprise switching stages *J*, *K*, *L*, and *M*, to provide access to smaller trunk groups and special services (for example, absentee service or changed-number announcements). The matrixes of the first and second directional grids are kept especially small, with 4 inlets and 6 outlets. Thus with a completely meshed link arrangement, directional grids could be formed with 4 matrixes in the input stage and 6 matrixes in the output stage; that is, with 16 inlets and 36 outlets.

### 2.4 ARRANGEMENT OF GROUPS IN STUTTGART TRIAL OFFICE

The Stuttgart trial office of the *HE-60* quasi-electronic system is designed to serve 2000 subscribers. One *A* group would therefore be sufficient. To be able to demonstrate the interworking of groups, however, two *A* groups have been provided, the *A1* (standard-service) group for 1500 subscribers and the *A2* (augmented-service) group for 500 subscribers. The latter group are offered special services. They may use either standard dial-type or push-button-selection telephone sets, the registers being able to handle both kinds of dialing information. The class-of-service translator contains a ferrite storage unit with 6 ring cores per subscriber. This storage unit permits oper-

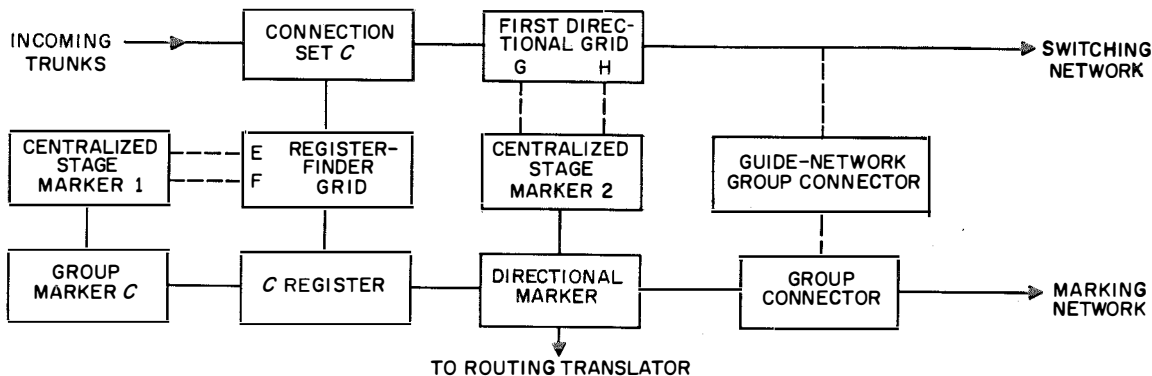

Figure 5—Layout of a *C* group.

ator- or subscriber-controlled switching to absentee and changed-number services. Announcement service is available whereby for a time determined by a subscriber all calls for that subscriber are diverted to an operator or to a recorded announcement service. Abbreviated-dialing service is also available to a limited number of subscribers.

The incoming traffic flows over 117 lines from 3 local junction centers to the trial office, where it is handled by one *C* group.

Although one *D* group would be fully capable of handling the outgoing traffic that flows through 141 lines in 11 directions, two *D* groups have been provided in the trial office. They are thus able to demonstrate rerouting from group to group in the event of overflow.

**3. Control**

In conventional step-by-step switching offices, each switching stage is associated with a particular digit of the telephone number. The connection is set up digit by digit as each is dialed by the calling party, and major parts of the

future speech path are switched through before the desired subscriber is actually known. On the other hand, the *HE-60* is a comprehensively controlled register-type switching system. The number of switching steps are independent of the length of the called number and are determined solely by the switching operations required to assemble the speech path. Alternative switching paths are available, thereby assuring a minimum of traffic blocking.

When a subscriber's handset is lifted, the *A* register is reached by a first marking process, via connection set *A* and stages *A* through *F*. The calling subscriber may now dial the desired number into the register, where it is stored. When the entire number (or at least sufficient information for one switching operation) has been stored, the register calls the directional marker, which then initiates the second marking process. In this manner, the connection is built up from connection set *A* (seized during the first marking operation) to the desired subscriber or outgoing trunk. In either case, the route is selected with the aid of a guide-wire procedure.

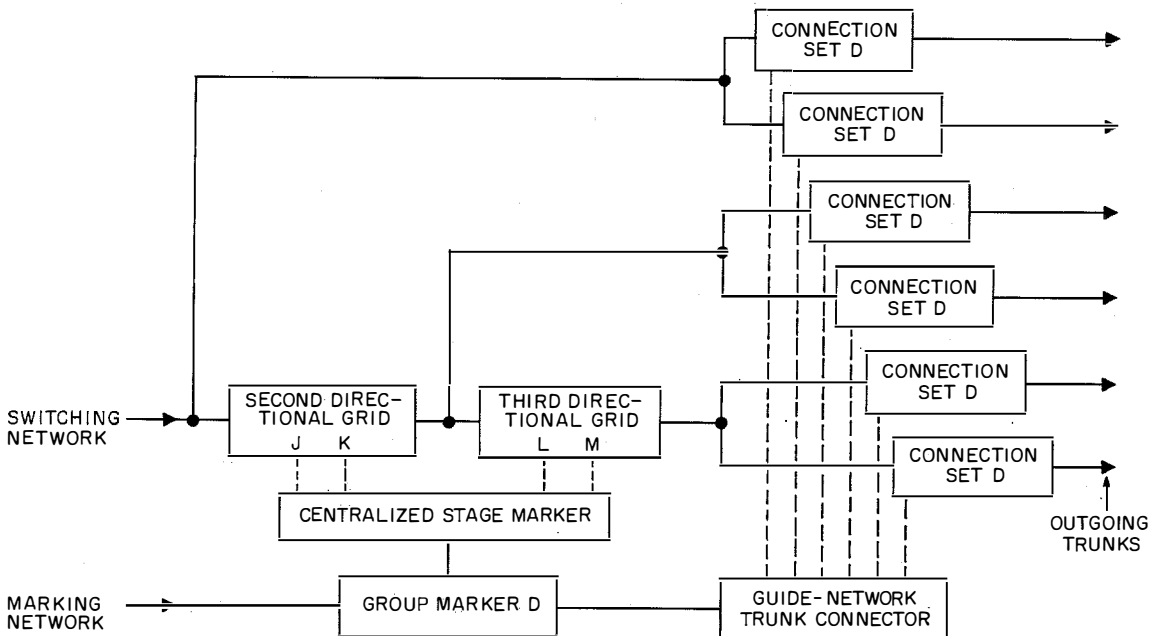

Figure 6—Layout of a *D* group.

### 3.1 ROUTE FINDING BY GUIDE-WIRE METHOD

By providing the control system with sufficient information to assemble a speech path from even the last free links, good use can be made of the crosspoint elements and their quantity can be reduced accordingly.

A guide wire  $M$  (see Figure 7) is run parallel to speech-path wires  $A$  and  $B$ , metering wire  $Z$ , and holding wire  $C$ . The contacts of the crosspoint elements switch the speech-path and auxiliary wires, but not the guide wire. The guide wires are combined in every switching matrix by a diode multiple connected to an electronic amplifier (offering-signal regenerator).

Figure 7 shows part of a switching matrix and the essential details for control. During route finding and route selection, two distinct signals act on the guide wire. An offering signal is applied to the guide wire of the calling circuit. This signal then fans out stage by stage to the registers and marks all free and accessible links to the called subscriber's circuit. Signal regeneration takes place in every matrix. Thus it is possible to recognize immediately whether a connection can be set up and which links are available.

All free registers reached by the offering signal pass it to the group marker, which selects one register by means of a pick-out chain and seizes it by applying an accepting signal to the guide wire in a direction opposite to the offering signal. Through seizure of the register, a particular switching matrix and its outlet in switching stage  $F$  are also determined. The accepting signal causes this matrix to be connected to centralized stage marker 1, whose electronic pick-out chain tests all inlets and selects one that has been marked by the offering signal. The accepting signal is then transmitted to switching stage  $E$  where it causes centralized stage marker 1 to be connected again. The same operations are repeated in every stage until the called subscriber's circuit is reached. A definite route, made up of links marked avail-

able, is thus established during the accepting process.

Note that the accepting signal can establish a route only if the offering signal has passed through the entire switching network, thus indicating that a connection is possible. Since the offering signal acts as a pilot, marking only free links, the connection cannot be blocked. Figure 8 shows the spreading of an offering fan. Obviously, the guide-wire method offers not only a way to obtain exact information quickly on whether a connection can be established, but also permits flexible design of the switching network. Another advantage is that marker modifications are not required in the event of system expansion or changes of the grading arrangement, since the guide wire—which is also jumpered in such cases—is provided with all information needed by the marking network.

### 3.2 INTERWORKING OF GROUPS

The system is designed to permit several simultaneous marking operations to take place in different groups. For example, marking may be in progress from one of connection sets  $A$  ( $A$  register) of the  $A1$  group to the  $D1$  group. At the same time, another marking takes place from the  $C1$  group to a subscriber of the  $A1$  group or a calling subscriber of the  $A1$  group is switched to a free register. This is possible because the control units of the individual groups have been subdivided into specialized equipments, some of which are used only for incoming and others only for outgoing traffic. Also, the guide-network group connector switches only those parts of the guide network that lead to the group switched in the marking network. A collision of the fanned offering signals produced by the different marking operations is thus prevented. As several marking operations may take place simultaneously in a large switching office, the markers do not need the high operating speed they possess. The route finding is entirely electronic and

produces no interference of the type caused by the switching of inductive loads.

The control units have also been equipped with Herkon relays where their long life and high switching speed could be used most effectively. The mechanical separation of the many hermetically sealed contacts increases their direct-current isolation and reduces the effects of electrical disturbances from neighboring circuits.

#### 4. Reliability

It is impossible to produce technical equipment possessing absolute operational reliability. A certain—even if very low—percentage of com-

ponents is bound to fail during equipment life, or at least exceed the tolerance limits of one characteristic. However, it is possible to restrict both the number of failures and the degree to which each failure affects the operation of the system. This was a controlling reason for separating the system into groups. However, a number of additional steps have been taken to increase system reliability.

Assuming that short-time failures of up to 100 subscriber lines are tolerable, all control equipments serving more than 100 lines were duplicated. This means that the group marker, directional marker, centralized stage markers 1 and

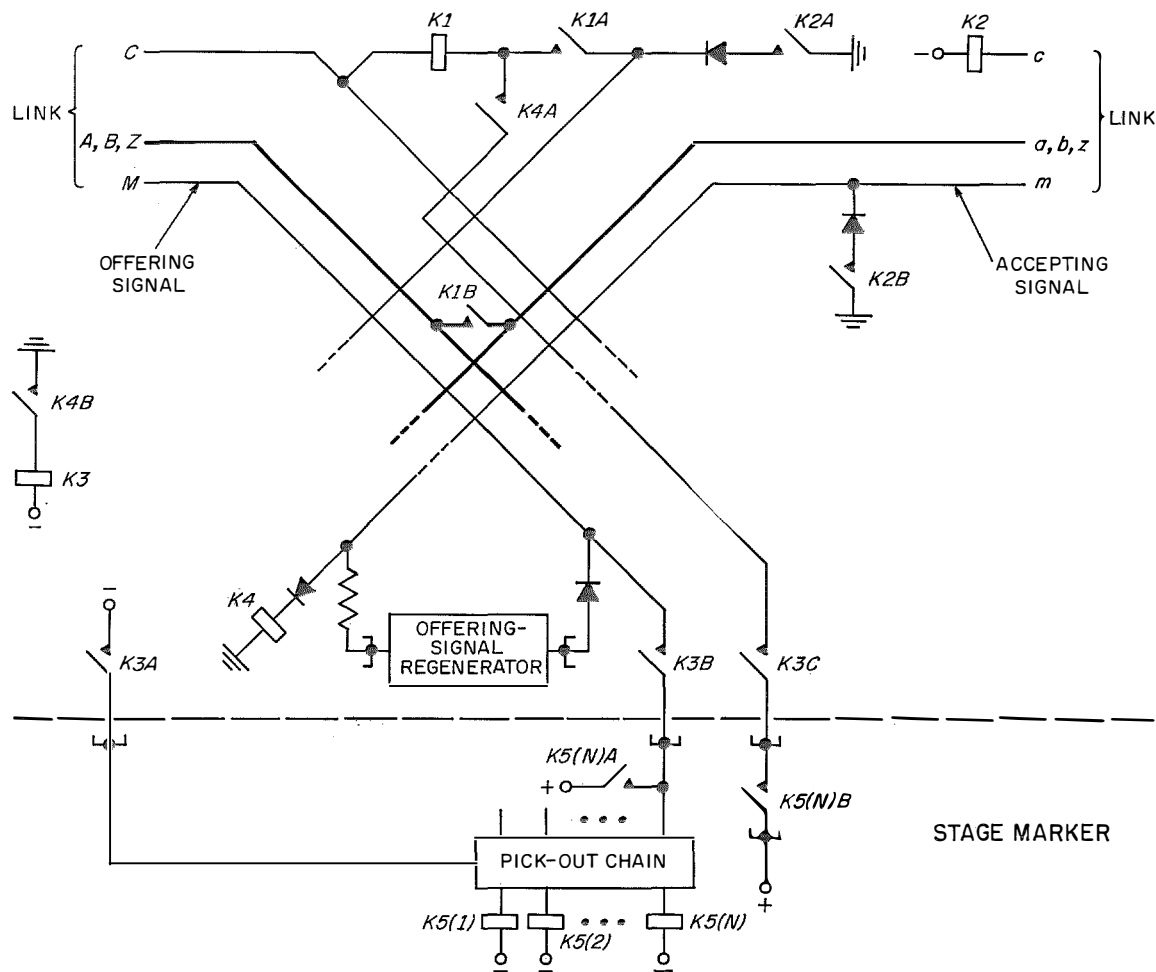

Figure 7—Simplified diagram of switching matrix.

## Quasi-Electronic Telephone Switching HE-60

2, and the final stage marker have been duplicated in every group. The class-of-service translator is sufficiently decentralized to make duplication unnecessary. The final markers and originating-call barriers also have not been duplicated as each of them is associated with only 1 hundreds group. Furthermore, any fail-

ing unit can be repaired quickly and easily because of the use of plug-in modules.

The information paths between duplicated equipments, as well as the access paths from the switching network and the registers to the marking network, also have been duplicated.

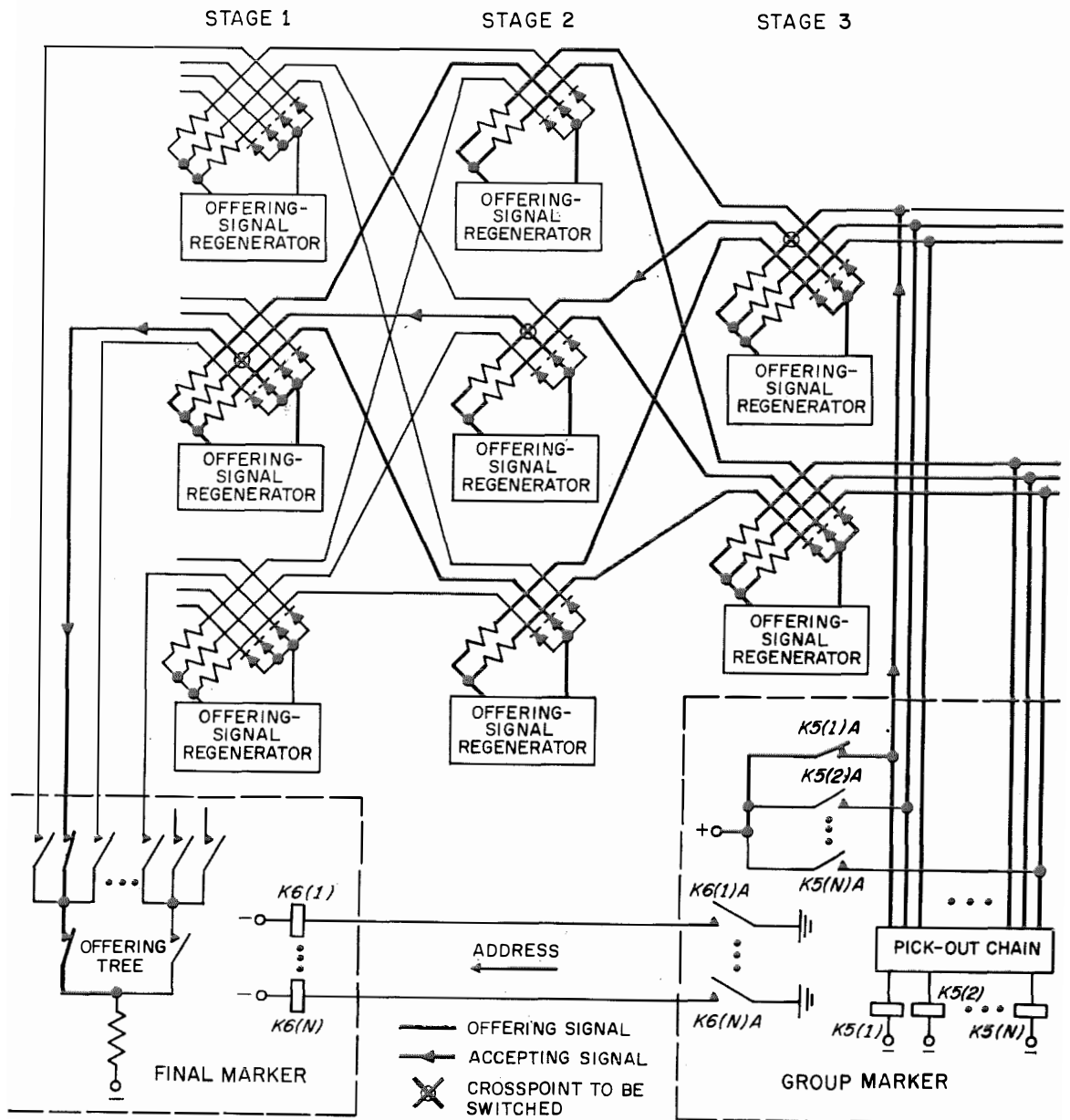

Figure 8—Fanning out and acceptance of an offering signal.

Each of the centralized stage markers serves half of the switching matrixes of the individual stages. In case of a failure in this unit, parts of the switching network thus become unusable. The entire subscriber traffic is then handled by the other centralized stage marker, though with a higher loss probability.

The dialing information passed by the register to the marking network, plus a number of significant instructions and signals to be exchanged in the marking network, are transmitted in the form of self-checking codes. In addition, the markers have been provided with comprehensive monitoring test circuits. When a fault is detected, the marker is blocked and an alarm is initiated. The duplicated markers operate alternately. If one blocks and sets off an alarm, the other handles the entire traffic.

#### 4.1 PATH TESTING IN THE SWITCHING NETWORK

In switching networks designed as multistage link systems and equipped with centralized control, it is extremely difficult (hence not advisable) to provide the test points and counting potentials for every link normally used for routine testing. Therefore, no conventional provisions have been made in the *HE-60* system for routine testing of the speech paths and the metering leads. Instead, the group markers and directional markers have been equipped with path-testing devices that are much more effective. During each marking process, they test the links making up a speech path for external potential (connection to other speech paths) and proper counting potential for the destination (subscriber circuit or connection set *D* of an outgoing trunk).

#### 4.2 PATH TESTING IN THE MARKING NETWORK

The dialing information as well as the majority of control instructions and signals are protected by a self-checking code. All other marking-network wires used to transmit information or

switching instructions are tested for proper counting potential before the signal is transmitted. When a fault is detected, the marking process is stopped, the marker blocks, and an alarm is actuated. The entire traffic is then handled by the alternate marker over other information paths.

#### 4.3 ERROR DETECTION AND DATA MEMORY FOR RECOGNITION OF FAILURES

In centralized systems, the marking units are busy for only a relatively short time with the execution of marking operations. On completion of a marking operation, they are immediately available for the next operation. For this reason, it is not possible to render any links inactive for fault-localizing purposes, as in step-by-step switching systems with individual control.

In the *HE-60* system, therefore, the markers are designed to monitor their own operation and to check codes, test paths, et cetera, so that they have exact data available whenever a failure occurs. It would be very expensive to pinpoint the trouble in the switching network, or in a particular specialized unit, by means of automatic facilities. Therefore, a data memory has been provided for recognition of failures. This has a 120-word capacity (in 2-out-of-5 code) and works in conjunction with a tape punch. Whenever a marker detects a fault, it calls this data memory (thereby locking the marker out from other seizures) and supplies all information present in the groups involved in the marking process (both in the switching and marking networks). In this manner it is possible to determine the originating group, destination group, duplicated markers, activated registers, matrixes of the individual stages as well as their active inlets and outlets, and the transmitted dialing information. All data are then recorded on punched tape. When several fault telegrams (presumably caused by the same fault) have been received, the location of the fault can be derived with a high degree of probability from the information coincidence.

## Quasi-Electronic Telephone Switching HE-60

For demonstration purposes, the stored information is also displayed in the Stuttgart trial office by means of lights and illuminated changing numerals.

### 4.4 CIRCUIT MARGINS

Every component used has certain manufacturing tolerances. Also, supply-voltage fluctuations and ambient-temperature variations are unavoidable. With this knowledge, all circuits have been designed to assure satisfactory performance even under worst-case conditions. When designing the circuits, the extreme admissible values of electrical characteristics were considered. Maximum voltage fluctuations and temperatures, including the temperature rise caused by heat dissipation in the equipment, also were taken into account.

For supply voltages,  $-36 \pm 3$  and  $+24 \pm 2$  volts measured to ground have been chosen. These unequal voltages are well suited for the transistor circuits employed. Any leakage to ground operates against only one of these voltages, reducing the heat dissipated in the leakage path. Both voltages in series provide 60 volts for subscribers' lines.

### 5. System Features

A detailed description of the *HE-60* system features would be beyond the scope of this paper.

The Stuttgart trial office, the first application of this system, is of course compatible with the telephone network of the German Bundespost. It incorporates all standard features required by this administration's specifications. Since the signals on the incoming and outgoing lines also comply with these specifications, it is capable of interworking with other central offices of the Stuttgart local network as well as with the long-distance network.

For exchange of information with other offices, direct-current signaling is used in the trial office to meet the particular local conditions. When

working in conjunction with offices designed on the same principles, the *HE-60* system will use a multifrequency code. The system also meets the following stringent requirements.

(A) Subscriber loop resistance  $\leq 1500$  ohms.

(B) Subscriber line leakage (also to ground)  $\cong 20\,000$  ohms.

(C) Protection of equipment if subscriber loop touches a 220-volt power line.

(D) Subscriber lines must be operable with inductive interference from 60-volt networks operating at  $16\frac{2}{3}$  and 50 hertz.

(E) Local junction lines must be operable with inductive interference from 15-volt (statistically 20-volt) networks operating at  $16\frac{2}{3}$  and 50 hertz.

Of course, 2-party lines and in-dialing to private automatic branch exchanges have been provided for, and groups of private branch exchanges can be accommodated with no need for consecutive numbering (within one 2000-line group). The *HE-60* system, being register controlled, permits use of push-button stations (Figure 9) working with multifrequency code selection.

In the augmented-service group, additional services, such as operator- or subscriber-controlled switching to absentee and changed-number services, announcement service, and abbreviated dialing are being offered.

In addition, alternative-routing facility is provided for in the city network.

### 6. Mechanical Design

By using electronic components and Herkon relays throughout, a compact design has been achieved. The Standard Equipment Practice for ITT Europe [3] was particularly helpful as it permits good use of rack depth. Its high-reliability connector is used for the printed-circuit cards and plug-in units to the rack wiring. By inserting adapters between plug-in units and racks, easy access is obtained to indi-



vidual components, subassemblies, and terminals, even when the equipment is operating.

The plug-in units are arranged in 8 rows of 5 units each, in a rack approximately 60 centimeters (24 inches) wide and 235 centimeters (92 inches) high. One rack thus accommodates 40 plug-in units. A frame in the middle of the rack holds the main fuses, individual fuses, push buttons, and connectors for test-equipment access.

The racks are installed side by side. A total of 5 rows of racks have been installed in the Stuttgart trial office, 2 of them uncovered for demonstration purposes (Figure 10).

The 4-contact Herkon crosspoint elements are mounted on strips in the frame with a number of such strips making up a switching matrix (Figure 11). The Herkon contacts have been arranged in the operating coils so that both vertical and horizontal wiring can be accomplished with bare wires. Multicontact Herkon relays, combined on strips, are used as connectors to the marking network. The electronic components are mounted on printed-circuit boards, a variety of which are accommodated in the plug-in units.

Conventional soldering methods are used to interconnect the components and printed-circuit boards. Solderless wrapping technique has been used for internal rack and installation connectors, however, to gain experience in the German Bundespost area with this technique.

## 7. Summary

The salient features of the *HE-60* system follow.

(A) It is a quasi-electronic system using dry reed contacts, which are the only moving parts.

(B) The speech path is switched through on the space-division principle, using a multistage link arrangement.

(C) The design of the switching network assures high flexibility in case of system expansion, with regard to both the number of



Figure 9—Push-button subscriber station.

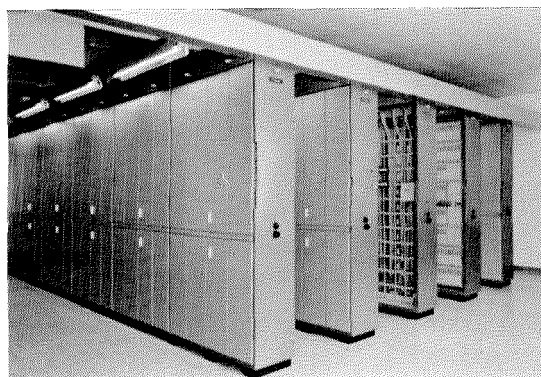

Figure 10—Stuttgart trial office.

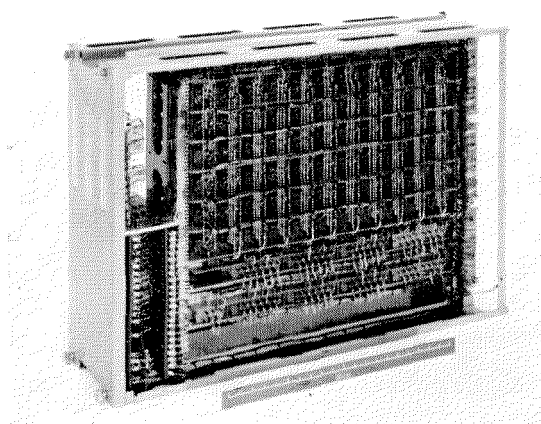

Figure 11—Switching matrix.

## Quasi-Electronic Telephone Switching HE-60

subscribers served and the volume of traffic handled.

(D) The guide-wire method for path selection permits finding even the last path available for a connection.

(E) The dialing pulses are stored in registers.

(F) The subscriber lines have been combined into 2000-line groups; one marking process may take place in each group independently of all other groups.

(G) Control is indirect and comprehensive, and is independent of the selection stages.

(H) All centralized units, including the markers of the individual groups and the information paths, have been duplicated for reliability.

(I) Comprehensive routing control is possible, not only within a central office but also within a local area, by providing registers and routing translators. The effects of troubles in the cable network can thus be minimized.

(J) Conventional existing central offices need not be modified to work with the new system.

(K) Both dial-type and push-button subscriber stations may be connected to the system.

(L) Only two voltages are used to supply power:  $-36$  and  $+24$  volts. These voltages in series (60 volts) are required in some units merely for signal exchange with conventional systems.

(M) Augmented service includes push-button subscribers' stations, abbreviated dialing to frequently called subscribers, operator- or subscriber-controlled switching to absentee and changed-number services, announcement services, et cetera.

(N) All equipment assemblies are designed as plug-in units and the electronic components are mounted on printed-circuit boards.

The equipments and circuit principles have been thoroughly tested in the laboratory under simulated field conditions. They are now under-

going further stringent tests at the Stuttgart trial office. The results of this trial will advance the telephone switching art.

## 8. References

1. H. Oden, "Aktuelle Probleme der Vermittlungstechnik," *SEL-Nachrichten*, volume 20, number 3, pages 125–138; 1962.
2. O. M. Hovgaard and G. E. Perreault, "Development of Reed Switches and Relays," *Bell System Technical Journal*, volume 34, number 2, pages 309–332; March 1955.
3. F. Beerbaum, J. Evans, and F. Leyssens, "Standard Equipment Practice for ITT Europe," *Electrical Communication*, volume 39, number 2, pages 199–211; 1964.
4. H. Rensch, "Magnetkreise von hermetische abgeschlossenen Kontakten in Schutzgasatmosphäre," *Nachrichtentechnische Zeitschrift*, volume 12, number 12, pages 625–629; 1959. Also in *SEL-Nachrichten*, volume 8, number 1, pages 24–28; 1960.
5. R. Scheidig, "Herkonrelais 80, eine Relaisreihe mit hermetische abgeschlossenen Kontakten für gedruckte Schaltungen," *SEL-Nachrichten*, volume 7, number 1, pages 6–8; 1959.
6. H. Rensch and J. Bernutz, "Probleme bei der Entwicklung von Schutzrohrkontakt-Relais in Aufreihbauweise," *Fernmelde-Praxis*, volume 39, number 11, pages 491–505; 1962.

## 9. Appendix: Establishment of Connections

### 9.1 CALLING SUBSCRIBER TO *A* REGISTER

When a subscriber lifts his handset, the closing loop acts directly on the offering-signal regenerator of his switching matrix in stage *A*. The offering signal fans out from there across switching stages *B* through *F* and the registers to the *A*-group marker. The accepting signal establishes a route with the aid of the centralized stage marker and the final stage marker, seizing a register and a connection set *A* in the

process. On reaching switching stage *A*, the address of the calling subscriber is given to the class-of-service translator, thus enabling it to furnish all data on this subscriber to the group marker. Any changeovers required in connection set *A* (which has just been seized) can be carried out in this way before completion of the marking, and information can be transmitted to the register for storage during the ensuing establishment of connection. The register transmits dial tone to the calling subscriber to indicate that it is ready to receive dialing information.

## 9.2 CONNECTION SET *A* TO CALLED SUBSCRIBER

On receiving the wanted number from the calling subscriber (and storing all digits in 2-out-of-5 code), the register calls the directional marker. A pick-out chain ensures that only one marking, from one register, is carried out at a time. The dialing information passes in parallel code form to the directional marker and from there to the routing translator. Here, a gate circuit associated with the particular input information is actuated. It supplies a specific information line containing additional control instructions (group, outgoing trunk group, alternative trunk groups available, et cetera) for the directional marker. The routing translator is then released and, with the aid of the information obtained, a signal is transmitted by the directional marker to the group marker of the destination group. A pick-out chain in the group marker actuates the group connector, so that the marking network is now linked from the directional marker via the group connector to the group marker for the duration of a marking process. The required parts of the calling number are transmitted—again in parallel code form—by the directional marker of the originating group to the group marker of the destination group, which thereupon effects through-connection to the desired hundreds group. The units and tens information causes a Herkon

relay tree in the final marker of the hundreds group to connect through, thus giving access to the wanted subscriber via the marking network. The group marker is now able to test the trunk for busy or free condition and to apply the offering signal.

To assure that an unambiguous route is established to the wanted subscriber, the originating-call barriers of the entire destination group are activated for the duration of the marking process, to prevent call origination. The guide-network changeover circuit has been set earlier by the group marker so that the offering signal fans out from the subscriber circuit of the called subscriber via switching stages *A* through *D*, connection sets *B*, and the intermediate distributing frame until it reaches the first directional grid of the originating group. On the output side of stage *H* of the first directional grid, the guide wires pass through the guide-network group connector where, controlled by the position of the group connector of the originating group, only the wires leading to the destination group are switched through.

In this way, the offering signal can be transmitted to connection sets *A* of the originating group (and only to this group) via switching stages *H* and *G*. It can return from there via a switched lead of the register-finder grid to the register and into the marking network, where it is immediately clear whether a connection with the called subscriber can be set up. From the marking network, an accepting signal is transmitted via the register and the register-finder grid to connection set *A*, thereby initiating route finding beginning with the stage-*G* input. In the originating group, centralized stage marker 2 of the first directional grid is actuated; in the destination group (beginning with stage *D*) centralized stage marker 1 and the final stage marker are actuated. When the called subscriber is reached, the marking process is terminated and the connection between the originating and the destination group is cancelled through release of the group connector.

As access to the class-of-service translator had been obtained (by the final marker supplying the address) before the route-finding process commenced, all information preventing the establishment of a connection is available in the group marker in case of need (for example, blocking) and can be passed to the directional marker of the originating group. The directional marker, on release of the marking network to the destination group, may then send a new inquiry to the routing translator and set up a connection to another group (for example, *D* group) and to announcement services.

### 9.3 CONNECTION SET *A* TO OUTGOING TRUNK

If the routing translator, on transmission of the dialing information from the register to the directional marker, indicates that the required connection is to another central office or to the long-distance area, the directional marker calls the marker of the *D* group associated with the outgoing trunk group. This group marker ensures 1-at-a-time operation by means of a pick-out chain and effects through-connection of the group connector of the originating group. The address of the outgoing trunk group, received from the routing translator, is transmitted via group marker *D* to the guide-network trunk connector and is passed from there to all connection sets *D* of the wanted trunk group. All connection sets *D* having free trunks now apply an offering signal to the guide wire. Depending on the system arrangement, the offering signal fans out either over the third, second, and first directional grids; over the second and first directional grids; or only over the first directional grid. It returns to the marker via connection set *A*, the register-finder grid, and the register. Here too, route finding begins in stage *G* of the first directional grid of the originating group and is controlled by centralized stage marker 2. Depending on the location of connection set *D*, it terminates at the last stage of the first directional grid (stage *H*), of the second directional grid (stage *K*), or of the third directional grid (stage *M*).

If group marker *D* recognizes that no trunk in the required direction is free or that no route is available to a free trunk because of the switching-network structure (this is recognized by no offering signal returning), it transmits this information to the directional marker of the originating group. The directional marker thereupon obtains from the routing translator an alternative trunk group, if provided, that can now be used. In this manner, routing control is possible in the system and one or more overflow lines can be provided; the alternative routes are not required to be associated with the same *D* group.

### 9.4 CONNECTION SET *C* TO *C* REGISTER

If a line from another central office to a connection set *C* is seized, this connection set transmits offering signals to group marker *C* via the register-finder grid and the available registers. The pick-out chain of the group marker selects one of the registers and a route to connection set *C* is selected and switched through with the aid of centralized stage marker 1.

### 9.5 CONNECTION SET *C* TO CALLED SUBSCRIBER OR OUTGOING TRUNK

On receiving the dialed number, the *C* register calls the directional marker, which transmits the stored dialing information to the routing selector. The routing translator then supplies the register with directional control information. When the destination group (which may be either an *A* group or a *C* group) is reached, marking operations and route finding proceed as described in Sections 9.2 and 9.3.

**Hilmar Schönemeyer** was born in 1920 at Buchfart, Thüringen, Germany. From 1939 to

1941, he studied at the engineering school of Bingen am Rhein. In 1947, he graduated as an electrical engineer from Staatliche Ingenieurschule in Esslingen am Neckar.

In 1947, he joined Standard Elektrik Lorenz as a switching engineer.

Mr. Schönemeyer is now head of a laboratory for quasi-electronic telephone exchanges.

# Harmonic Absorbing Filters in Waveguide

J. PAINE

H. S. V. REEVES

Standard Telephones and Cables Limited; St. Mary Cray, Kent, England

## 1. Introduction

A local-oscillator frequency  $f_{lo}$  is used to beat with the received signal frequency  $f_r$  at the input mixer of a microwave radio link, to produce the intermediate frequency (for example, 70 megahertz).

However, additional modulation products  $mf_r \pm nf_{lo}$  result from mechanisms that are well known [1], one of which ( $f_r + f_{lo}$ , the sum frequency) has been found undesirable. Since the sum frequency is far outside the frequency band for which the input mixer is designed, the latter probably will have a large reflection coefficient at this frequency. In addition, the waveguide will be overmoded. Therefore a cavity is formed between the input waveguide filter and the input mixer (see Figure 1). The cavity, which may have a high  $Q$  factor, has been found to be resonant in certain cases.

This increases the group delay distortion since  $f_r + f_{lo}$  remodulates with  $2f_{lo}$  to give the intermediate frequency.

Conventional designs of waveguide band-pass filters have unwanted pass bands in the range  $f_r + f_{lo}$ . These are created by the cavities becoming resonant (for example, 3 half wavelengths long at the fundamental  $TE_{10}$  mode) and also by passing other modes directly. Thus the sum frequency has also been found to be resonant between other waveguide components on the aerial side of the band-pass filter.

It has been determined empirically that for

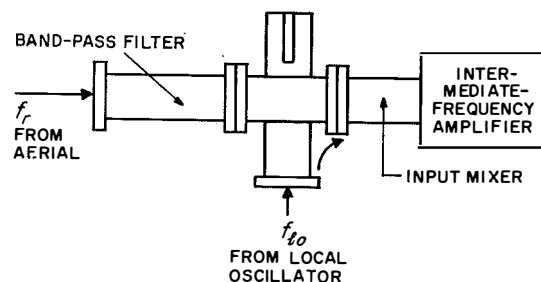

Figure 1—Input waveguide assembly of microwave receiver.

sum-frequency resonance between the input mixer and band-pass filter, dissipation of 1 decibel is enough to reduce the resulting group-delay distortion adequately.

For resonance occurring on the aerial side of the band-pass filter, the absorbing means adjacent to the mixer is not within the resonant cavity. It thus offers a return loss of just twice its dissipation, and in practice a sum-frequency loss of about 30 decibels is required. The required absorbing means must be non-reflecting at the sum frequency, as it may itself resonate with the input mixer.

It may be argued that such cases of resonance are statistically unlikely for a given set of frequencies. However, on a microwave radio link of 4 two-way super-high-frequency channels, there are 8 possibilities of such resonance at each repeater station. Thus a filter is required to pass  $f_r$  and  $f_{lo}$  individually with a low reflection coefficient and negligible loss, whilst absorbing  $f_r + f_{lo}$  with low reflection coefficient.

Another requirement for harmonic absorption occurs in radio links if transmitters and receivers are connected to a common unipolar aerial. In the International Consulting Committee on Radio frequency plan for 4000-megahertz systems, the frequency separation between adjacent transmitters and receivers of the same polarization is 97 megahertz, which results in a 27-megahertz difference between the transmitter and the local oscillator of the adjacent receiver. Consequently the third-harmonic output of the traveling-wave amplifier can mix with the third harmonic of the local oscillator to produce a spurious intermediate frequency of 81 megahertz in the receiver. System measurements indicated that an additional 50-decibel suppression of the transmitter third harmonic was required.

## 2. Sum-Frequency Absorbing Filter in Rectangular Waveguide

The main waveguide  $AB$  in Figure 2 must be chosen so that  $TE_{10}$  and  $TE_{20}$  are the only

waveguide modes that can propagate at the sum frequency. This waveguide must therefore have an aspect ratio (ratio of width to height) of at least 3. If the entire waveguide structure is symmetrical about the centre line  $XX$ , and if the receive mixer is similarly symmetrical and of the same waveguide size, the  $TE_{20}$  mode will not be generated. All energy at the sum frequency will propagate in the fundamental  $TE_{10}$  mode.

A screw  $1$  is inserted on axis  $XX$  and tuned at the sum frequency to be resonant as a band-stop filter (short circuit across the waveguide). By proper choice of screw diameter, the  $Q$  factor of the resulting frequency characteristic can be optimized so that the reflection coefficient at the fundamental frequency  $f_r$  is small.

On each side of screw  $1$ , spaced by a half wavelength at the sum frequency, are rectangular transverse slots  $5$  designed to resonate as a band-pass filter. The  $Q$  factor of these slots is

made relatively low to suit the complete range of the sum frequency, although again offering only a small reflection at  $f_r$ .

Waveguide terminations  $T$  are mounted on these transverse slots. These terminations are made with narrower waveguide than  $AB$  so that their cut-off frequency lies between  $f_r$  and the sum frequency.

Thus all the reflected energy from screw  $1$  at the sum frequency couples into the termination nearest the source. The screws  $2$  are adjusted so that, with screws  $4$  removed, a match is obtained at the sum frequency, viewed from end  $A$ . Screws  $3$  are similarly adjusted for correct match, viewed from end  $B$ . Hence screws  $2$  and  $3$  permit this filter to be used over a considerable range of sum frequencies, by compensating for the spacing of the slots from screw  $1$ , for the resonant frequency of the slots, and for the reflectivity of the absorbing dust core.

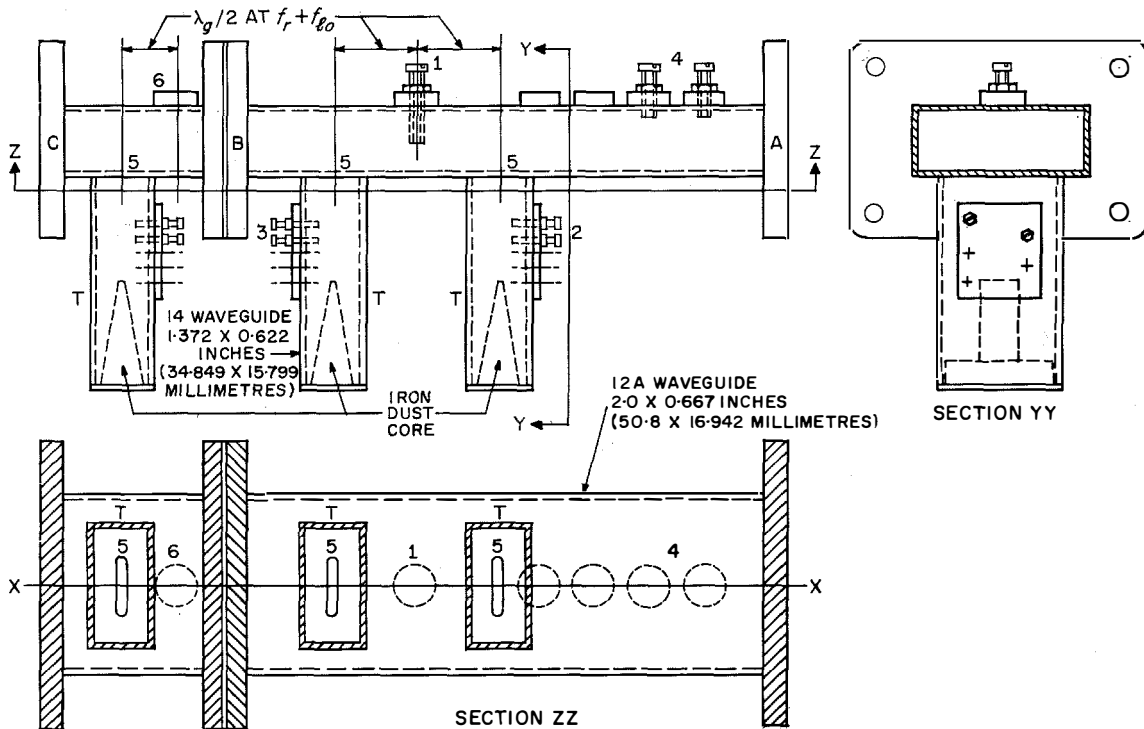

Figure 2—Sum-frequency-absorbing filter in rectangular waveguide.

## Harmonic Absorbing Filters in Waveguide

The final attenuation obtained at the sum frequency consists of the energy coupled directly into the terminations, that reflected into the terminations by screw 1, and that absorbed by screw 1.

There are sundry small mismatches at  $f_r$  because of reflections from the slots and screw 1. These are cancelled across the band  $f_r$  to  $f_{10}$  by adjusting screws 4. There is negligible dissipation at  $f_r$  as the terminated waveguides do not propagate.

The final filter will present a match at the sum frequency, looking into end B but not into end A. Therefore, end B is connected to the receive mixer. In a filter using size-12A waveguide with size-14 waveguide terminations, the sum-frequency loss within a 100-megahertz band at 8000 megahertz was about 30 decibels.

When greater loss is required, an extra section (shown in Figure 2) may be added to obtain an extra 20 to 30 decibels. A loss of 50 decibels has been achieved within a 100-megahertz band. To accomplish this, screw 6, identical to screw 1 and similarly resonant at the sum frequency, is positioned to cancel the reflection of screw 1 in the pass band at  $f_r$ . Another termination is added so that the entire filter can be matched at the sum frequency, viewed from end C.

The filter is suitable for absorbing any frequency near  $2f$ , where  $f$  is the fundamental frequency to be passed with negligible loss.

### 3. Absorbing Filter in Ridged Waveguide

If higher frequencies than  $f_r + f_{10}$  must be absorbed, or if the basic waveguide used allows higher-order modes than  $TE_{10}$  and  $TE_{20}$  to propagate, the filter can be built in ridged waveguide.

If the main waveguide AB in Figure 2 were ridged [2], its dimensions could be chosen so that only the fundamental  $TE_{10}$  mode could propagate at  $3f$ . The filter shown in Figure 3 is designed to absorb  $3f$ .

In this design, where  $f_r$  was in the band from 3600 to 4200 megahertz, the cut-off frequency  $f_c$  for mode  $TE_{10}$  was chosen to be 2950 megahertz. Size-16 waveguide was used for both the ridged waveguide and the terminations. The ridged waveguide, dimensioned in Figure 3, has a cut-off frequency of 13790 megahertz for mode  $TE_{20}$ . There were no standard-size ridged waveguides of similar mode cut-off ratio.

Except for the ridge, the basic design is the same as in the previous filter. The resonant screw 1 (short circuit at  $3f$ ) would be extremely critical to tune if placed symmetrically

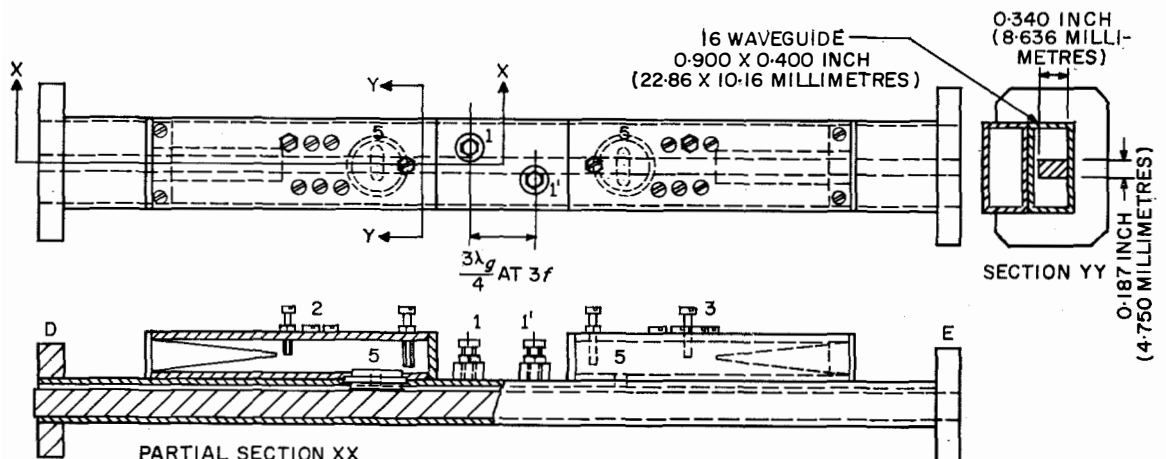

Figure 3—Absorbing filter in ridged waveguide.



opposite the ridge. It becomes easy to adjust when placed to the side of the ridge as shown, and its  $Q$  factor, which increases with its distance from the ridge, may be conveniently chosen.

Resonant slots 5 couple the energy to be absorbed into the terminations, as before. These have been placed parallel to the ridged waveguide for convenience. Again, the waveguide termination must have its  $TE_{10}$  mode cut-off frequency higher than  $f$ . A match at  $3f$  is obtained from each end by using screws 2 and 3.

Since this filter must be mated with standard rectangular waveguide in most applications, some form of transformer is needed. Conventional step transformers [3] are costly and difficult to make. The essential requirement is to have a match at  $f$  and the transition need not be a match at  $3f$ , as this is the frequency to be suppressed. The reflection loss of the transition adds to the absorption loss. Reflection loss, however, is a function of the source

and load impedances of the final circuit employed, and thus is variable.

Figure 4 shows the coupling means. A probe  $P$  is used to couple directly from the rectangular to the ridged waveguide. The probe is soldered to the centre of the ridge. This design is similar to that used by Mumford [4], except that his design couples to coaxial line. A reflection coefficient of less than 5 per cent is easily achieved within a 15-per-cent band at frequency  $f$ .

In the over-all filter (with a transition on each end) the screws 4 are used to give a final match at  $f_r$ , compensating for the excess reflections of the transition, slots 5, and screw 1.

Additional transitions are required to permit the use of conventional waveguide test gear for measurements at  $3f$ . Stepped ridged transitions [3] are used to connect the size-16 rectangular to size-16 ridged waveguide.

Using a single resonant screw 1 (Figure 3), a loss of 50 decibels may be achieved at 12 000 megahertz. If greater loss is required it may be obtained by adding an extra resonant screw 1' on the opposite side of the ridge, spaced by  $3\lambda_g/4$  from screw 1 to avoid proximity effects. Both screws are resonated together for a maximum transmission loss of the order of 90 decibels (see Figure 5). The losses shown

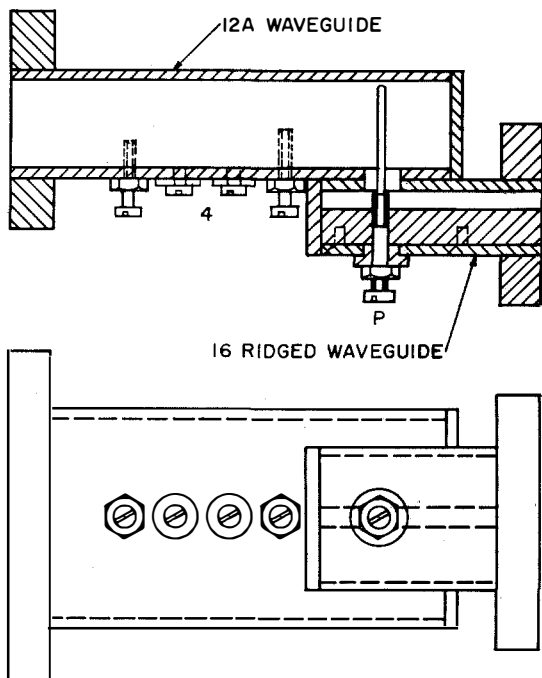

Figure 4—Transition between ridged and rectangular waveguides.

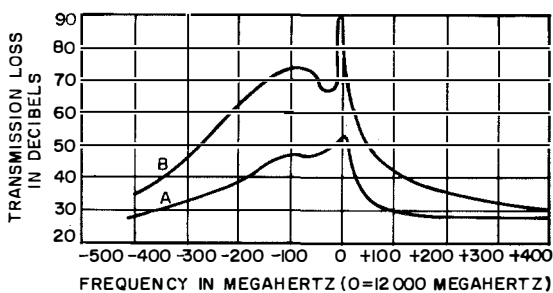

Figure 5—Transmission loss of absorption filter adjusted for maximum attenuation at 12 000 megahertz ( $3f$ ). Curve A is for ridged waveguide using screw 1 and curve B for ridged waveguide using screws 1 and 1'. The loss at 4000 megahertz (fundamental  $f$ ) was 0.15 decibel for the same filter, including probe losses.

are obtained using the size-16 waveguide transitions. As previously mentioned, there will be additional reflection loss when probe transitions from size 16 to size 12A are connected.

The loss of the composite filter at 4000 megahertz is 0.15 decibel. One filter assembly can be tuned to absorb any frequency in the band from 10 800 to 12 600 megahertz. The ridged-waveguide filter may be used for sum-frequency absorption if the input mixer is made in ridged waveguide.

A single ridged-to-rectangular waveguide transition would be used on the aerial side of the filter.

### 4. Comparison With Low-Pass Filters

If conventional low-pass filters are employed in coaxial lines, suppression is achieved by reflecting the energy. They work fine if the source and load are matched, but in many applications this is not the case. For example, when the third harmonic is to be absorbed in a waveguide system passing frequency  $f$ , spurious troughs occur in the stop-band characteristic that may be well below the desired stop-band loss. It is often difficult to guarantee that such a trough does not occur at the precise frequency ( $3f$ ) to be suppressed.

In addition, the coaxial low-pass filter must be made small in diameter to prevent further "holes" caused by waveguide modes. This results in higher attenuation at the pass-band frequency  $f$ .

These disadvantages are overcome by using the ridged-waveguide absorption filter.

### 5. Conclusions

The absorbing filters described are most suitable for use where specific super-high-frequency harmonics must be suppressed with negligible effect at the fundamental.

Their principal advantage is to guarantee a given suppression even between large mismatches in overmoded waveguide.

### 6. References

1. R. S. Caruthers, "Copper Oxide Modulators in Carrier Telephone Systems," *Bell System Technical Journal*, volume 18, number 2, pages 315-337; April 1939.
2. S. Hopfer, "Design of Ridged Waveguides," *I.R.E. Transactions on Microwave Theory and Techniques*, volume MTT-3, number 5, pages 20-29; October 1955.
3. E. S. Hensperger, "Broad-Band Stepped Transformers from Rectangular to Double-Ridged Waveguide," *I.R.E. Transactions on Microwave Theory and Techniques*, volume MTT-6, number 3, pages 311-314; 3 July 1958.
4. W. W. Mumford, "The Optimum Piston Position for Wide-Band Coaxial-to-Waveguide Transducers," *Proceedings of the I.R.E.*, volume 41, number 2, pages 256-261; February 1953.

**Joseph Paine** was born on 26 August 1916 in Oldham, England. In 1938, he received a B.Sc., Honours Physics, from Manchester University. In 1938, he joined Standard Telephones and Cables and was engaged in development work on multichannel carrier systems and test gear. Since 1950, he has worked on microwave radio links and is now in charge of design of waveguide components and aerials.

Mr. Paine is an Associate of the Institute of Physics.

**H. S. V. Reeves** was born in London on 3 September 1927. He received a B.Sc. in engineering, telecommunications, from London University in 1951.

He joined Standard Telephones and Cables in 1951, where he worked on the development of microwave radio links, and in 1961 moved to St. Mary Cray with the microwave engineering laboratory.

Mr. Reeves is an Associate Member of the Institution of Electrical Engineers.

# Evolution of Telephone, Telegraph, and Telex Traffic \*

E. M. DELORAINE

Laboratoire Central de Télécommunications; Paris, France

## 1. Introduction

The present and future status of telephone, telegraph, and telex world traffic, particularly intercontinental service, depends mainly on the decisions of government or private administrations responsible for operation of the telecommunication networks. We have therefore analyzed the information in our possession and complemented it, in several cases, by information kindly supplied by these organizations.

Administrations in charge of the telecommunication services must plan, often years in advance, network modifications and extensions to handle future traffic without protracted overloading of facilities. This long-range planning can prevent loss of revenue to the communication system and facilitate economic development of the country.

It is therefore vital to foresee the evolution of different forms of traffic in the next 10 or 20 years. This may be done by study of the demand, by comparison with related activities, or by extrapolation of the past evolution.

Study of the demand involves numerous technical, economic, and political factors. Telford and Isted [1] have compared the evolution in the United Kingdom of intercontinental telephone traffic with that of railroad and air traffic. By shifting the time scale, similarity appears in their evolution curves for periods of a few years. Extrapolation of this similarity must be done with caution, because the factors coming into play can occur at different times or have very-different effects.

Brinkley [2] presented in 1961 an estimate of the number and layout of the circuits necessary to handle the intercontinental traffic from Europe and the United States.

It is certain that each operating administration has used one or more of the preceding methods

to estimate future needs. These results generally are not known to us. In this paper, we study the past evolution of the different kinds of traffic and extract the maximum information to determine future evolution. In each case, we have extrapolated from the last 10 or 12 years of the evolution curve.

The first consequence of this method is that we neglect the stimulation of phenomena such as the introduction of wide-band transoceanic cables, future artificial satellites, and even new types of traffic, tariff reductions, and better service.

The extrapolation assumes that the expected evolution will correspond to the past evolution for the same phase of economic and social expansion. Economists distinguish 4 phases in the lifetime of a product; a rather-short first phase called the launching period, a second (development) phase with linear or exponential growth of variable duration, a third (nearly stationary) phase corresponding to saturation of the market, and a fourth phase of decline during which replacement products appear that are better adapted to the needs.

We shall see that telephone traffic is in the second phase and is likely to remain there for a long time. Telegraph traffic is in the third or fourth phase, while telex traffic is beginning the second phase.

## 2. Statistical Data

The available telecommunication data concern either the actual traffic, the number of telephone sets, or the number of circuits. The latter quantities depend directly on network extension, the technical solutions adopted, and the financial means used; furthermore, the circuits can have very-different rates of occupation and therefore the data concerning circuits are not accurate indexes of the evolution of telephone, telegraph, or telex traffic.

It is possible to obtain precise traffic data from most of the large operating organizations.

---

\* Prepared at the request of the International Institute of Communications and presented at its 11th meeting in Genoa, Italy, from 6 to 12 October 1963.

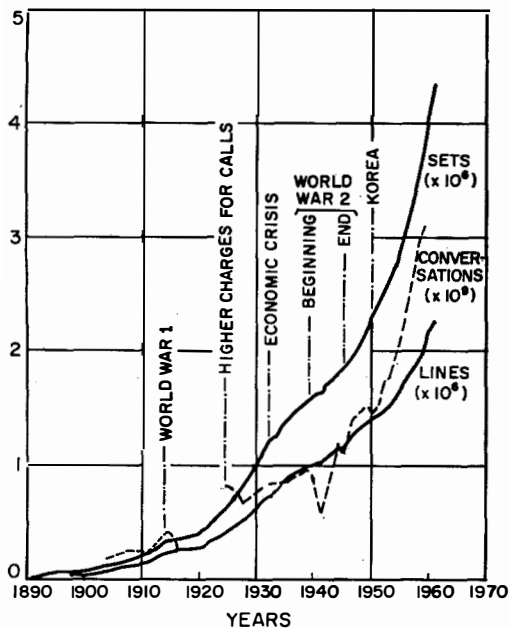

Figure 1—Telephone development in France [3].

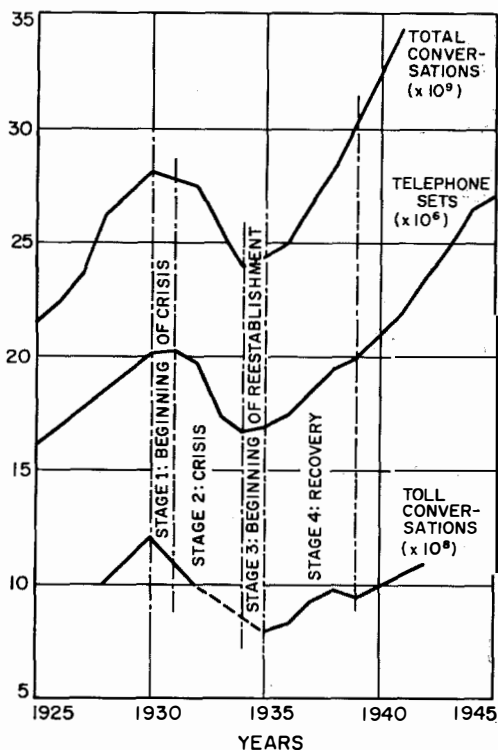

Figure 2—United States telephone sets and conversations during the economic depression of the 1930's [3].

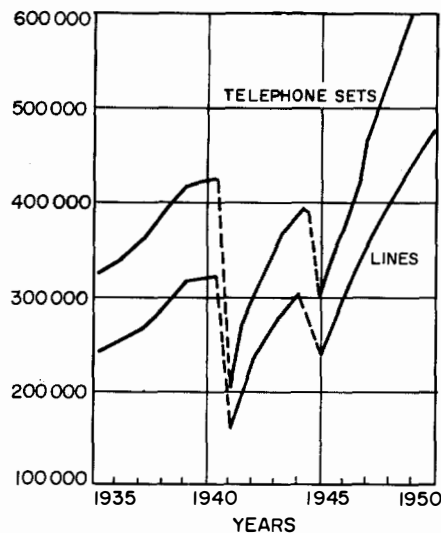

Figure 3—Effects of World War 2 on telephony in Belgium [3].

However, these data are difficult to group and interpret as a whole, because they are presented in different forms. For example, telephone data may consist of the number of conversations, communication units, charged minutes, or metered pulses. Telegraph data may consist of the number of messages or words, while telex data may include the number of messages, charged minutes, or metered pulses.

This study is limited to estimating the future growth rates of internal, international, and intercontinental traffic in the telephone, telegraph, and telex fields. We propose to determine average rates by category of traffic rather than by geographical distribution of circuits.

### 3. Phenomena Influencing Traffic Evolution

Numerous causes can influence the telecommunication development curves sufficiently to mask the normal growth for several years, during which any extrapolation would be meaningless. The causes of slackening and stimulation are of special concern. When the former stop exerting their influence, the evolution curves generally grow more rapidly, to catch up with

the normal development as if the cause had never existed. The result is a reversible effect. On the other hand, the causes of stimulation are almost-always followed by irreversible effects and therefore modify the character of the average evolution curve.

The most-important phenomena that can influence the evolution of traffic are the following.

(A) Economic. National or international economic crisis or an increase in price of communications or subscriptions causes an appreciable decrease in traffic, but the corresponding alteration of the average growth curve is generally momentary (see Figures 1 and 2).

(B) Political. Local and world conflicts entail a decrease in traffic for the duration of the con-

flict, followed by a rapid recovery to the normal evolution (see Figures 1 and 3).

(C) Meteorological. Evolution curves of the intercontinental telephone traffic show a marked decrease in the number of communications during periods of abnormal solar activity.

(D) Technical. An appreciable improvement in circuit quality generally results in an increase in traffic, plus an increase in the average duration of telephone communications. This was demonstrated after the introduction of transatlantic submarine telephone cables. Technical progress often permits cost reduction, especially when many circuits are grouped on the same facility. An example is the introduction of coaxial cables. Also, the number of calls is

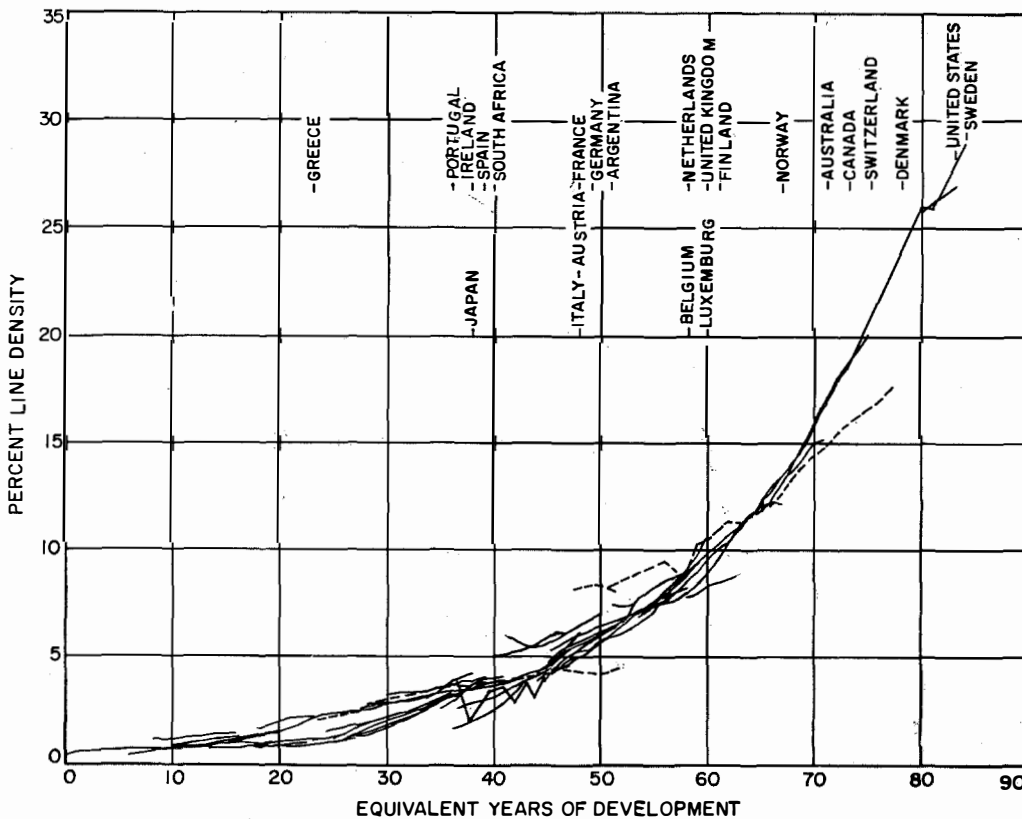

Figure 4--Composite line-density curves for various countries as a function of time in years  $t$  and a constant  $c$  of relative lag or lead with respect to all others. The development of each country is indicated as of 1 January 1961 [3].

## Telephone, Telegraph, and Telex Traffic

highly influenced when the called subscriber can be reached easily, for instance by direct dialing.

### 3.1 RECIPROCAL INFLUENCES

The rapid growth in telephone traffic and the relatively recent introduction of telex service have slowed the development of telegraph service until it is approximately stationary or declining everywhere.

We must also consider the influence of new forms of information exchange, particularly the

transmission of numerical data as a result of the increasing use of large computers and the use of wide frequency bands for intercontinental television transmission. This new traffic will probably have an exceptionally high growth rate if, as foreseen, the rapid exchanges of data entail great economic advantages.

### 4. Evolution of Telephone-Line Density

The evolution of telephone-line density (number of lines per 100 inhabitants) was studied by Bogaerts [3] for numerous countries. He shows that the density of a given country's telephone lines is approximately an exponential function of time. That is, the average annual increase of density is a constant, independent of time and applicable to all countries with one or two exceptions. This increase approximates 5 percent annually.

Figure 4 illustrates the conclusion of the Bogaerts study. By shifting the time scale, it is possible to superimpose the curves of different countries on a single exponential curve. This confirms that the annual increase of line density is constant for all countries.

This study raises the question whether, by analogy, the increase of international or intercontinental traffic follows an exponential law. We shall see that this hypothesis is amply verified.

### 5. Evolution of Telephone Traffic

To show the differences in growth among various categories of traffic, we have plotted evolution curves of the internal, international, continental, and intercontinental telephone traffic of the past 10 years for the United Kingdom, France, United States, West Germany, The Netherlands, and Italy.

#### 5.1. UNITED KINGDOM

Figure 5 shows the evolution of local, toll, continental, and intercontinental traffic in number of calls per year [4-6]. The influence of

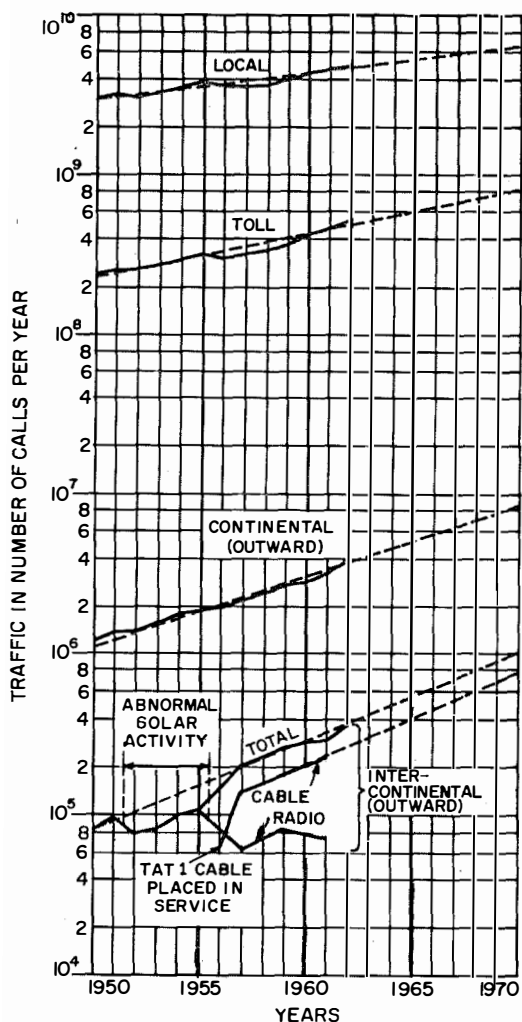

Figure 5—Evolution of telephone traffic in the United Kingdom.

sunspots from 1952 to 1955 is seen on the curve of intercontinental traffic, also the favorable effect from placing the transatlantic repeated cable *TAT 1* in service, an effect that partially overlaps the effect of the sunspots. Plotting traffic by cable and by radio links separately shows that the latter has decreased since 1955 to the benefit of the submarine cable.

Two conclusions can be drawn from examination of these curves.

(A) The curves plotted in semilogarithmic coordinates are approximately straight lines, which means that the increase in telephone traffic is exponential (annual growth rate is constant).

(B) The slope of the straight lines is steeper (annual growth rate is higher) when the destination of the traffic is farther away. Average annual growth rates are given in Table 1. The

Traffic	Growth Rate in Percent
Local	3.7
Toll	6.7
European International	10.3
Intercontinental	13
<i>TAT 1</i> Cable	13.6

fact that the curves can be assimilated to straight lines simplifies the extrapolation (broken lines for future development in Figure 5).

### 5.2 FRANCE

Figure 6 shows that telephone traffic is increasing faster in France than in the United Kingdom. This is explained by France's lag in telephone density (10 sets per 100 inhabitants against 16 sets per 100 inhabitants in the United Kingdom) and also by the fact that traffic is expressed in units of taxation, which involves distance and duration of the calls.

The internal traffic is expressed in metered pulses, the international traffic in 3-minute units of communication, and the traffic toward Algeria, the United States, and Canada in number of charged minutes. The use of metered pulses for both local and toll traffic prevents separating the number of calls for each service from the total.

The figures were taken from [7] and were completed by courtesy of the Direction Générale des Télécommunications. We again find—although less clearly for intercontinental traffic

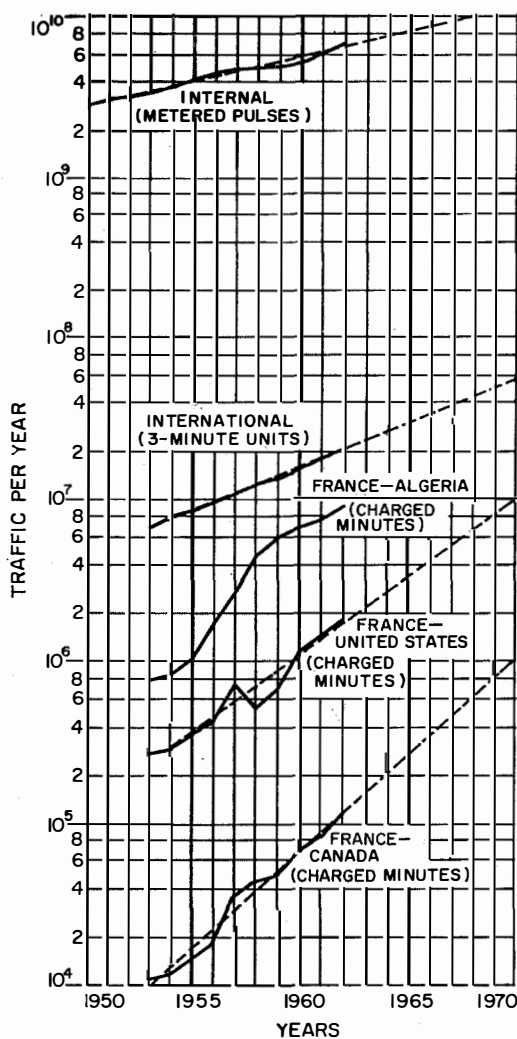

Figure 6—Evolution of telephone traffic in France.

## Telephone, Telegraph, and Telex Traffic

—approximately rectilinear graphs corresponding to an exponential growth.

The traffic between France and Algeria from 1955 through 1959 shows rapid growth because the Grasse-Bugeaud radio beam was placed in service in July 1956 and the Marseilles-Algiers submarine cable in December 1957. Slackening appears in following years for obvious political reasons and is not quite counterbalanced by placing in service the Perpignan-Oran cable in February 1962.

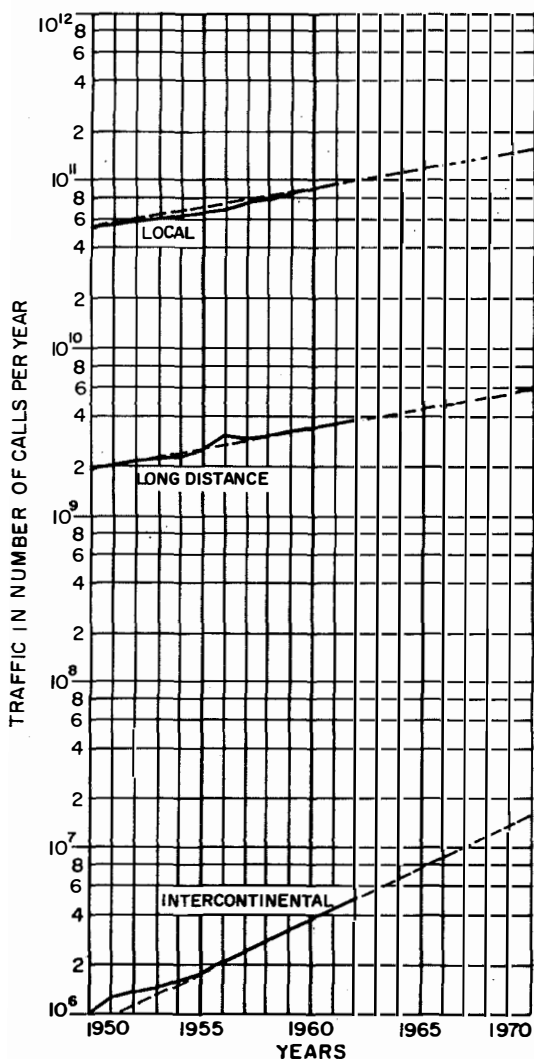

Figure 7—Evolution of telephone traffic in the United States.

On the curve of traffic between France and the United States, a sharp rise reflects cut-over of the TAT 2 cable in September 1959 and, 1 year later, equipment making it possible to double the number of conversations on this cable.

The average annual growth rates for the various categories of traffic are given in Table 2.

Traffic	Growth Rate in Percent
Internal	8.1
International-Continental	13.5
Intercontinental	20.6
France and United States	24.5
France and Canada	30.5

As in the United Kingdom, intercontinental traffic increases faster than international traffic, which increases faster than internal traffic.

### 5.3 UNITED STATES

Figure 7 illustrates the evolution of United States local, long-distance, and intercontinental traffic. The latter includes that between the United States and South America [1, 8, 9].

The curves are almost straight lines. Intercontinental traffic seems to increase more rapidly and more regularly since 1955. This corresponds to the end of the period of unfavorable solar activity and to the appearance of two transatlantic cables in 1956 and 1959.

Table 3 gives the average annual growth rates for the United States.

Table 4 gives the 1962 distribution of the 5 million intercontinental calls originating from or destined for the United States [10].

The intercontinental traffic of the United States, excepting that with Europe, represents about 50 percent of the world intercontinental traffic. Traffic between Western Europe and North



straight lines estimating the maximum and minimum increases.

Using this extrapolation method, Table 5 gives the foreseeable growth rates for internal, international, and intercontinental telephone traffic,

Traffic	Growth Rate in Percent
Local	5.3
Long Distance	5.5
Intercontinental	16.1

Area	Calls in Millions (Percent)
Alaska, Hawaii, Puerto Rico, and Virgin Islands	1.8 (36)
Europe	1.5 (30)
South America	1.4 (28)
Pacific	0.3 (6)

Traffic	Annual Growth Rate in Percent†	Growth Factor	
		10 Years†	20 Years†
Internal	4; 6; 9	1.4; 1.8; 2.5	2.1; 3.4; 6.2
International	10; 13; 19	2.6; 3.3; 5.9	6.6; 11; 35
Intercontinental	12; 17; 20	3.3; 4.6; 6	11; 21; 36

\* These growth rates should be compared with those given in [1], whose authors foresee an increase in intercontinental telephone traffic of 17 to 26 percent annually. In his testimony before the United States Federal Communications Commission, C. M. Mapes [8] estimates this growth rate at about 18 percent annually.  
† Minimum; average; maximum.

America represents about 25 percent of the world intercontinental traffic. Moreover, this corresponds very closely to the ratios of the telephone sets in the United States, Western Europe, and the rest of the world.

5.4 PROBABLE EVOLUTION

Figure 8 shows the evolution curves for internal, international, and intercontinental telephone traffic of the 6 countries studied, within the limits of information at our disposal and of that kindly provided by the Italian Post Office.

These curves were plotted in semilogarithmic coordinates and in arbitrary units. All traffic values have been divided by the corresponding 1961 values, to make the general extrapolation easier and to show the similarity of the growth rates.

We see that for a given category of traffic, growth is on the same order of magnitude for all the countries. We can therefore extrapolate a straight line giving the average increase in each category of traffic, a line sandwiched by 2

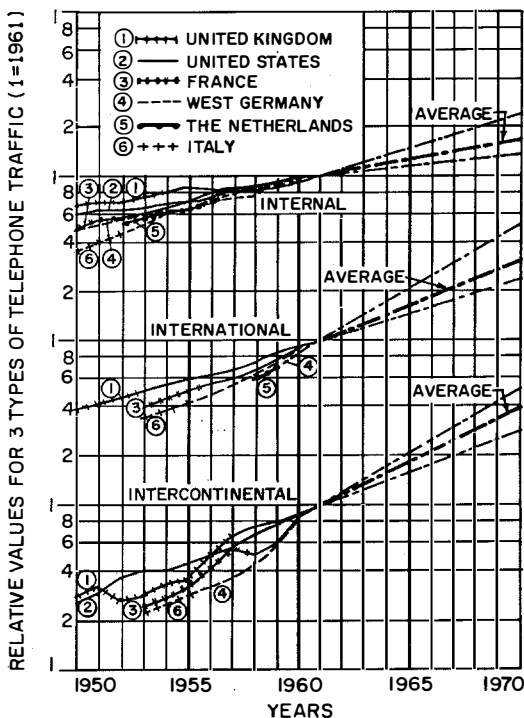

Figure 8—Evolution of telephone traffic for 6 selected countries. 1961 is the base year.

## Telephone, Telegraph, and Telex Traffic

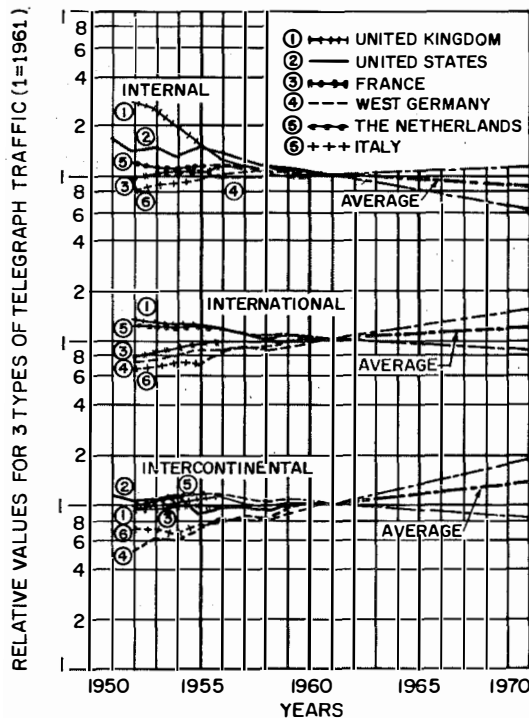

Figure 9—Evolution of telegraph traffic for 6 selected countries (excluding telex). 1961 is the base year.

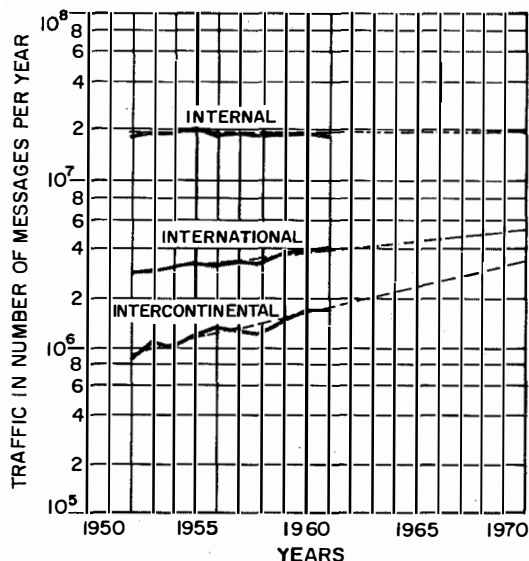

Figure 10—Evolution of telegraph traffic in West Germany.

plus the growth factors (ratio of future traffic to present traffic) for 10 and 20 years. We did not take into account the factors of stimulation already discussed.

### 6. Evolution of Telegraph Traffic

Even though telegraph traffic generally has shown no further increase for several years, there still remain numerous regions poorly served by telephone cables or telex circuits, where a significant increase in telegraph traffic is foreseen. Forecasts of the Comité Consultatif International Télégraphique et Téléphonique show an annual average increase for Asia of about 3 percent (between 2 and 6 percent).

Figure 9 shows the evolution curves for internal, international, and intercontinental telegraph traffic in semilogarithmic coordinates. All traffic values have been divided by the corresponding 1961 values to facilitate the comparison among the countries studied. The probable evolution through 1970 is also shown by extrapolation. Table 6 gives the foreseeable growth rates for internal, international, and intercontinental telegraph traffic, plus their 10-year growth factors.

The intercontinental traffic of the United States is nearly constant, while its internal traffic decreases by an average of 6 percent annually. United Kingdom traffic with Europe decreases by 3 percent annually. In France and The Netherlands, traffic is approximately stationary, but in Germany, where telephone traffic is increasing very rapidly, international tele-

TABLE 6  
TELEGRAPH GROWTH RATES AND GROWTH FACTORS  
FOR THE 6 COUNTRIES IN FIGURE 9

Traffic	Annual Growth Rate in Percent*	10-Year Growth Factor*
Internal	-5; -2; +1	0.6; 0.8; 1.1
International	-1; +2; +4	0.8; 1.2; 1.5
Intercontinental	-1; +3.5; +6	0.9; 1.4; 1.8

\* Minimum; average; maximum.

graph traffic increases by 4 percent annually and intercontinental traffic by more than 7 percent. In Italy, international telegraph traffic increases by 5 percent annually and intercontinental traffic by 4.5 percent.

Figures 10 and 11, respectively, show the evolution of telegraph traffic since 1952 for West Germany and Italy [11], plus extrapolations of the curves through 1970.

We can conclude from these figures that telegraph traffic is generally declining or stationary except for countries in a period of great expansion or having poorly developed telecommunications. In the latter case, telegraph traffic should continue to increase for a long time.

### 7. Evolution of Telex Traffic

The evolution of telex traffic is less certain than that of telephone or telegraph traffic, because telex networks, particularly intercontinental ones, are relatively recent. Figure 12 shows the evolution of international telex traffic for the United States and several countries in Europe [12].

Most of the curves for European countries, which are approximately parallel, exhibit a striking "knee" toward 1955. Before this bend occurs, the curve is not rectilinear and the growth rate is very high (averaging 50 percent annually). It is only after 1955 that the curves can be assimilated to straight lines, with an annual growth rate on the order of 20 percent. Therefore, international telex traffic changes from the first phase of expansion to the second phase about 1955. This phenomenon is even clearer on the curve in Figure 12 for the total international telex traffic of the 12 countries under consideration.

This modification of the growth rate is one of the hazards of forecasting by extrapolation from past evolution. Thus for intercontinental telex traffic, whose development is more recent than that of international traffic, it is quite possible that today's very-high growth rate will decrease in coming years.

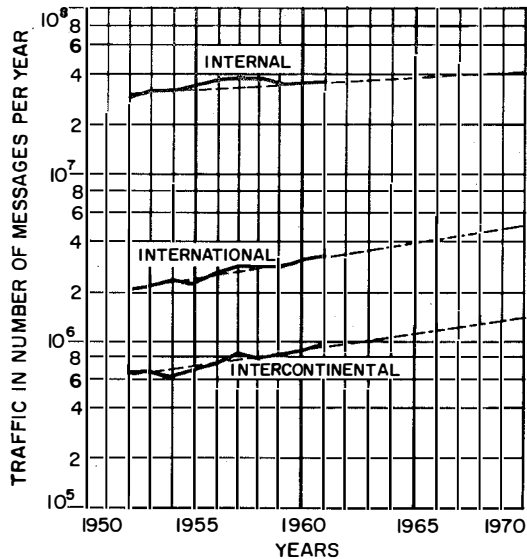

Figure 11—Evolution of telegraph traffic in Italy.

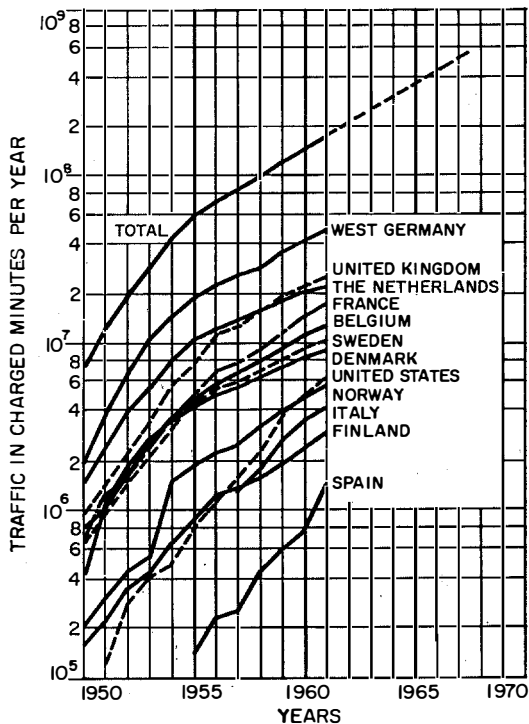

Figure 12—Evolution of international telex traffic.

## Telephone, Telegraph, and Telex Traffic

Figures 13 and 14, respectively, show the evolution of telex traffic for West Germany and Italy. The statistics for West Germany have been collected from [4], where comparable information for several other countries can be found. The statistics for Italy were kindly supplied by the Italian Post Office.

Figure 15 shows the evolution curves for internal, international, and intercontinental telex traffic of 6 countries. Traffic values for 1961 were used as before to facilitate comparison. The growth is still of the exponential type since the curves can be assimilated to straight lines in most cases.

Table 7 gives the foreseeable growth rates for internal, international, and intercontinental telex traffic, plus their 10-year growth factors.

### 8. Conclusions

The growth of telephone and telex traffic follows an exponential law with no indication of

Traffic	Annual Growth Rate in Percent*	10-Year Growth Factor*
Internal	7; 11; 20	2; 3; 6
International	15; 20; 27	4; 6; 10
Intercontinental	29; 35; 46	13; 21; 45

\* Minimum; average; maximum.

a beginning of saturation. Their rates of average annual increase are therefore constant and high, being higher for international and intercontinental traffic than for internal traffic.

The average growth rates are between 6 and 17 percent for telephone traffic. This gives an expectancy of doubled or quadrupled traffic in 10 years.

The corresponding values for telex traffic are between 11 and 35 percent. The corresponding

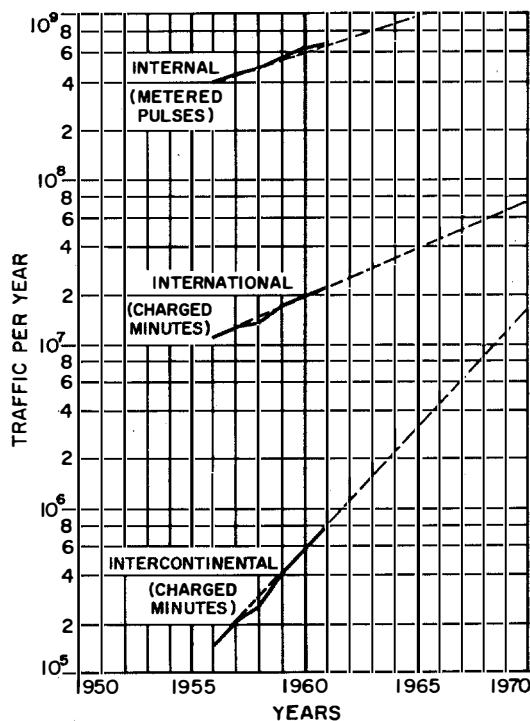

Figure 13—Evolution of telex traffic in West Germany.

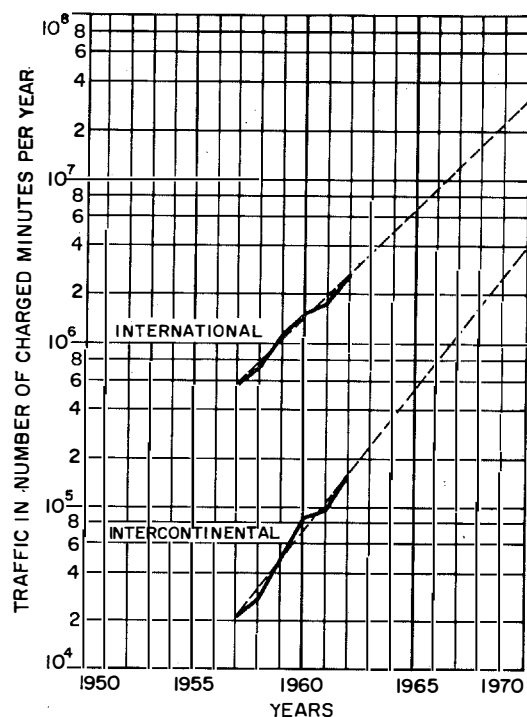

Figure 14—Evolution of telex traffic in Italy.

growth expectancy in 10 years is between 3 and 20 times the present traffic.

For telephone and telex traffic, this evolution has been vividly described by E. Laird as having an explosive character [10].

Figure 16 summarizes in different form the probable evolution of telephone, telegraph, and telex traffic. It shows the average growth rates (heavy horizontal lines) as well as the estimated uncertainties (shaded areas) for internal, international, and intercontinental traffic.

It is certain that the operating administrations and equipment manufacturers would benefit by anticipating the cumulative effect of the traffic densities that must be handled. Their plans must be made accordingly to avoid periods in which a lack of facilities would cause deterioration in the quality of service and a loss of revenue.

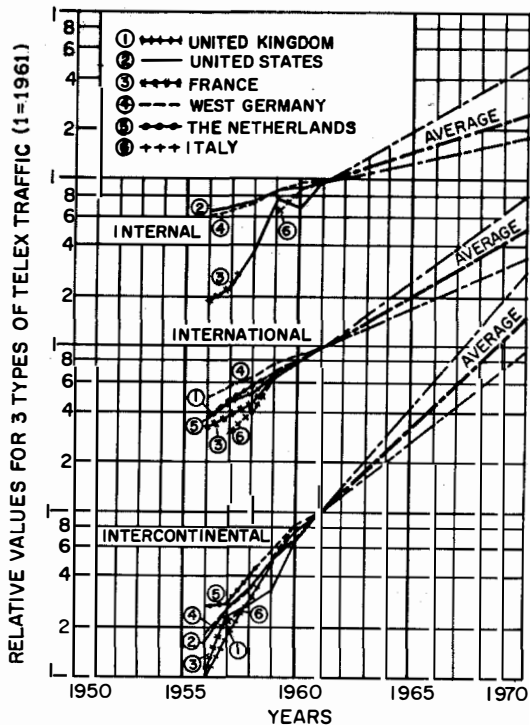

Figure 15—Evolution of telex traffic for 6 selected countries. 1961 is the base year.

### 9. Acknowledgments

I wish to thank the operating administrations and private companies for supplying me with information. Mr. Grandjean, Engineer of the Laboratoire Central de Télécommunications, also contributed substantially to the preparation of this document.

### 10. References

1. M. Telford and G. A. Isted, "Predicted Future Expansion of Intercontinental Telephone Traffic," *Point to Point Telecommunications*, volume 6, number 1, pages 4-31; October 1961.
2. J. R. Brinkley, "Economic Aspects of Space Communications," presented at the International Scientific Radio Union (URSI) in Paris; September 1961.
3. R. F. Bogaerts, "Probable Evolution of Telephony," *Electrical Communication*, volume 38, number 2, pages 184-195; 1963.

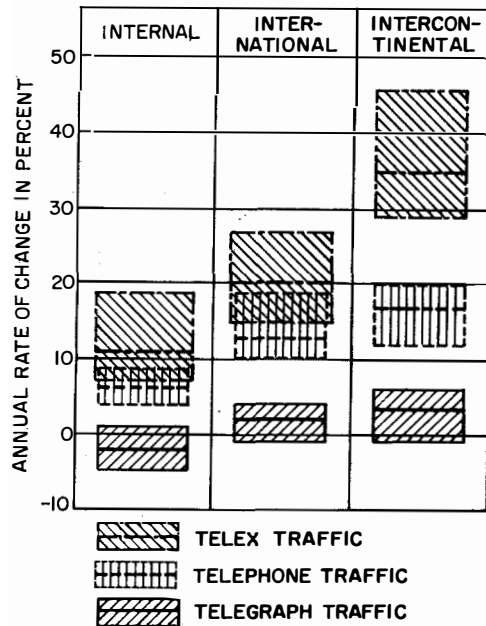

Figure 16—Summary of the average annual growth rates of telephone, telegraph, and telex traffic. The heavy lines are the levels of average expectancy drawn between the limits of estimated uncertainties.

## Telephone, Telegraph, and Telex Traffic

4. "Statistique Générale de la Téléphonie." In the annual publication of L'Union Internationale des Télécommunications, Geneva; 1952 to 1961.
5. Post Office Telecommunication Statistics, London; March 1962.
6. "Post Office Report and Accounts." Her Majesty's Stationery Office, London; 1952 to 1961.
7. Statistique Annuelle du Service des Télécommunications au Ministère des Postes Télégraphes et Téléphones de France; 1962.
8. C. M. Mapes (American Telephone and Telegraph Company). Testimony before the Federal Communications Commission, Docket 11 866; 1960.
9. "The World's Telephones." American Telephone and Telegraph Company, New York; 1952 to 1961.
10. E. Laird. Presentation before the French section of the Institute of Electrical and Electronics Engineers, Paris; 2 July 1963.
11. "Statistique Générale de la Télégraphie." In the annual publication of L'Union Internationale des Télécommunications, Geneva; 1952 to 1961.
12. "Le Développement du Service Télex International." In the annual publication of L'Union Internationale des Télécommunications, Geneva; 1956 to 1961.

**E. M. Deloraine** was born in Paris, France, on 16 May 1898. He received in 1918 the B. S. degree, the Certificat de Mathématiques, and in 1920 the engineering diploma of the École Supérieure de Physique et Chimie, a branch of Paris University. In 1949, he was granted the degree of Docteur-Ingénieur by Paris University.

In 1917, he joined the French Army Signal Corps and later engaged in research work at the Eiffel Tower. He became a member of the London engineering staff of the International Western Electric Company in 1921, where he worked on radio broadcast transmitters and was responsible for part of the development in Great Britain of the first radio transatlantic telephone circuit.

In 1928, he organized the International Standard Electric Corporation Paris laboratory that became Laboratoire Central de Télécommunications. He was made European Technical Director of that corporation in 1933. From 1931 to 1937, he contributed importantly to the application of ultra-high frequencies to communication. He was also active in the advancement of high-power broadcasting.

Dr. Deloraine came to the United States in 1941 to establish a laboratory for defense work

for Federal Telephone and Radio Corporation. In 1946, he was appointed General Technical Director of International Telephone and Telegraph Corporation, Vice-President and Technical Director of the International Standard Electric Corporation, and Vice-Chairman of Standard Telecommunication Laboratories in Great Britain. In this period, he was personally active in research and development of switching systems. Later, he was appointed and still serves as Vice-President of International Standard Electric Corporation, President of the Laboratoire Central de Télécommunications, and President of Le Matériel Téléphonique.

Dr. Deloraine was made a Chevalier of the Legion of Honor in 1938 for exceptional services to the Posts and Telegraphs Department of France, and in 1945 was promoted to Officer of the Legion of Honor by the Minister of the Navy. In 1963, he was made an Officer of Postal Merit by the Minister of Postes et Télécommunications.

Dr. Deloraine is a Fellow of the Institute of Electrical and Electronics Engineers and a Member of the Institution of Electrical Engineers in Great Britain. He also holds membership in several scientific societies in France.

# Spectral Matrix for Analysis of Time-Varying Networks

CARL KURTH

Standard Elektrik Lorenz AG; Stuttgart, Germany

## 1. Introduction

The analysis of networks with constant  $R$ ,  $L$ , and  $C$  elements has produced standard results during the past decade so that the developed theory may be considered established. Lately, networks with time-varying or controlled  $R$ ,  $L$ , and  $C$  elements have been gaining in importance, and mathematical analysis of them is in the forefront of technological interest.

Thus far, there is no systematic theory for the behavior and properties of such networks. The existing technical literature indicates that they are more versatile than networks made up of constant elements. This is not only of mathematical interest in that the function types realizable by networks are expanded, but networks with time-varying elements are already finding many applications in practical engineering. Well-known examples are rectifier modulators, parametric amplifiers, and reactance modulators.

The many properties such networks may have are not always immediately apparent, both in time and frequency, because the time function of the control parameter constitutes an additional variable and the output response generally corresponds to the input signal by linear differential equations of high order and with periodic coefficients. During past years, papers on this subject have been published by Zadeh, Darlington, Kinarawala, Taft, Wunsch, and others [1-8]. Zadeh [2] presents a detailed bibliography. All these papers indicate that a very-large volume of numerical calculations is required, particularly in the time domain with consideration of the transient processes during on-switching. In many cases, only the steady state is of interest, and then it is desirable to bypass the differential equations by using a method similar to that applied for time-invariant networks.

## 2. Time-Varying Elements and Four-Poles

Let us assume that the controlled elements are influenced solely by the control function and

not by the signal. The circuits may then be considered quasi-linear networks and the input voltage is determined in accordance with the superposition theorem. The mathematical expression for a time-varying element then is

$$R = R(t).$$

The time function  $R(t)$  may be either impulsive or periodic. In the latter case, it can be expressed by a Fourier spectrum. The instantaneous value of voltage drop is given by Ohm's Law as

$$u = iR(t). \quad (1)$$

For inductances, it follows that

$$u = \frac{dL(t)i}{dt} = L(t) \frac{di}{dt} + i \frac{dL(t)}{dt} \quad (2)$$

where  $L(t)$  is a controlled inductance. Similarly,  $q = uC(t)$  applies for capacitors

$$i = \frac{dq}{dt} = \frac{dC(t)u}{dt} = C(t) \frac{du}{dt} + u \frac{dC(t)}{dt} \quad (3)$$

$C(t)$  being a controlled capacitor.

Using (1), (2), and (3), the mesh or nodal equations can be written in differential form for circuits made up of both variable and constant elements. The solution is then generally obtained by a linear differential equation of the  $n$ th order with periodic coefficients,  $u_2(t)$  denoting the unknown output voltage between two nodes and  $u_0(t)$  the input voltage between any other two nodes [1]. The differential equation is

$$\begin{aligned} \frac{d^n u_2}{dt^n} + P_{n-1}(t) \frac{d^{n-1} u_2}{dt^{n-1}} + \dots \\ + P_1(t) \frac{du_2}{dt} + P_0(t) u_2 \\ = Q_0(t) + Q_1(t) \frac{du_0}{dt} + \dots \\ + Q_m \frac{d^m u_0}{dt^m}. \quad (4) \end{aligned}$$

If the coefficients  $P_i(t)$  are periodic [7, 9], we obtain as the solution for  $u_2(t)$  an infinite sum of periodic functions. The differential equation

is easy to write if the circuits are ladder networks having only one element at every branch, as are often used in practice. The cascade equations for the instantaneous values can then be written in differential form.

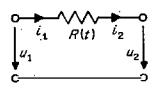

$$\begin{aligned} u_1 &= u_2 + i_2 R(t) \\ i_1 &= 0 + i_2 \end{aligned} \quad (5)$$

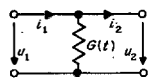

$$\begin{aligned} u_1 &= u_2 + 0 \\ i_1 &= u_2 G(t) + i_2 \end{aligned} \quad (6)$$

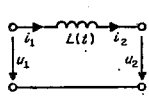

$$\begin{aligned} u_1 &= u_2 + \frac{dL(t)i_2}{dt} \\ i_1 &= 0 + i_2 \end{aligned} \quad (7)$$

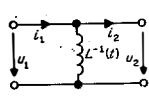

$$\begin{aligned} u_1 &= u_2 + 0 \\ i_1 &= L^{-1}(t) \int_0^t u_2 dt + i_2 \end{aligned} \quad (8)$$

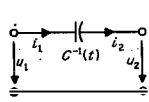

$$\begin{aligned} u_1 &= u_2 + C^{-1}(t) \int_0^t i_2 dt \\ i_1 &= 0 + i_2 \end{aligned} \quad (9)$$

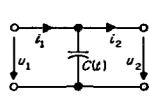

$$\begin{aligned} u_1 &= u_2 + 0 \\ i_1 &= \frac{dC(t)u_2}{dt} + i_2. \end{aligned} \quad (10)$$

The four-poles expressed by (5) through (10) are the fundamental circuits with which any type of network without coupling coils can be designed. It is easy to cascade such four-poles in differential form by simply entering the input values of one four-pole as the output values of the preceding four-pole. Figure 1 shows an example of this, with

$$\begin{aligned} u_1 &= u_2 + C^{-1}(t) \int_0^t i_2 dt \\ u_2 &= u_3 + 0 \\ i_1 &= 0 + i_2 \end{aligned}$$

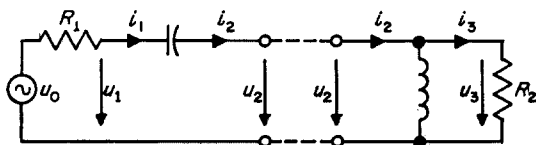

Figure 1—Cascade of 2 time-varying four-poles.

$$\begin{aligned} i_2 &= L^{-1}(t) \int_0^t u_2 dt + i_3 \\ u_1 &= u_3 C^{-1}(t) \int_0^t \left[ L^{-1}(t) \int_0^t u_3 dt \right] dt \\ &\quad + C^{-1}(t) \int_0^t i_3 dt \\ i_1 &= L^{-1}(t) \int_0^t u_3 dt + i_3. \end{aligned} \quad (11)$$

Using  $p$  as operator in  $di/dt = pi$  or  $\int_0^t idt = \frac{1}{p}i$ , equation (11) is obtained by multiplication of the matrixes. The factorizing sequence in the individual matrix elements is not changeable; however

$$\begin{aligned} u_1 &= u_3 + C^{-1}(t) \frac{1}{p} \left[ L^{-1}(t) \frac{1}{p} u_3 \right] \\ &\quad + C^{-1}(t) \frac{1}{p} i_3 \\ i_3 &= L^{-1}(t) \frac{1}{p} u_3 + i_3 \end{aligned} \quad (12)$$

or

$$\begin{aligned} \begin{bmatrix} u_1 \\ i_1 \end{bmatrix} &= \begin{bmatrix} 1 & C^{-1}(t) \frac{1}{p} \\ 0 & 1 \end{bmatrix} \begin{bmatrix} 1 & 0 \\ L^{-1}(t) \frac{1}{p} & 1 \end{bmatrix} \begin{bmatrix} u_3 \\ i_3 \end{bmatrix} \\ &= \begin{bmatrix} 1 + C^{-1}(t) \frac{1}{p} L^{-1}(t) \frac{1}{p} & C^{-1}(t) \frac{1}{p} \\ L^{-1}(t) \frac{1}{p} & 1 \end{bmatrix} \begin{bmatrix} u_3 \\ i_3 \end{bmatrix}. \end{aligned}$$

With the relations  $i_3 = u_3/R_2$  and  $i_1 R_1 = u_0 - u_1$  in Figure 1, the differential transfer function for this example is

$$\begin{aligned} u_0 &= u_3 \left( 1 + \frac{R_1}{R_2} \right) \\ &\quad + \left[ RL^{-1}(t) + \frac{C^{-1}(t)}{R_2} \right] \int_0^t u_3 dt \\ &\quad + C^{-1}(t) \int_0^t \left[ L^{-1}(t) \int_0^t u_3 dt \right] dt. \end{aligned} \quad (13)$$

With  $u_0$ ,  $L^{-1}(t)$  and  $C^{-1}(t)$  given as periodic functions, it is possible to find a particular integral for the steady-state condition of  $u_3$ .



Similarly,  $u_0$  can be calculated for a prescribed  $u_3$ . In the special case of  $L^{-1}(t)$  and  $C^{-1}(t)$  corresponding to the same control function  $A(t)$ , a solution for  $A(t)$  can be found with a given  $u_0(t)$  and  $u_3(t)$ . As can easily be verified by reducing (13) to (4), the relation between  $u_0$  and  $u_3$  will always be a linear differential equation. When calculating the time function  $A(t)$  of the controlled elements for prescribed  $u_0(t)$  and  $u_3(t)$ , however, we will obtain nonlinear differential equations already having periodic coefficients for two controlled elements. Thus we will meet with difficulties when solving equations of a higher order. Of course, it is also possible that the system elements are wanted for a prescribed relation between input and output voltage. This would constitute a synthesis. We must distinguish among the 4 cases shown in Table 1.

TABLE 1  
SOLUTIONS FOR UNKNOWN

System Elements	Input Function	Control Function	Output Function	Solution
Given	Given	Given	Unknown	Linear differential equation
Given	Unknown	Given	Given	Point-by-point calculation
Given	Given	Unknown	Given	Nonlinear differential equation
Unknown	Given	Given	Given	Systematic unknown

In the general case, the infinite number of unknown spectral voltages must be calculated for the steady state from a linear system with an infinite number of equations. The results then denote the selective transmission functions for every  $p = j\omega$  from point to point. For extensive networks with more than one controlled element, calculations may become very difficult. Other selective functions, for example the input impedance, are even harder to calculate. When determining the element values for circuits having a prescribed frequency or time response, difficulties increase still further. The analysis of prescribed time-varying networks thus requires great mathe-

matical and numerical efforts, but even-greater efforts are required to determine the circuit structure of networks with given time or frequency functions. We shall attempt here to reduce the time and frequency relations to a synthesis similar to the network theory for circuits consisting of time-invariant elements.

### 3. General Solution with Differential Equation

It is assumed in the following that the time-varying elements  $R(t)$ ,  $L(t)$ , and  $C(t)$  of a network can be expressed by a Fourier series with the period  $T = 1/\Omega$ . As input and output are related to each other by a linear differential equation, harmonics of the input frequency  $\omega$  are excluded. All additive combinations between  $\omega$  and the harmonics of  $\Omega$  are possible, however. With more than one period, for example  $T_1 = 1/\Omega_1$ , and  $T_2 = 1/\Omega_2$ , in one controlled element, or with several controlled elements of different periods in one network, the frequency spectrum of currents or voltages will include the combinations of the harmonics of each period, for instance  $\Omega_{1n} \pm \Omega_{2m} \pm \omega$  ( $n$  and  $m$  are positive integers).

Consideration of only one period, therefore, is not disadvantageous for general mathematical discussion. In the case of more than one control function, for example

$$A_n(t) = \sum_{n=0}^{\infty} A_n \cos(n\Omega_1 t + \varphi_n)$$

and

$$A_m(t) = \sum_{m=0}^{\infty} A_m \cos(m\Omega_2 t + \varphi_m)$$

and a fixed input signal voltage  $E = u_0 \cos \omega t$  in a mesh, a linear differential equation of the  $n$ th order and with periodic coefficients (of the form similar to (4), for example) must be solved. The periodic coefficients may be expressed by  $A_n(t)$  and  $A_m(t)$ . A solution of the differential equation entails the solution of the homogeneous differential equation as well as of a

particular integral. It generally consists of the sum of an infinite number of transcendental individual functions. If the system is stable, the stationary condition of forced oscillations must enter into the sum of the infinite number of sinusoidal oscillations of constant amplitude; if unstable, one or more sinusoidal oscillations may appear with a continuously expanding amplitude.

In view of the linearity of the system, these expanding steady-state oscillations are—in theory—further superposed by injected forced oscillations. (This, of course, does not happen in practice because the system becomes non-linear at some point, and system constants change and set a limit for the expanding oscillations.) To solve (4) it may be assumed that in realistic cases the coefficients  $P_i(t)$  and  $Q_v(t)$  will be positive continuous functions for a positive  $t$ . In (4), conjugated complex  $u_2$  on the left-hand side will then be associated with conjugated complex  $u_0$  on the right-hand side. With

$$u_0 = |u_0| \cos \omega t = \frac{u_0}{2} e^{j\omega t} + \frac{u_0^*}{2} e^{-j\omega t}$$

assumed as input voltage, the particular solution for steady-state condition is

$$u_2(t) = \sum_{s=-\infty}^{\infty} |u_s| \cos [(\omega + s\Omega)t + \varphi_s] \quad (14)$$

$$\begin{bmatrix} u_0 & K_0 & e^{j\omega t} \\ u_{1-} & K_{1-} & e^{j(\omega-\Omega)t} \\ u_{1+} & K_{1+} & e^{j(\omega+\Omega)t} \\ u_{2-} & K_{2-} & e^{j(\omega-2\Omega)t} \\ u_{2+} & K_{2+} & e^{j(\omega+2\Omega)t} \\ \cdot & & \\ \cdot & & \\ \cdot & & \end{bmatrix} = \begin{bmatrix} e^{j\omega t} & 0 & 0 & 0 & 0 & 0 & \dots \\ 0 & e^{j(\omega-\Omega)t} & 0 & 0 & 0 & 0 & \dots \\ 0 & 0 & e^{j(\omega+\Omega)t} & 0 & 0 & 0 & \dots \\ 0 & 0 & 0 & e^{j(\omega-2\Omega)t} & 0 & 0 & \dots \\ 0 & 0 & 0 & 0 & e^{j(\omega+2\Omega)t} & 0 & \dots \\ \cdot & \cdot & \cdot & \cdot & \cdot & \cdot & \\ \cdot & \cdot & \cdot & \cdot & \cdot & \cdot & \\ \cdot & \cdot & \cdot & \cdot & \cdot & \cdot & \end{bmatrix}$$

or

$$u_2(t) = \sum_{s=-\infty}^{\infty} u_s \frac{e^{j(\omega+s\Omega)t}}{2} + \sum_{s=-\infty}^{\infty} u_s^* \frac{e^{-j(\omega+s\Omega)t}}{2} \quad (15)$$

The coefficients of the differential equation (4) may be written as a Fourier series

$$P_i(t) = \sum_{s=-\infty}^{\infty} P_{is} \cos (s\Omega t + \varphi_{is}) \quad (16)$$

or

$$Q_v(t) = \sum_{s=-\infty}^{\infty} Q_{vs} \cos (s\Omega t + \varphi_{vs}) \quad (17)$$

when calculating, as assumed earlier, with a period  $T = 1/\Omega$ .

By introducing this relation into (4), we obtain for the unknowns  $u_s$  and  $u_s^*$  a system consisting of an infinite number of equations and unknowns. Since the conjugated complex values appear also as unknowns, we can reduce the total number of unknowns by half. This is possible because the above properties of the differential equation apply to both complex and conjugated complex values of  $u_s$  and  $u_0$ . After grouping by positive  $j\omega$  in the argument, this system of equations yields a matrix (due to input of  $u_0 = K_0 e^{j\omega t}$ , all  $u_{s\pm} = 0$  except for  $s = 0$ ).

$$\begin{bmatrix} S_{00} & S_{01-} & S_{01+} & \dots \\ S_{1-0} & S_{1-1-} & S_{1-1+} & \dots \\ S_{1+0} & S_{1+1-} & \cdot & \dots \\ \cdot & \cdot & \cdot & \cdot \\ \cdot & \cdot & S_{vz} & \cdot \\ \cdot & \cdot & \cdot & \cdot \end{bmatrix} \begin{bmatrix} u_0 \\ u_{1-} \\ u_{1+} \\ u_{2-} \\ \cdot \\ \cdot \end{bmatrix} \quad (18)$$

The time functions in this system of equations may be cancelled and the complex  $\mathfrak{U}_s$  can be calculated approximately after stopping the infinite system at a finite number of equations. The larger the number of equations used, the greater will be the accuracy—but so will the numerical effort. With an increasing number of equations, moreover, the accurate value is approached only asymptotically. The calculation of the transmission function in stationary condition—and only thereof—would thus be reduced to the frequency domain.

The coefficients  $S_{vx}$  and  $K_{s\pm}$  in the matrix ( $S_{vx}$ ) of (18) are rational functions of  $j\omega$ . They generally represent complex figures that can be derived from the fixed values of the  $R$ ,  $L$ , and  $C$  elements of the networks and the coefficients  $P_{is}$  or  $Q_{vs}$ , respectively, of the control function. The integral of the homogeneous differential equation (4) may be determined with the same expression (15) for  $u_0 = 0$  (the freely oscillating condition). By introducing into (18)  $\mathfrak{U}_{s\pm} = 0$ , a homogeneous system with an infinite number of equations and unknowns is obtained. Only when the determinant of the system approaches zero will these unknowns differ from the trivial solution zero. Every matrix element is in this case a rational function of  $j\omega = p$  of a degree corresponding to the number of reactances contained in the system. The determinant  $|S_{vx}|$  of the system, however, must always have the degree infinity, independent of the degrees of the individual elements, for the number of elements is infinite and the product of an infinite number of elements is contained infinitely often in the determinant  $|S_{vx}|$ . Theoretically, there must be an infinite number of eigenvalues in  $p$ , given by the condition

$$D(p_i) = |S_{vx}(p_i)| = 0. \quad (19)$$

The homogeneous solution of (4) would then be the sum of all  $u_2(p, t)$  from (15)

$$u_2(t) = \sum_{i=1}^{\infty} u_2(p_i, t), \quad (u_0 = 0) \quad (20)$$

consisting of an infinite number of individual oscillations.

Only the  $\mathfrak{U}_{s_i}$  are still to be determined now. These unknowns may be derived from the equation system according to Cramer's rule. For the homogeneous case, however, it appears more advantageous to apply the Gaussian algorithm, as the uncertainty for the points  $|S_{vx}(p_i)| = 0$  can then be explained. Let us define the determinant  $D_s$  as that right-hand side obtained after application of the Gaussian algorithm for the unknown  $\mathfrak{U}_s$  by substituting the corresponding column of the system determinant  $|S_{vx}|$  through the left column of the equation system (18). We thus find the relation

$$|S_{vx}| \mathfrak{U}_s = D_s(p).$$

As is obvious from (18),  $u_0$  must be contained as a constant factor in every  $D_s(p)$ . We can thus substitute  $D_s(p) = u_0 D_s'(p)$  for  $D_s(p)$ .  $D_s'$  must further contain the eigenvalues of  $D_s$  in  $p$ . The following equation

$$|S_{vx}(p)| \mathfrak{U}_s = u_0 D_s'(p) \quad (21)$$

therefore, must be valid for all values of  $p$ , that is, also for the eigenvalues of  $|S_{vx}(p)|$ . Equation (21) can be satisfied in two different ways for  $p_i$ .

(A) If  $D_s'(p)$  also has an eigenvalue at  $p_i$ , it can cancel with that of  $|S_{vx}(p_i)|$ , and the unknown  $\mathfrak{U}_{s_i}$  will become zero for  $u_0 = 0$ . Physically, this means that the spectral lines  $\mathfrak{U}_{s_i}$  will not appear in the case of free oscillation.

(B) If  $|S_{vx}|$  and  $|D_s(p)|$  have no common divisors and thus do not have common eigenvalues, the equation is satisfied through a transition to the boundary  $p \rightarrow p_i$  for an eigenvalue  $p_i$  in  $|S_{vx}(p)|$  with  $u_0 = 0$ .  $\mathfrak{U}_{s_i}$  then assumes a finite value that can be determined from (21) after omitting the linear factor  $(p - p_i)$  of the corresponding eigenvalue on the left-hand side and  $u_0$  on the right-hand side. The conventional expression

## Spectral Matrix for Time-Varying Networks

thus is

$$u_{s_i} = \frac{D_s'(p_i)}{d|S_{vx}(p_i)|} \quad (22)$$

It is valid for both cases. This simultaneously meets the limit-value condition of (4) that all  $u_i$  must be zero at  $t = 0$ . Taft [7] stated that the number of free oscillations (except periodic harmonics of the control frequency) is equal to the number of free oscillations of the same network made up of time-invariant elements. These frequencies of free oscillations would satisfy (21) by the second method and all the others by the first method. This is also known from Hill's differential-equation theory [9]. It should be noted that in this case, too, the real components of  $p_i$  indicate the stability of the system. Positive real components lead to constantly rising spectral lines, as is obvious when introducing them into (15); it would mean instability. The system is stable if real components of  $p_i$  with negative sign only are present.

### 4. Analysis of Stationary Condition in Frequency Domain

In the following, a method is discussed that permits us to define primarily the stationary condition of forced oscillations without having knowledge of the differential equation. Obviously, this method is particularly suitable for numerical evaluation with the aid of digital computers. Let us assume that all spectral frequencies possible according to (15) can be present in the currents and voltages of every four-pole or branch. The spectrum of input parameters, therefore, is expressed by  $p = j\omega$

$$u = \sum_{s=-\infty}^{\infty} u_s e^{(p+j_s\Omega)t} + \sum_{s=-\infty}^{\infty} u_s^* e^{-(p+j_s\Omega)t} \quad (23)$$

$$i = \sum_{s=-\infty}^{\infty} i_s e^{(p+j_s\Omega)t} + \sum_{s=-\infty}^{\infty} i_s^* e^{-(p+j_s\Omega)t} \quad (24)$$

and for the output parameters by

$$U = \sum_{s=-\infty}^{\infty} u_s e^{(p+j_s\Omega)t} + \sum_{s=-\infty}^{\infty} u_s^* e^{-(p+j_s\Omega)t} \quad (25)$$

$$I = \sum_{s=-\infty}^{\infty} \mathfrak{F}_s e^{(p+j_s\Omega)t} + \sum_{s=-\infty}^{\infty} \mathfrak{F}_s^* e^{-(p+j_s\Omega)t} \quad (26)$$

With several periods  $T = 1/\Omega$ , the spectrum in (23) through (26) must be extended to the additive combination frequencies. The frequency of the signal input voltage is again assumed to be  $\omega$ . When introducing these expressions into the four-pole equations available as time functions, for example (5) through (9), the spectrum of the input parameters can always be represented as a function of the output parameters through a matrix equation consisting of an infinite number of rows and columns.  $L(t)$ ,  $R(t)$ ,  $C(t)$ , or their reciprocal values are introduced into the four-poles as Fourier series according to (16) or (17). The number of unknowns can again be reduced to half by using only the spectral lines with positive  $p$  in the argument; the other half are merely the conjugated complex values of the unknowns used. The general matrix equation is

$$\begin{pmatrix} u_0 \\ u_{-1} \\ u_{+1} \\ u_{-2} \\ \cdot \\ \cdot \\ \cdot \\ i_0 \\ i_{-1} \\ i_{+1} \\ i_{-2} \\ \cdot \\ \cdot \\ \cdot \end{pmatrix} = \begin{pmatrix} S_{00} & S_{0-1} & S_{0+1} & \cdots \\ S_{-10} & S_{-1-1} & S_{-1+1} & \cdots \\ S_{+10} & S_{+1-1} & S_{+1+1} & \cdots \\ S_{-20} & \cdot & \cdot & \cdot \\ \cdot & \cdot & \cdot & \cdot \\ \cdot & \cdot & \cdot & \cdot \\ \cdot & \cdot & \cdot & \cdot \\ \mathbf{S} & & & \\ \cdot & & & \\ \cdot & & & \\ \cdot & & & \\ \cdot & & & \\ \cdot & & & \\ \cdot & & & \end{pmatrix} \begin{pmatrix} u_0 \\ u_{-1} \\ u_{+1} \\ u_{-2} \\ \cdot \\ \cdot \\ \cdot \\ \mathfrak{F}_0 \\ \mathfrak{F}_{-1} \\ \mathfrak{F}_{+1} \\ \mathfrak{F}_{-2} \\ \cdot \\ \cdot \\ \cdot \end{pmatrix} \quad (27)$$

By further dividing the primary and secondary values into even and odd harmonics of  $\Omega$ , matrix  $\mathbf{S}$  can be subdivided into 16 systems, each of which is a coupling matrix for the even or odd, primary or secondary, currents and voltages. With  $n$  the index for even harmonics and  $m$  for odd harmonics of  $\Omega$ , we then have

$$\sum s = \sum n + \sum m$$

$$\begin{pmatrix} (U_n) \\ (U_m) \\ (I_n) \\ (I_m) \end{pmatrix} = \begin{pmatrix} (S_{nn}^{uU}) & (S_{nm}^{uU}) & (S_{nn}^{iI}) & (S_{nm}^{iI}) \\ (S_{mn}^{uU}) & (S_{mm}^{uU}) & (S_{mn}^{iI}) & (S_{mm}^{iI}) \\ (S_{nn}^{iU}) & (S_{nm}^{iU}) & (S_{nn}^{iI}) & (S_{nm}^{iI}) \\ (S_{mn}^{iU}) & (S_{mm}^{iU}) & (S_{mn}^{iI}) & (S_{mm}^{iI}) \end{pmatrix} \begin{pmatrix} (U_n) \\ (U_m) \\ (I_n) \\ (I_m) \end{pmatrix} \quad (28)$$

The coefficients of matrix  $\mathbf{S}$  in (27) or (28) are composed of parameters that depend on the structure of the characteristic four-pole and on the control function of the time-varying elements it contains. They are functions in  $p$ . In the following, this matrix of a time-varying

four-pole is defined as spectral matrix  $\mathbf{S}$ . The form of (28), in particular, clearly indicates which parameters on the primary side are coupled to parameters on the secondary side. One or several of the 16 systems (each of which, incidentally, consists of an infinite number of elements) is quite likely to become a zero matrix. This would mean that the corresponding spectral lines on the primary and secondary sides are not coupled to each other. For four-poles consisting of only time-invariant elements and satisfying the conventional cascade matrix

$$(K) = \begin{pmatrix} A & B \\ C & D \end{pmatrix} \quad (29)$$

the spectral matrix  $\mathbf{S}$  of (28) degenerates into a matrix that, in accordance with the superposition theorem, represents the matrix (29) for all spectral frequencies present.

$$(S) = \begin{pmatrix} \begin{bmatrix} A_0 & 0 & \dots \\ 0 & A_{-2} & \dots \\ \cdot & \cdot & \cdot \\ \cdot & \cdot & \cdot \\ \cdot & \cdot & \cdot \end{bmatrix} & 0 & \begin{bmatrix} B_0 & 0 & \dots \\ 0 & B_{-2} & \dots \\ \cdot & \cdot & \cdot \\ \cdot & \cdot & \cdot \\ \cdot & \cdot & \cdot \end{bmatrix} \\ \begin{bmatrix} \cdot & \cdot & \cdot \\ \cdot & \cdot & \cdot \\ \cdot & \cdot & \cdot \\ \cdot & \cdot & \cdot \\ \cdot & \cdot & \cdot \end{bmatrix} & \begin{bmatrix} A_{-1} & 0 & \dots \\ 0 & A_{+1} & \dots \\ \cdot & \cdot & \cdot \\ \cdot & \cdot & \cdot \\ \cdot & \cdot & \cdot \end{bmatrix} & 0 & \begin{bmatrix} B_{-1} & 0 & \dots \\ 0 & B_{+1} & \dots \\ \cdot & \cdot & \cdot \\ \cdot & \cdot & \cdot \\ \cdot & \cdot & \cdot \end{bmatrix} \\ \begin{bmatrix} \cdot & \cdot & \cdot \\ \cdot & \cdot & \cdot \\ \cdot & \cdot & \cdot \\ \cdot & \cdot & \cdot \\ \cdot & \cdot & \cdot \end{bmatrix} & 0 & \begin{bmatrix} D_0 & 0 & \dots \\ 0 & D_{-2} & \dots \\ \cdot & \cdot & \cdot \\ \cdot & \cdot & \cdot \\ \cdot & \cdot & \cdot \end{bmatrix} & 0 \\ \begin{bmatrix} \cdot & \cdot & \cdot \\ \cdot & \cdot & \cdot \\ \cdot & \cdot & \cdot \\ \cdot & \cdot & \cdot \\ \cdot & \cdot & \cdot \end{bmatrix} & \begin{bmatrix} C_{-1} & 0 & \dots \\ 0 & C_{+1} & \dots \\ \cdot & \cdot & \cdot \\ \cdot & \cdot & \cdot \\ \cdot & \cdot & \cdot \end{bmatrix} & 0 & \begin{bmatrix} D_{-1} & 0 & \dots \\ 0 & D_{+1} & \dots \\ \cdot & \cdot & \cdot \\ \cdot & \cdot & \cdot \\ \cdot & \cdot & \cdot \end{bmatrix} \end{pmatrix} \cdot \quad (30)$$

## Spectral Matrix for Time-Varying Networks

From this we may derive the theorem. If the systems  $\mathbf{S}_{nm}$  and  $\mathbf{S}_{mn}$  in the spectral matrix are zero matrixes and  $\mathbf{S}_{nn}$  and  $\mathbf{S}_{mm}$  have different elements in the major diagonal of zero only, the four-pole consists of time-invariant elements. All other spectral matrixes define a four-pole containing time-varying elements (examples are given in Section 6). Analogous to the network theory, the spectral matrix will always be written with four systems

$$\begin{pmatrix} (u) \\ (i) \end{pmatrix} = \begin{pmatrix} (A) & (B) \\ (C) & (D) \end{pmatrix} \begin{pmatrix} (U) \\ (Y) \end{pmatrix} \quad (31)$$

with

$$(A) = (S^{uU}) = \begin{pmatrix} (S_{nn}^{uU}) & (S_{nm}^{uU}) \\ (S_{mn}^{uU}) & (S_{mm}^{uU}) \end{pmatrix} \quad (32A)$$

$$(B) = (S^{uI}) = \begin{pmatrix} (S_{nn}^{uI}) & (S_{nm}^{uI}) \\ (S_{mn}^{uI}) & (S_{mm}^{uI}) \end{pmatrix} \quad (32B)$$

$$(C) = (S^{iU}) = \begin{pmatrix} (S_{nn}^{iU}) & (S_{nm}^{iU}) \\ (S_{mn}^{iU}) & (S_{mm}^{iU}) \end{pmatrix} \quad (32C)$$

$$(D) = (S^{iI}) = \begin{pmatrix} (S_{nn}^{iI}) & (S_{nm}^{iI}) \\ (S_{mn}^{iI}) & (S_{mm}^{iI}) \end{pmatrix}. \quad (32D)$$

The spectral matrix may now be considered a cascade matrix of a network having an infinite number of input and output terminal pairs. This leads to the basic equivalent circuit of a time-varying four-pole as shown in Figure 2. Any number of such networks, whether time-varying or time-invariant, can be cascaded, there being only one condition to satisfy—that time-varying networks should not be cascaded with spectrally analyzed networks whose period  $T = 1/\Omega$  has not yet been considered. The equivalent circuit of two cascaded time-varying four-poles, for example, is a circuit of two networks with an infinite number of input and output terminal pairs (Figure 3). Mathematically, this denotes the multiplication of two spectral matrixes.

$$\begin{pmatrix} (u) \\ (i) \end{pmatrix} = \begin{pmatrix} (A_1) & (B_1) \\ (C_1) & (D_1) \end{pmatrix} \begin{pmatrix} (A_2) & (B_2) \\ (C_2) & (D_2) \end{pmatrix} \begin{pmatrix} (U) \\ (Y) \end{pmatrix}. \quad (33)$$

We obtain

$$\begin{pmatrix} (u) \\ (i) \end{pmatrix} = \begin{pmatrix} (A_1)(A_2) + (B_1)(C_2) & (A_1)(B_2) + (B_1)(D_2) \\ (C_1)(A_2) + (D_1)(C_2) & (C_1)(B_2) + (D_1)(D_2) \end{pmatrix} \begin{pmatrix} (U) \\ (Y) \end{pmatrix}. \quad (34)$$

Laws similar to those used in the four-pole theory are followed for calculations with matrixes of systems such as (31), so that these calculations may be considered to represent an advanced four-pole theory [10].

The most-essential difference is that the sequence of factors in the elements is not changeable now, for the elements as such represent matrixes. A discussion of the analogies with the well-known four-pole theory would be beyond the scope of this paper. The method for deriving a conductance matrix from a cascade matrix will, however, be shown here. The conductance matrix is to consist of the following kinds of systems

$$\begin{pmatrix} (i) \\ (Y) \end{pmatrix} = \begin{pmatrix} (Y_{11}) & (Y_{12}) \\ (Y_{21}) & (Y_{22}) \end{pmatrix} \begin{pmatrix} (U) \\ (I) \end{pmatrix}. \quad (35)$$

To convert an expression of the form (31) into the form (35), the first row of (35) is multiplied with the reciprocal matrix  $(B)^{-1}$

$$(B)^{-1}(u) = (B)^{-1}(A)(U) + (B)^{-1}(B)(Y).$$

Since  $(B)(B)^{-1}$  yields the unit matrix, we obtain

$$(Y) = (B)^{-1}(u) - (B)^{-1}(A)(U). \quad (36)$$

By introducing (36) into the second row of (31), the process is completed. We obtain

$$(i) = (C)(U) + (D)(B)^{-1}(u) - (D)(B)^{-1}(A)(U)$$

or

$$\begin{pmatrix} (i) \\ (Y) \end{pmatrix} = \begin{pmatrix} (D)(B)^{-1} & (C) - (D)(B)^{-1}(A) \\ (B)^{-1} & - (B)^{-1}(A) \end{pmatrix} \cdot \begin{pmatrix} (u) \\ (I) \end{pmatrix}. \quad (37)$$

## Spectral Matrix for Time-Varying Networks

The association of (35) and (37) can easily be determined. An analogous or similar procedure may also be used for the resistance and hybrid matrixes. Four-poles containing time-varying elements thus can be cascaded in the same manner as time-invariant four-poles, by first converting the spectral matrix of each individual four-pole into the suitable matrix and then proceeding in the frequency domain, as is customary in network theory.

The method of determining the propagation factors for the spectral frequencies of (31) is now discussed briefly. Equation (31) is assumed to be the cascade equation of a four-pole made up of an arbitrary number of time-varying and time-invariant elements, derived after the individual spectral matrixes have been determined and the cascading process has been completed. Let us assume that the time-varying four-pole is supplied by a source having the resistance  $R_1$  and that it is terminated with  $R_2$ , the latter being recognizable from the spectrally analyzed equivalent circuit (Figure 4). All voltages with the frequency  $p + js\Omega$  at the primary side drop across resistance  $R_1$  without supply voltages having been present for these frequencies. With the exception of  $s = 0$ , we can thus write

$$u_s = -i_s R_1. \quad (38)$$

For  $s = 0$

$$i_0 R_1 = e_0 - u_0. \quad (39)$$

With these two relations, the currents and voltages,  $i_s$  and  $u_s$ , can be eliminated, and the output voltage may be represented in a matrix equation as a function of  $e_0$ . The output currents are defined by  $\mathfrak{I}_s = u_s/R_2$ . In the first step, we obtain

$$\begin{bmatrix} u_0 \\ u_{-1} \\ \cdot \\ \cdot \\ \cdot \end{bmatrix} = (A) \begin{bmatrix} u_0 \\ u_{-1} \\ \cdot \\ \cdot \\ \cdot \end{bmatrix} + \frac{1}{R_2} (B) \begin{bmatrix} u_0 \\ u_{-1} \\ \cdot \\ \cdot \\ \cdot \end{bmatrix}. \quad (40A)$$

$$\begin{bmatrix} e_0 - u_0 \\ u_{-1} \\ \cdot \\ \cdot \\ \cdot \end{bmatrix} = (C) R_1 \begin{bmatrix} u_0 \\ u_{-1} \\ \cdot \\ \cdot \\ \cdot \end{bmatrix} + \frac{R_1}{R_2} (D) \begin{bmatrix} u_0 \\ u_{-1} \\ \cdot \\ \cdot \\ \cdot \end{bmatrix}. \quad (40B)$$

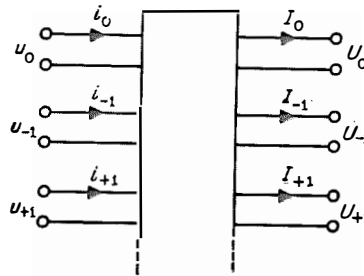

Figure 2—Equivalent circuit of a time-varying four-pole.

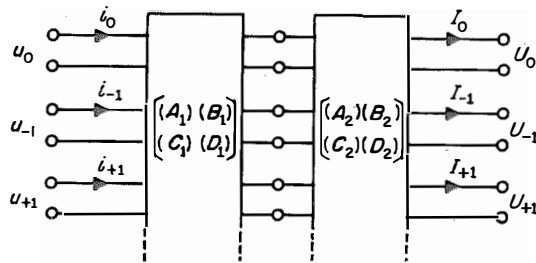

Figure 3—Equivalent circuit of a cascade of 2 time-varying four-poles.

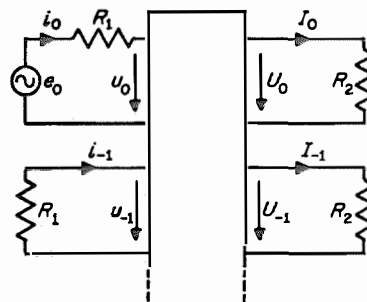

Figure 4—Terminated time-varying network.

## Spectral Matrix for Time-Varying Networks

By adding the corresponding rows  $s$  in (40A) and (40B), we have

$$\begin{bmatrix} e_0 \\ 0 \\ 0 \\ 0 \\ \vdots \\ \vdots \end{bmatrix} = \left( (\mathbf{A}) + \frac{1}{R_2} (\mathbf{B}) + R_1 (\mathbf{C}) + \frac{R_1}{R_2} (\mathbf{D}) \right) \begin{bmatrix} u_0 \\ u_{-1} \\ u_{+1} \\ \vdots \\ \vdots \end{bmatrix} \quad (41)$$

We now introduce selective transmission functions  $e^{\theta_0 s}$  of the primary input voltage  $e_0$  into the output voltages  $u_s$  (which can be measured selectively in practice) and obtain

$$e^{\theta_0 s} = \frac{e_0}{2u_s} \left( \frac{R_2}{R_1} \right)^{1/2}$$

from (41)

$$\begin{bmatrix} 1 \\ 0 \\ 0 \\ \vdots \\ \vdots \end{bmatrix} = \frac{1}{2} \left[ (\mathbf{A}) \left( \frac{R_2}{R_1} \right)^{1/2} + (\mathbf{B}) \frac{1}{(R_1 R_2)^{1/2}} + (\mathbf{C}) (R_1 R_2)^{1/2} + (\mathbf{D}) \left( \frac{R_1}{R_2} \right)^{1/2} \right] \begin{bmatrix} e^{-\theta_0 s} \\ e^{-\theta_0 s-1} \\ \vdots \\ \vdots \end{bmatrix} \quad (42)$$

It is, of course, also possible to derive the unknown voltages  $u_s$  from (41), but the similarity of (42) to the transmission function of the four-pole theory was to be demonstrated here [11-13]. This similarity is so close that (42) becomes identical with the well-known relation of four-pole theory if the systems  $(\mathbf{A})$ ,  $(\mathbf{B})$ ,  $(\mathbf{C})$ , and  $(\mathbf{D})$  have elements with different values other than zero only in the major

diagonal (they belong to a time-invariant four-pole). In this special case, only the result of  $e^{-\theta_0 s}$  will be other than zero, while all other  $e^{\theta_0 s}$  or  $u_{0s}$  will be zero. The reason is obvious—only one voltage with the frequency  $\omega + 0\Omega$  is supplied to the four-pole so that other frequencies  $\omega + s\Omega$  cannot be generated at all. With  $p = j\omega$ , we now derive the well-known equation

$$1 = \frac{1}{2} \left[ \left( \frac{R_2}{R_1} \right)^{1/2} \mathbf{A}(p) + \frac{1}{(R_1 R_2)^{1/2}} \mathbf{B}(p) + (R_1 R_2)^{1/2} \mathbf{C}(p) + \left( \frac{R_1}{R_2} \right)^{1/2} \mathbf{D}(p) \right] e^{-\theta_0 s}$$

Equation (42) represents for time-varying four-poles a system of an infinite number of unknowns and equations. An approximation of the unknowns  $e^{-\theta_0 s}$  can be made with an accuracy that depends on the number of equations used. Equation (42) is analogous to (18) except that it has been derived by the conventional methods of network theory. With  $D(p)$  the system determinant and  $D_s(p)$  the subdeterminant associated with the unknowns, the selective transmission functions may be expressed, in accordance with Cramer's rule, as functions of  $p$ .

$$e^{\theta_0 s} = \frac{D(p)}{D_s(p)} \quad (43)$$

The system determinant  $D(p)$  must have the same eigenvalues as the system determinant  $|S_{px}|$  of (18). Consequently, a determination of the eigenvalues is also possible by this method. With (25), the instantaneous value of the output voltage can easily be calculated. It is

$$U(t) = \frac{e_0}{2} \left( \frac{R_2}{R_1} \right)^{1/2} \left( \sum_{s=-\infty}^{\infty} e^{-\theta_0 s} e^{(p+j\Omega)t} + \sum_{s=-\infty}^{\infty} e^{-\theta_0 s*} e^{-(p+j\Omega)t} \right) \quad (44)$$

or written as a complex time-dependent transmission function of the instantaneous values



with  $u_0(t) = e_0 e^{pt}$

$$\begin{aligned}
 S(p,t) &= e^{-g(p,t)} = \frac{2u(t)}{u_0(t)} \left( \frac{R_1}{R_2} \right)^{1/2} \\
 &= e^{-g_{00}} + \sum_{s=-1}^{\infty} e^{-g_{0s} + js\Omega t} + \sum_{s=+1}^{\infty} e^{-g_{0s} + js\Omega t} \\
 &= \sum_{s=-\infty}^{\infty} e^{-g_{0s} + js\Omega t} = \sum_{s=-\infty}^{\infty} \frac{D_s(p)}{D(p)} e^{js\Omega t}. \quad (45)
 \end{aligned}$$

Therefore, the transmission factor of the instantaneous values (if defined as in (45), refer also to [2]) is time-dependent, as are all other known four-pole parameters. Time-dependence is shown later at the input resistances also. In practice, however, frequently only the selective transmission characteristics are of interest, particularly in the case of selective narrow-band systems where the frequencies  $\omega + s\Omega$  with  $s \geq 1$  are to be suppressed (modulators). Knowing the secondary voltages  $u_s$ , they are introduced into (31) to determine the voltages and currents  $u_s$  and  $i_s$ . In view of the relation (38) or (39), respectively, it is sufficient to determine, for example, only the voltages through (31). With (23) and (24), we derive from the complex instantaneous values

$$u(t) = \sum_{s=-\infty}^{\infty} u_s e^{p + js\Omega t}, \quad (46A)$$

$$i(t) = \sum_{s=-\infty}^{\infty} i_s e^{p + js\Omega t} \quad (46B)$$

a time-dependent instantaneous input resistance

$$\mathfrak{W}_{c,inst.} = \frac{u(t)}{i(t)} = \frac{\sum_{s=-\infty}^{\infty} u_s e^{p + js\Omega t}}{\sum_{s=-\infty}^{\infty} i_s e^{p + js\Omega t}}. \quad (47)$$

$u_s$  and  $i_s$  are obtained from one row each of the system of equations (31), for example

$$\begin{aligned}
 u_s &= \sum_{k=-\infty}^{\infty} a_{sk} u_k + \sum_{k=-\infty}^{\infty} b_{sk} \mathfrak{S}_k \\
 &= \sum_{k=-\infty}^{\infty} \left( a_{sk} + \frac{b_{sk}}{R_2} \right) u_k \quad (48)
 \end{aligned}$$

and

$$\begin{aligned}
 i_s &= \sum_{k=-\infty}^{\infty} c_{sk} u_k + \sum_{k=-\infty}^{\infty} d_{sk} \mathfrak{S}_k \\
 &= \sum_{k=-\infty}^{\infty} \left( c_{sk} + \frac{d_{sk}}{R_2} \right) u_k. \quad (49)
 \end{aligned}$$

$a_{sk}$ ,  $b_{sk}$ ,  $c_{sk}$ , and  $d_{sk}$  represent the individual elements of the systems (A), (B), (C), and (D).  $u_k$  are identical to the output voltages  $u_s$  of (41). As can be seen from (41), these output voltages are not proportional to the source resistance  $R_1$  so that the instantaneous input resistance in (47) is not independent of the source resistance  $R_1$  of the measuring source. Only in the case of selective systems, where all voltages but one approach zero at the output, this one desired output voltage (for instance  $u_{-1}$ , lower sideband for modulators) will be obtained after reduction of (47) because  $u_s$  and  $i_s$  in (48) and (49) will then be proportional only to this voltage  $u_{-1}$ . If the output voltages of (47) have no more influence, however, the input resistance is also independent of  $R_1$ . The selective input resistance  $\mathfrak{W}_0$ , obtained for the selective measurement at the input voltage of frequency  $\omega$ , is derived from (47) in conjunction with (48) and (49).

$$\mathfrak{W}_0 = \frac{u_0}{i_0} = \frac{\sum_{k=-\infty}^{\infty} \left( a_{0k} + \frac{b_{0k}}{R_2} \right) u_k}{\sum_{k=-\infty}^{\infty} \left( c_{0k} + \frac{d_{0k}}{R_2} \right) u_k}. \quad (50)$$

It is dependent on the source resistance  $R_1$  in the same manner. If system selectivity is so high that only one voltage  $u_k$  appears at the output while all other voltages are very small, (50) will become with very-close approximation

$$\mathfrak{W}_0 = \frac{R_2 a_{0k} + b_{0k}}{R_2 c_{0k} + d_{0k}}. \quad (51)$$

$k$  is the index of the only voltage appearing at the output. All the other parameters can also be derived from (31). The entire network is analyzed only in the frequency domain as this

## Spectral Matrix for Time-Varying Networks

permits calculating all parameters. The method used to determine the time function of the output amplitudes for certain input time functions is described in the following section.

### 5. Calculation of Output Amplitude Time Function for Arbitrary Input Functions

In the preceding section, the transmission factor of the time-varying system was represented in (44) or (45). In contrast to the transmission factors of time-invariant systems, those of time-varying systems are time-dependent in the stationary condition also. As a result, a single input frequency already produces a discrete spectrum at the output. Considering this on the basis of Fourier analysis of input signals, it means that several input frequencies are supplied and each of them produces a discrete spectrum at the output because of the system linearity. All these individual spectra are superposed in a linear manner at the output. Going one step further by applying a continuous spectrum to the input, for example a delta function, we must have at the output several or even-innumerable continuous spectra that are superposed, though displaced in frequency. The delta function can be written as an integral (referred to 1 direct volt)

$$U_{st} = \frac{1}{2\pi j} \int_{-j\infty}^{j\infty} e^{pt} dp. \quad (52)$$

According to Fourier, only one spectral frequency of  $\omega = -jp$  would then have the time function

$$u_p = \frac{dp}{2\pi j} e^{pt}$$

at the input of the time-varying system. At the output of the system we obtain, with the transmission factor known from (45), a sum of discrete frequencies  $p + s\Omega$  for the one spectral frequency. The output voltage is

$$u_z(t) = \frac{dp}{2\pi j} e^{pt} S(p, t)$$

$$= \frac{dp}{2\pi j} e^{pt} \sum_{s=-\infty}^{\infty} \frac{D_s(p)}{D(p)} e^{js\Omega t}. \quad (53)$$

The time function of the sum of the individual voltages produced by the delta function at the output can again be determined through integration.

$$\begin{aligned} u(t) &= \frac{1}{2\pi j} \int_{-j\infty}^{j\infty} S(p, t) e^{pt} dp \\ &= \frac{1}{2\pi j} \int_{-j\infty}^{j\infty} \sum_{s=-\infty}^{\infty} \frac{D_s(p)}{D(p)} e^{p+js\Omega t} dp \end{aligned} \quad (54)$$

or

$$u(t) = \frac{1}{2\pi j} \sum_{s=-\infty}^{\infty} e^{js\Omega t} \int_{-j\infty}^{j\infty} \frac{D_s(p)}{D(p)} e^{pt} dp \quad (55)$$

as the time function  $e^{js\Omega t}$ , which is independent of  $p$ , may be placed before the integral.

As is known, any other time function may be derived from the delta function by providing a following network having a transmission function of, for example,  $f(p)$ . For any time function to be applied to the input of the time-varying network, the associated transmission function  $f(p)$  must be found. This transmission function may then be assumed to precede the time-varying network, which corresponds to a multiplication  $f(p)S(p, t)$ . The output voltage then is

$$u(t) = \frac{1}{2\pi j} \sum_{s=-\infty}^{\infty} e^{js\Omega t} \int_{-j\infty}^{j\infty} f(p) \frac{D_s(p)}{D(p)} e^{pt} dp \quad (56)$$

or written with the signs of the Laplace transform ( $A(t)$  assumed as input time function, that is,  $f(p) = \mathcal{L}A(t)$ )

$$u(t) = \sum_{s=-\infty}^{\infty} e^{js\Omega t} \mathcal{L}^{-1} \left\{ \frac{D_s(p)}{D(p)} \cdot \mathcal{L}A(t) \right\}. \quad (57)$$

The time function  $e^{js\Omega t}$  thus does not enter into the integration process because it can be placed before the integral. As a result, the calculation of the time function can be reduced to the well-known relations of the Laplace transform if the spectral matrix of the time-varying network is known. The time function

of time-varying networks consists of the sum of selective time functions displaced in frequency by  $s\Omega$ . These selective time functions can be determined from the selection of time-independent transmission functions. All properties of time-varying networks can therefore be analyzed in the frequency domain by the known methods of network theory [18].

**6. Examples**

In conclusion, the spectral matrixes of some controlled four-poles are given in Table 2. With the given spectral matrix for the square-wave-controlled resistance diode ring modulator, selective frequency translators have been calculated using the *ER56* computer. Except for a negligible parallel displacement, the measured characteristic corresponds well to the calculated one. The parallel displacement is caused by calculating only 11 spectral frequencies of the system of equations [10, 14] (Figure 5). In the spectral matrix given, all elements were controlled by a square-wave function between +1 and -1, with the period  $T = 1/\Omega$ .

$$A(t) = \frac{4}{\pi} \sum_{m=1,3,5,\dots}^{\infty} \frac{(-1)^{\frac{m-1}{2}}}{m} \cos m\Omega t. \quad (58)$$

The following systems are frequently encountered in spectral matrixes.

(0) = Zero Matrix

(1) = Unit Matrix

$$(A) = \begin{bmatrix} 1 & 1 & -\frac{1}{3} & -\frac{1}{3} & \frac{1}{5} \\ 1 & -\frac{1}{3} & 1 & \frac{1}{5} & \cdot \\ -\frac{1}{3} & 1 & \frac{1}{5} & 1 & \cdot \\ \cdot & \cdot & \cdot & \cdot & \cdot \\ \cdot & \cdot & \cdot & \cdot & \cdot \end{bmatrix}$$

which is the coefficient matrix for square-wave control with

$$(p_n^{\pm 1}) = \begin{bmatrix} p_0^{\pm 1} & 0 & 0 & \cdot \cdot \\ 0 & p_{\pm 2}^{\pm 1} & 0 & \cdot \cdot \\ \bullet & 0 & p_{\pm 2}^{\pm 1} & \cdot \cdot \\ \cdot & \cdot & \cdot & \cdot \cdot \\ \cdot & \cdot & \cdot & \cdot \cdot \end{bmatrix}$$

$$(p_m^{\pm 1}) = \begin{bmatrix} p_{\pm 1}^{\pm 1} & 0 & 0 & \cdot \cdot \\ 0 & p_{\pm 1}^{\pm 1} & 0 & \cdot \cdot \\ 0 & 0 & p_{\pm 3}^{\pm 1} & \cdot \cdot \\ \cdot & \cdot & \cdot & \cdot \cdot \\ \cdot & \cdot & \cdot & \cdot \cdot \end{bmatrix}$$

$$p_n = p + jn\Omega, \quad p_m = p + jm\Omega.$$

Note that only the reciprocal spectral matrix  $S^{-1}$  exists for the periodic switch, because of the nonreversibility of the time equation. A value divided through  $1 + A(t)$ , that is, zero, would lead to uncertainties. In this case, however, the network may be arranged in the reverse direction with the reciprocal spectral matrix. After eliminating the secondary voltages and currents, the primary voltage is then determined first by (40) and (41).

**7. References**

1. L. A. Zadeh, "Frequency Analysis of Variable Networks," *Proceedings of the IRE*, volume 38, number 3, pages 291-299; March 1950.
2. L. A. Zadeh, "Time-Varying Networks," *Proceedings of the IRE*, volume 49, number 10, pages 1488-1503; October 1961.
3. S. Darlington, "An Introduction to Time-Varying Networks," *Proceedings of Symposium on Circuit Analysis*, University of Illinois, Urbana, Illinois; 1955.
4. B. K. Kinariwala, "Analysis of Time-Varying Networks," *IRE International Convention Record*, volume 9, part 4, pages 268-276; 1961.

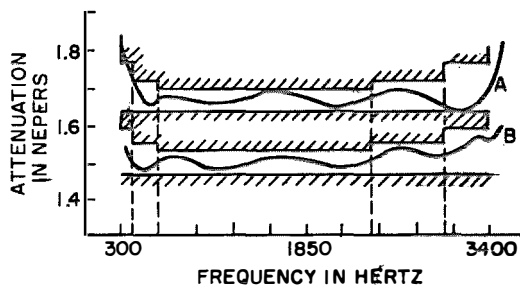

Figure 5—Calculated (A) and measured (B) transmission function of a frequency translator. The number of resonators  $N = 5$ .

TABLE 2  
EXAMPLES OF SPECTRAL MATRIXES FOR TIME-VARYING FOUR-POLES

Function	Time-Varying Four-Pole	Spectral Matrix
Diode Ring Modulator	 $\begin{pmatrix} u(t) \\ i(t) \end{pmatrix} = \begin{pmatrix} A(t) & 0 \\ 0 & A(t) \end{pmatrix} \begin{pmatrix} \cosh a & Z \sinh a \\ \frac{1}{Z} \sinh a & \cosh a \end{pmatrix} \begin{pmatrix} U(t) \\ I(t) \end{pmatrix}$ $Z = [(R_0 + r)(R_0 - r)]^{1/2}, \quad R_1 = R_0 + rA(t),$ $\tanh \frac{a}{2} = \left( \frac{R_0 - r}{R_0 + r} \right)^{1/2}, \quad R_2 = R_0 - rA(t).$	$S = \begin{bmatrix} (0) & \frac{2}{\pi} (A) & (0) & (0) \\ (0) & (0) & (0) & (0) \\ (0) & (0) & (0) & \frac{2}{\pi} (A) \\ (0) & (0) & (0) & (0) \end{bmatrix}$ $\begin{bmatrix} (1) \cosh a & (0) & (1) Z \sinh a & (0) \\ (0) & \cosh a(1) & (0) & Z \sinh a(1) \\ (1) \frac{1}{Z} \sinh a & (0) & (1) \cosh a & (0) \\ (0) & \frac{1}{Z} \sinh a(1) & (0) & \cosh a(1) \end{bmatrix}$
Inductance Ring Modulator	 $\begin{pmatrix} \int_0^t u(t) dt \\ i_1(t) \end{pmatrix} = \begin{pmatrix} 1 & L_p \\ 0 & 1 \end{pmatrix} \begin{pmatrix} ii & 0 \\ 0 & 1/ii \end{pmatrix} \begin{pmatrix} A(t) & 0 \\ 0 & A(t) \end{pmatrix}$ $\begin{pmatrix} 1 & 0 \\ 1/L_s & 1 \end{pmatrix} \begin{pmatrix} \int_0^t U(t) dt \\ I(t) \end{pmatrix}$ $L_1 = L_0 + LA(t), \quad L_p = L_0 - L^2/L_0, \quad ii^{-1} = L_0/L,$ $L_2 = L_0 - LA(t), \quad L_s = L^2/L_0, \quad L_0 > L,$	$S = \begin{bmatrix} (p_n) & (0) & L_p(P_n) & (0) \\ (0) & (p_m) & (0) & L_p(p_m) \\ (0) & (0) & (1) & (0) \\ (0) & (0) & (0) & (1) \end{bmatrix}$ $\begin{bmatrix} (0) & \frac{2}{\pi} ii(A) & (0) & (0) \\ (0) & (0) & (0) & (0) \\ (0) & (0) & (0) & \frac{2}{\pi} \frac{1}{ii} (A) \\ (0) & (0) & (0) & (0) \end{bmatrix} \begin{bmatrix} \left( \frac{1}{p_n} \right) & (0) & (0) & (0) \\ (0) & \left( \frac{1}{p_m} \right) & (0) & (0) \\ \frac{1}{L_s} \left( \frac{1}{p_n} \right) & (0) & (1) & (0) \\ (0) & \frac{1}{L_s} \left( \frac{1}{p_m} \right) & (0) & (1) \end{bmatrix}$

TABLE 2—Continued

Function	Time-Varying Four-Pole	Spectral Matrix
Periodic Switch	 $\begin{pmatrix} \frac{1+A(t)}{2} & 0 \\ 0 & 1 \end{pmatrix} \begin{pmatrix} u(t) \\ i(t) \end{pmatrix} = \begin{pmatrix} U(t) \\ I(t) \end{pmatrix}$ $(S^{-1}) \begin{pmatrix} u \\ i \end{pmatrix} = \begin{pmatrix} U \\ I \end{pmatrix}$	$S^{-1} = \begin{bmatrix} \frac{1}{2} (1) & \frac{1}{\pi} (A) & (0) & (0) \\ \frac{1}{\pi} (1) & \frac{1}{2} (1) & (0) & (0) \\ (0) & (0) & (1) & (0) \\ (0) & (0) & (0) & (1) \end{bmatrix}$
Resistance Modulator	 $R = R_0 + rA(t), \quad (R_0 > r)$ $\begin{pmatrix} u(t) \\ i(t) \end{pmatrix} = \begin{pmatrix} 1 & R_0 + rA(t) \\ 0 & 1 \end{pmatrix} \begin{pmatrix} U(t) \\ I(t) \end{pmatrix}$	$S = \begin{bmatrix} (1) & (0) & R_0(1) & \frac{2}{\pi} r(A) \\ (0) & (1) & \frac{2}{\pi} r(A) & R_0(1) \\ (0) & (0) & (1) & (0) \\ (0) & (0) & (0) & (1) \end{bmatrix}$
Parametric Capacitance	 $C = C_0 + CA(t), \quad (C_0 > C)$ $\begin{pmatrix} u(t) \\ \int_0^t i(t) dt \end{pmatrix} = \begin{pmatrix} 1 & 0 \\ C_0 & 1 \end{pmatrix} \begin{pmatrix} 1 & 0 \\ CA(t) & 1 \end{pmatrix} \begin{pmatrix} U(t) \\ \int_0^t I(t) dt \end{pmatrix}$	$S = \begin{bmatrix} (1) & (0) & (0) & (0) \\ (0) & (1) & (0) & (0) \\ C_0(p_n) & (0) & (p_n) & (0) \\ (0) & C_0(p_m) & (0) & (p_m) \end{bmatrix}$ $\begin{bmatrix} (1) & (0) & (0) & (0) \\ (0) & (1) & (0) & (0) \\ (0) & \frac{2}{\pi} C(A) & \left(\frac{1}{p_n}\right) & (0) \\ \frac{2}{\pi} C(A) & (0) & (0) & \left(\frac{1}{p_m}\right) \end{bmatrix}$

5. L. A. Pipes, "Four Methods for Analysis of Time-Variable Circuits," *Transactions of the IRE Professional Group on Circuit Theory*, volume CT-2, number 1, pages 4–12; March 1955.
6. L. A. Pipes, "Matrix Analysis of Linear Time-Varying Circuits," *Journal of Applied Physics*, volume 25, pages 1179–1185; 1954.
7. W. A. Taft, "Fragen zur Theorie der Netzwerke mit veränderlichen Parametern," Akademische Verlagsgesellschaft, Leipzig; 1962.
8. G. Wunsch, "Die mathematische Behandlung von linearen Systemen mit zeitvariablen Parametern," *Nachrichtentechnik*, volume 11, pages 221–222; 1962.
9. E. Kamke, "Differentialgleichungen," Akademische Verlagsgesellschaft, Leipzig; 1942.
10. C. Kurth, "Die Analyse von quasilinearen Frequenzumsetzern mit selektiven Ein- und Ausgangsnetzwerken," *Archiv der Elektrischen Uebertragung*, volume 17, pages 325–337; 1963.
11. W. Cauer, "Theorie der linearen Wechselstromschaltungen," Akademie Verlag, Berlin; 1957.
12. R. Feldtkeller, "Vierpoltheorie," S. Hirzel Verlag, Stuttgart; 1959.
13. C. Kurth, "Übersicht über die Berechnung von Filtern mit Verlusten nach der Betriebsparametertheorie," *Frequenz*, volume 10, pages 391–396; 1956.
14. C. Kurth, "Die Anwendung von digitalen Rechenanlagen bei der Analyse und Berechnung von Frequenzumsetzern mit selektiven Ein- und Ausgangsnetzwerken," *Archiv der Elektrischen Uebertragung*, volume 17, pages 381–390; 1963.
15. G. Wunsch, "Moderne Systemtheorie," Akademische Verlagsgesellschaft, Leipzig; 1962.
16. W. Klein, "Der klemmenzahlsymmetrische Mehrpol," *Archiv der Elektrischen Uebertragung*, volume 12, number 12, pages 533–539; 1958.
17. W. Klein, "Grundlagen der Theorie elektrischer Schaltungen," Akademie Verlag, Berlin; 1961.
18. C. Kurth, "Nullstellen und Pole in zeitvarianten Netzwerken," *Archiv der Elektrischen Uebertragung*, volume 17, pages 547–563; 1963.

**Carl Kurth** was born in Zwickau, Germany, on 11 May 1928. In 1951 he received a degree in electrical engineering from Mittweida polytechnic.

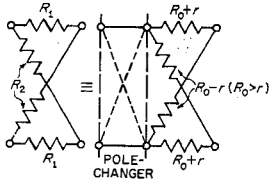
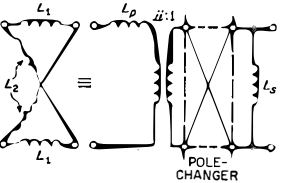
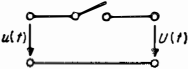
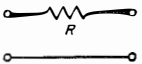
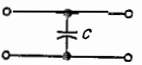
After working in the fields of radio and communication systems, he joined Standard Elektrik Lorenz in 1960, where he was concerned with the application of computers to network design. He is now chief of the basic research laboratory in the Transmission and Navigation Division.

# Coded-Linear-Array Antenna

FRANK S. GUTLEBER

ITT Federal Laboratories, A Division of International Telephone and Telegraph Corporation; Nutley, New Jersey

## 1. Introduction

The primary function of an antenna is to accomplish an impedance match between a transmission line and free space in order to radiate electromagnetic energy into free space. In addition, the antenna must radiate in the desired directions and (sometimes more important) must suppress the radiation in other directions.

Many investigations of array antennas have been made to establish methods of reducing or controlling side lobes. In the past, the main emphasis has been on adjusting the amplitudes of the individual elements of a uniform array according to a binomial, triangular, Chebishev, or other type of distribution. Recently, the use of nonuniform element separation to reduce grating lobes [1] and a perturbation procedure using nonuniform element spacing to effect side-lobe reduction [2] have been proposed.

In this paper, a simple and direct optimization procedure is established that readily determines a specific space pattern or code yielding every desired null point in a composite beam radiation pattern. In addition, the analysis is extended by a constraint equation. This expedient permits the code positions to be forced into preselected slot spacings, resulting in a combined coding for both element spacing and amplitude.

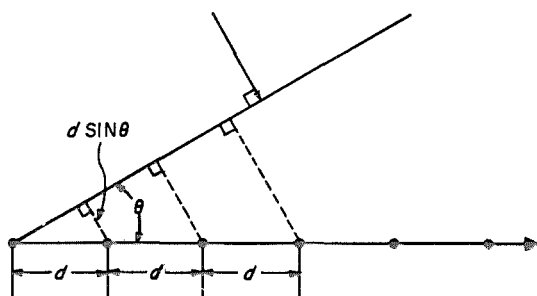

Figure 1—Means of determining the relative field strength pattern of a uniform linear array.

## 2. Analysis

The relative field strength pattern of a uniform linear array is readily established (see Figure 1) as

$$e_i = a_0 + a_1 \exp(j\psi) + a_2 \exp(j2\psi) + a_3 \exp(j3\psi) + \dots + a_{n-1} \exp[j(n-1)\psi] \quad (1)$$

where

$$\psi = \beta d \sin \theta + \alpha$$

$$\beta = 2\pi/\lambda$$

$\lambda$  = wavelength

$d$  = spacing between elements (assumed constant)

$\theta$  = angle between wave front and array axis

$\alpha$  = progressive phase shift\*

$a_i$  = amplitude weighting associated with  $i$ th element.

It is easily shown that such an antenna configuration results in a beam pattern with a  $(\sin x)/x$  distribution when the amplitudes of the various elements are weighted equally, that is

$$a_0 = a_1 = a_2 = \dots = a_{n-1}.$$

If the amplitudes are weighted equally, but the element spacings are nonuniform, the

---

\* For the remainder of the analysis,  $\alpha$  is assumed equal to zero ( a broadside array).

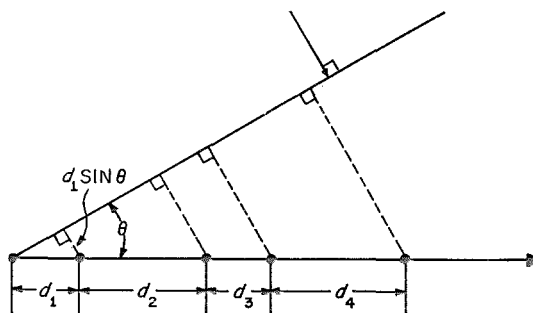

Figure 2—Means of determining the relative field strength pattern when the elements are nonuniformly spaced.

resulting field pattern for the array would be given (see Figure 2) by

$$e_i = 1 + \exp(j\psi_1) + \exp(j\psi_2) + \dots + \exp(j\psi_{n-1}) \quad (2)$$

where

$$\begin{aligned} \psi_1 &= \frac{2\pi}{\lambda} d_1 \sin \theta \\ \psi_2 &= \frac{2\pi}{\lambda} (d_1 + d_2) \sin \theta \\ &\vdots \\ \psi_{n-1} &= \frac{2\pi}{\lambda} (d_1 + d_2 + \dots + d_{n-1}) \sin \theta. \end{aligned}$$

An alternative way of representing (2) is

$$e_i = \exp(jn_1\psi) + \exp(jn_2\psi) + \dots + \exp(jn_m\psi) \quad (3)$$

where

$$\begin{aligned} \psi_0 &= n_1\psi, \quad n_1 = 0 \\ \psi_1 &= \frac{d_1}{d} \psi = n_2\psi \\ \psi_2 &= \frac{d_1 + d_2}{d} \psi = n_3\psi \\ \psi_{n-1} &= \frac{d_1 + d_2 + \dots + d_{n-1}}{d} \psi = n_m\psi \end{aligned}$$

and

$$\psi = \frac{2\pi}{\lambda} d \sin \theta.$$

$d$  corresponds to some constant spacing that establishes the physical code positions when multiplied by the code terms  $n_i$ . It is equal to the total array length  $L$  divided by the largest code number.

$$\begin{aligned} \frac{\psi_{n-1}}{\psi} &= \frac{d_1 + d_2 + \dots + d_{n-1}}{d} = n_m \\ &= L/d \end{aligned}$$

and

$$d = L/n_m.$$

Equation (3) establishes the field pattern for a specific code set of elements  $n$  and spacing  $d$ . We desire a method of determining values of  $n$  and  $d$  that will yield a required pattern. Such a method may be evolved in the following

manner. For each general term  $\exp(jn\psi) = Z_n$  that exists, a second term  $\exp(jn'\psi) = Z_{n'}$  can be added having its argument 180 degrees out of phase with the existing term for a specific value of space angle  $\theta$ . This would ensure that the resultant amplitude equalled zero at the value of  $\theta$  in question.

$$\begin{aligned} \arg Z_{n'} &= \arg Z_n + \pi \\ n'\psi &= n\psi + \pi. \end{aligned} \quad (4)$$

Since

$$\begin{aligned} \psi &= \frac{2\pi}{\lambda} d \sin \theta \\ n' &= n + \frac{\lambda}{2d \sin \theta}. \end{aligned} \quad (5)$$

Making the following substitution

$$\frac{1}{K} = \frac{\lambda}{d \sin \theta} \quad (6)$$

yields

$$n' = n + \frac{1}{2K}. \quad (7)$$

Equation (7) identifies the required coded element positions resulting in a null or zero at any specific desired value of  $\theta$  or  $K$ . For example, if nulls have been forced at several space angles and an additional null is desired, an additional element must be added for each existing one. Although this would not necessarily be a requirement to obtain a zero at the new value of  $\theta$ , it does ensure that all the original nulls will be retained. That is, this process cannot result in any increase in the amplitudes of the lobes anywhere in the pattern, because the over-all antenna pattern consists of the product of the separate patterns formed by  $Z_n$  and  $Z_n$  with  $Z_{n'}$ . This important aspect of the proposed design procedure is verified in Section 8.1.

The equations are normalized by letting  $K$  equal unity at the first zero in the antenna pattern. That is,  $K = 1$  when  $\theta = \theta_0 =$  first zero of the antenna pattern. Then

$$d = \frac{\lambda}{\sin \theta_0}. \quad (8)$$



Hence

$$\psi = 2\pi \left( \frac{\sin \theta}{\sin \theta_0} \right). \quad (9)$$

Substituting (8) into (6) yields

$$K = \frac{\sin \theta}{\sin \theta_0}. \quad (10)$$

Therefore

$$\psi = 2\pi K \quad (11)$$

and

$$n_i \psi = n_i 2\pi K. \quad (12)$$

All  $n_i$  existing in a final developed code determine the explicit element spacings required. The physical code positions expressed in terms of the wavelength are obtained simply by multiplying the relative code positions  $n_i$  by  $d$ .

We now have a general design procedure that enables elements to be positioned where they can have the greatest effect in reducing side lobes. The repeated application of (7) obtains zeros or nulls at all desired values of  $K$  for the design under consideration. In fact, nulls exist at the products of all odd integers by the desired values of  $K$ . This is verified in Section 8.2.

The general equation is used as follows. Consider a second element (omnidirectional antenna) spaced from a reference antenna a distance producing the required first null for the desired beamwidth  $\theta_0$  ( $K = 1$ ).

$$n = 0 = \text{reference element}$$

$$n' = n + \frac{1}{2K} = \frac{1}{2} = \text{second element.}$$

This yields the two elements

$$n_1 = 0$$

$$n_2 = \frac{1}{2}.$$

Let  $K = a$  produce the second forced null. This requires adding the two elements.

$$n' = n_1 + \frac{1}{2a} = \frac{1}{2a} = n_3$$

$$n' = n_2 + \frac{1}{2a} = \frac{a+1}{2a} = n_4.$$

We now have the following four elements forcing a null at  $K=1$  and  $K=a$ .

$$n_1 = 0$$

$$n_2 = \frac{1}{2}$$

$$n_3 = \frac{1}{2a}$$

$$n_4 = \frac{a+1}{2a}.$$

Forcing a null to occur at  $K=b$  requires the following four additional element positions.

$$n' = n_1 + \frac{1}{2b} = \frac{1}{2b} = n_5$$

$$n' = n_2 + \frac{1}{2b} = \frac{b+1}{2b} = n_6$$

$$n' = n_3 + \frac{1}{2b} = \frac{a+b}{2ab} = n_7$$

$$n' = n_4 + \frac{1}{2b} = \frac{b(a+1)+a}{2ab} = n_8.$$

Repeating this process for  $K=c$ ,  $K=d$ , et cetera, will establish identifying code positions for any quantity of forced zeros desired and at any positions desired.

### 3. Application of Theory

The following three codes corresponding to the indicated design nulls were obtained for the purpose of illustrating the results of the proposed technique in addition to verifying the theory. They are not intended to establish a desirable or near-optimum code.

(A) Code 1 is a 16-element code with forced nulls at  $K = 1, 3/2, 2$ , and 4.

(B) Code 2 is a 32-element code with forced nulls at  $K = 1, 5/4, 3/2, 2$ , and 4.

(C) Code 3 is a 16-element code with forced nulls at  $K = 1, 5/4, 3/2$ , and 11/6.

Equation (3) can now be used to obtain the antenna field pattern corresponding to (A)

## Coded-Linear-Array Antenna

through (C).

$$e_t = \exp(jn_1\psi) + \exp(jn_2\psi) + \dots + \exp(jn_m\psi) \quad (13)$$

$$= (\cos n_1\psi + \cos n_2\psi + \dots + \cos n_m\psi) + j(\sin n_1\psi + \sin n_2\psi + \dots + \sin n_m\psi) \quad (14)$$

$$|e_t| = [(\sum_{\text{all } n_i} \cos n_i\psi)^2 + (\sum_{\text{all } n_i} \sin n_i\psi)^2]^{1/2} \quad (15)$$

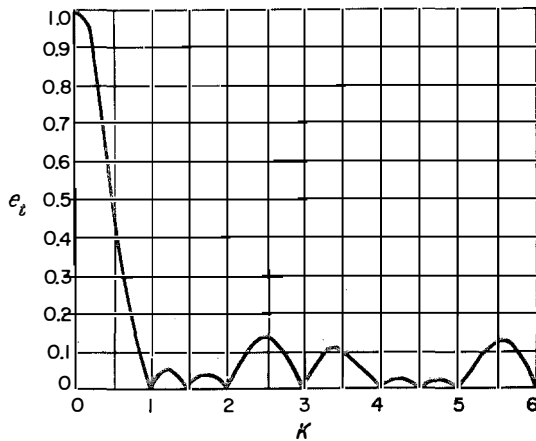

Figure 3—Normalized field strength pattern for code 1 (16 elements).  $K = 1, 3/2, 2,$  and  $4$ .  $K = \sin \theta / \sin \theta_0$ .  $K_{\max} = 6$ .

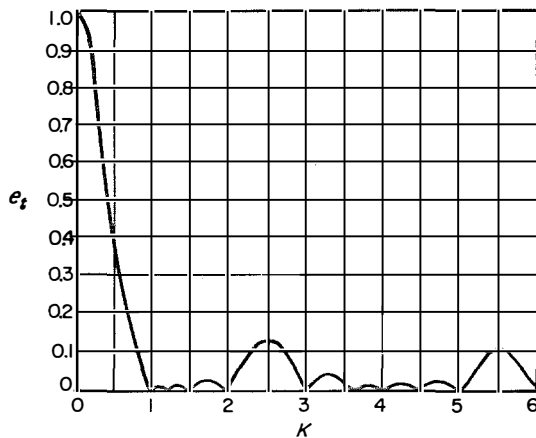

Figure 4—Normalized field strength pattern for code 2 (32 elements).  $K = 1, 5/4, 3/2, 2,$  and  $4$ .  $K = \sin \theta / \sin \theta_0$ .  $K_{\max} = 6$ .

where  $\sum_{\text{all } n_i}$  signifies the summation for all  $n_i$  terms present in the code.

Since  $n_i\psi = n_i 2\pi K$ , hence

$$|e_t| = [(\sum_{\text{all } n_i} \cos n_i 2\pi K)^2 + (\sum_{\text{all } n_i} \sin n_i 2\pi K)^2]^{1/2} \quad (16)$$

Equation (16) is readily programmed for a computer to yield the antenna field pattern as a function of  $K$ , which can easily be interpreted in terms of the space angle  $\theta$ . The final plot corresponds to any physical beamwidth desired, since it is normalized for the first null point. The corresponding physical code spacings will of course be different and the largest value of  $K$  of concern will change as  $\theta_0$  assumes different values. When the space angle  $\theta$  is equal to its maximum possible value (90 degrees for a ground antenna),  $K$  will reach its maximum value, which must be considered. Since

$$K = \frac{\sin \theta}{\sin \theta_0}$$

$$K_{\max} = \frac{1}{\sin \theta_0}$$

Larger values of  $K$  would have no physical significance. In the design examples used

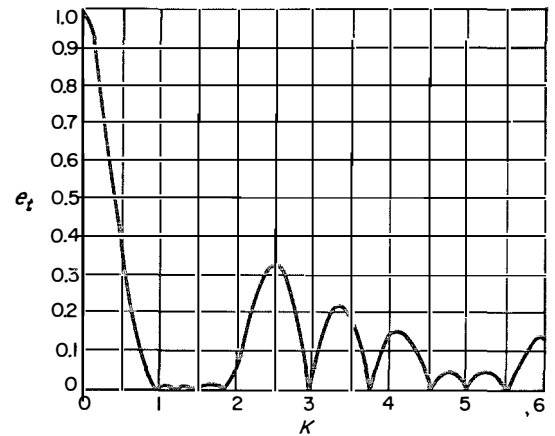

Figure 5—Normalized field strength pattern for code 3 (16 elements).  $K = 1, 5/4, 3/2,$  and  $11/6$ .  $K = \sin \theta / \sin \theta_0$ .  $K_{\max} = 6$ .

throughout this paper, a value of 9.25 degrees was arbitrarily used for  $\theta_0$  in order to fix  $K_{max}$  at a convenient value for analysis. Since  $\sin 9.25 \text{ degrees} = 1/6$ ,  $K_{max} = 6$ .

The antenna beam pattern was computed for the three previous design codes and is plotted in Figures 3, 4, and 5 up to  $K_{max} = 6$ . Code 1 uses forced nulls at  $K = 1, 3/2, 2,$  and  $4$ . Therefore zeros will be anticipated at  $1, 1.5, 2, 3, 4, 4.5, 5,$  and  $6$ . This is verified in the resultant plot of field strength versus  $K$  in Figure 3. Code 2 is the same as code 1 with an additional forced null at  $K = 5/4$ . This establishes two additional zero points in the over-all plot at  $K = 1.25$  and  $3.75$ , which are verified in Figure 4. Code 3 consists of forced nulls at  $K = 1, 5/4, 3/2,$  and  $11/6$ , resulting in zeros at  $1, 1.25, 1.5, 1.83, 3, 3.75, 4.5, 5,$  and  $5.5$ . This is illustrated in Figure 5.

Note that the peak amplitude of any lobe generally increases as the spacing between two adjacent zero points increases. This indicates that a design approaching an optimum condition (field pattern containing equal side-lobe amplitudes) should use design nulls equispaced along the  $K$  axis. This is not true in general. It occurs in the chosen examples, since the multiplied antenna patterns are similar because the values of desired  $K$  were

restricted to the same order of magnitude. Despite this, the observation is significant since it permits desired results to be obtained. Codes 1 and 2 are shown on a single plot in Figure 6 to illustrate the effect of the added forced null in code 2. This comparison plot indicates two important conditions. First, the amplitudes of the original lobes either remain the same or decrease as new zeros are forced. Second, the beamwidth at the half-power point is narrower for code 2 because the additional design  $K$  is near unity.

Based on the results for the previous codes and the developed theory, a near-optimum design is now considered. Such a code (code 4) was obtained using design nulls at  $K = 1, 7/6, 4/3, 3/2, 11/6,$  and  $5/2$ . In this code, the zero points are essentially equispaced by  $0.5$  between  $K = 1$  and  $K = 6$ , except that some of the desired values of  $K$  were chosen to achieve the desired nulls from the product of some odd integer by  $K$ . This yields additional zeros without requiring extra elements and is the basic reason why lobes adjacent to the main beam can be suppressed more effectively than lobes farther away. In addition, the main beamwidth is reduced by obtaining desired zeros as the products of odd integers by the desired values of  $K$ .

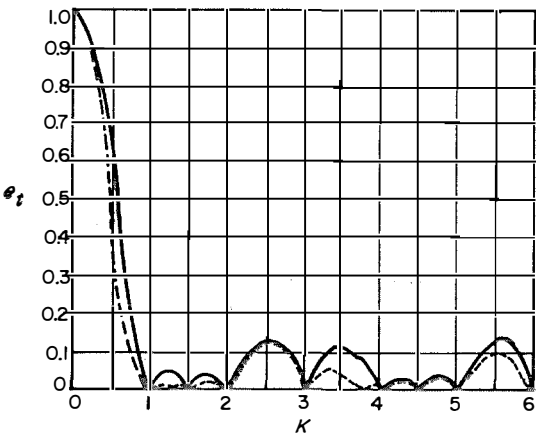

Figure 6—Normalized field strength pattern for codes 1 (solid line) and 2 (broken line).  $K_{max} = 6$ .

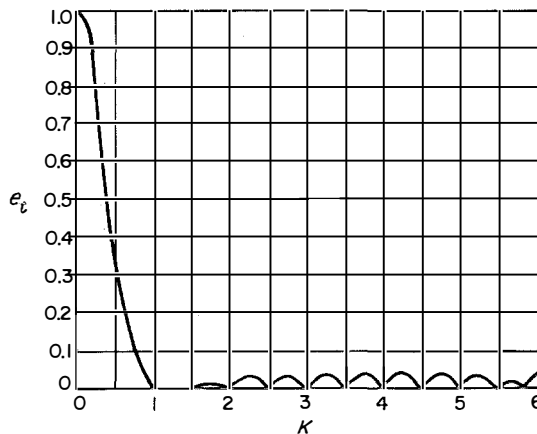

Figure 7—Normalized field strength pattern for code 4 (64 elements).  $K = 1, 7/6, 4/3, 3/2, 11/6,$  and  $5/2$ .  $K = \sin \theta / \sin \theta_0$ .  $K_{max} = 6$ .

## Coded-Linear-Array Antenna

A plot of the relative field strength is shown in Figure 7. As before, a zero occurs in the pattern for all  $K_0M$ , where  $K_0$  represents the design values for  $K$ , and  $M$  corresponds to all odd integers. Note that the amplitudes of the lobes are essentially equal except for the lobes adjacent to the main beam, which have been reduced to a negligible value. Since the maximum value of  $K$  was taken as 6,  $\sin \theta_0 = 1/6$ . The first zero would occur at  $\theta_0 = \sin^{-1} (1/6) = 9.25$  degrees, and the beamwidth at the half-power point  $\theta_b$  occurs at  $K = 0.3$  (see Figure 7). Therefore

$$\begin{aligned}\theta_b &= \sin^{-1} (0.3 \sin \theta_0) \\ &= 2^\circ 52' .\end{aligned}$$

The total 3-decibel-down beamwidth  $2\theta_b$  is then

$$2\theta_b = 5^\circ 44' .$$

The antenna beam pattern as a function of the space angle  $\theta$  is readily obtained from the relation  $\theta = \sin^{-1} (K \sin \theta_0)$ . This was computed for code 4 and is illustrated in Figure 8.

Figure 9 is a plot of the antenna pattern for code 4 up to a value of  $K = 30$ . It has no physical significance beyond  $K = 6$ , but is presented to demonstrate that the selected design values of  $K$  have been chosen to achieve an optimum result for  $K_{\max} = 6$ . A better choice of design values of  $K$  would no doubt exist for a different required beamwidth. Any design, however, may be complemented

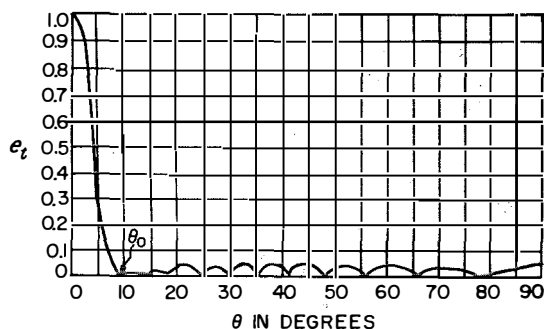

Figure 8—Normalized field strength pattern plotted as a function of the space angle  $\theta$ , using code 4.  $\theta = \sin^{-1} K \sin \theta_0$ , where  $\theta_0 = \sin^{-1} (1/6)$ .  $K_{\max} = 6$ .

to accomplish a good lobe structure for a narrower beamwidth. It is apparent from Figure 9 that if an additional null is formed at  $K = 6.2$ , a good over-all response will be anticipated up to  $K_{\max} = 8.4$ . The plot in Figure 9 also demonstrates that large lobes can be maintained in a given antenna design by ensuring that zeros do not occur in a specified region of interest.

### 4. Analysis for Obtaining Code Positions Occupying Predetermined Slot Spacings

Thus far, no restriction has been placed on the antenna element positions. For a specific application, many ideal codes might require that the spacing between some of the elements be unreasonably small. This problem was solved by placing a constraint on the design equations, forcing the code positions to fall into predetermined slot spacings. The basic technique is readily modified to accommodate such a constraint.

The general equation establishing the relative code spacings is given by

$$n' = n + \frac{1}{2K} . \quad (17)$$

Since the physical code positions in wavelengths are obtained from the products of the code  $n_i$  times  $d$

$$n'd = nd + \frac{d}{2K} . \quad (18)$$

This equation states that each added element is spaced from some existing element by  $d/2K$ , that is

$$\Delta S = n'd - nd = \frac{d}{2K} . \quad (19)$$

Since

$$d = \frac{\lambda}{\sin \theta_0} \quad (8)$$

$$\Delta S = \frac{\lambda}{2K \sin \theta_0} . \quad (20)$$

We now desire that all the values of  $\Delta S$  be restricted to some specified fraction of a

wavelength times an integer. Therefore we will force  $\Delta S$  to be equal to

$$\Delta S = \frac{\lambda}{X} N \tag{21}$$

where

$\lambda$  = wavelength

$1/X$  = the fraction of the wavelength the slots are to correspond to

$N$  = any integer.

Combining (20) and (21) yields

$$\frac{\lambda}{2K \sin \theta_0} = \frac{\lambda}{X} N. \tag{22}$$

Hence

$$K = \frac{X}{2N \sin \theta_0} \tag{23}$$

is the desired constraint which, when imposed directly on the design nulls, will force the code positions into slots given by some integer times  $\lambda/X$ . At first glance this might appear to be a severe restriction, but this is not the case and very-good antenna patterns may be realized.

It is apparent from the constraint equation that the desired values of  $K$  are restricted by the two parameters  $\theta_0$  and  $X$ . This permits two degrees of freedom since a single result can correspond to several solutions, with the appropriate value of  $\theta_0$  corresponding to a specified  $X$  or the appropriate value of  $X$  corresponding to a specified  $\theta_0$ . It must be remembered, however, that the  $K_{max}$  of concern is a function of  $\theta_0$  and is given by

$$K_{max} = \frac{1}{\sin \theta_0}. \tag{24}$$

Therefore, if a specific set of design nulls yields a desirable pattern up to  $K_{max} = K_0$ , the minimum value of  $\theta_0$  is limited to

$$\theta_{0(min)} = \sin^{-1} \left( \frac{1}{K_0} \right).$$

Let us now define a single parameter  $D$  as

$$D \equiv \frac{X}{2 \sin \theta_0}. \tag{25}$$

Then  $K = D/N$ .

The maximum value that  $N$  can have is equal to  $D$ , since the design values of  $K$  cannot be less than unity because of the normalizing technique used in the basic analysis.

A synthesis of a design example of a slot-coded array will clarify the significance of the constraint equation on the design procedure. It will also demonstrate that the modified technique can establish near-optimum results. Let us consider restricting the slot spacings to  $\lambda/4$  and choose a value of  $\theta_0 = \sin^{-1} (1/6)$  to achieve a result that can be compared directly with the near-optimum design example (code 4). Using these values for  $\sin \theta_0$  and  $X$  yields a value of 12 for  $D$ .

The *available* design values for  $K$  are then restricted to

$$K = 12/N = 12, 6, 4, 3, 12/5, 2, 12/7, 3/2, 4/3, 6/5, 12/11, \text{ and } 1.$$

For code 4, the selected values for  $K$  were

$$K = 5/2, 11/6, 3/2, 4/3, 7/6, \text{ and } 1.$$

An equivalent design is approached simply by using available values of  $K$  closest to the desired values. A value of 1 exists in both sets.  $K = 6/5$  will be used in place of  $K = 7/6$ , since  $7/6$  was chosen in the original code to

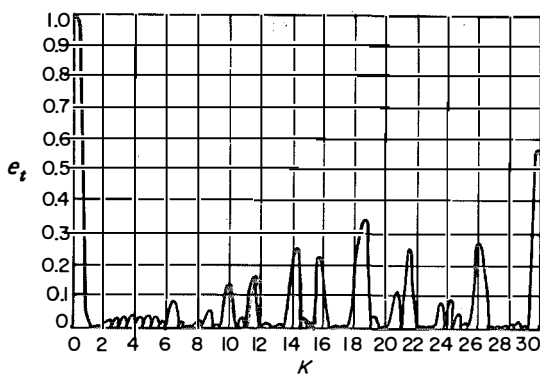

Figure 9—Normalized field strength pattern for code 4 (64 elements) up to a maximum value of  $K = 30$ .  $K = 1, 7/6, 4/3, 3/2, 11/6, \text{ and } 5/2$ .  $K = \sin \theta / \sin \theta_0$ .

## Coded-Linear-Array Antenna

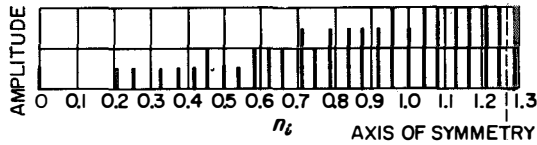

Figure 10—Space positions of elements and their excitation amplitudes for code 5.  $K = 1, 12/11, 6/5, 4/3, 3/2, 2,$  and  $12/5$ .  $D = 12$ . A mirror image of the figure exists to the right of the axis of symmetry.

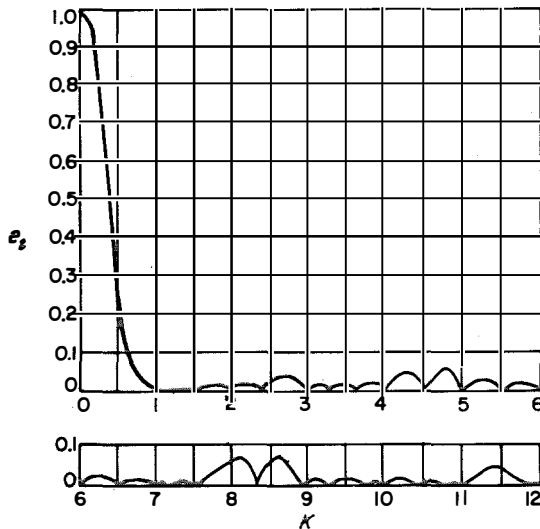

Figure 11—Normalized field strength patterns for code 5.  $K = 1, 12/11, 6/5, 4/3, 3/2, 2,$  and  $12/5$ .  $K_{\max} = 6$ .  $D = 12$ .

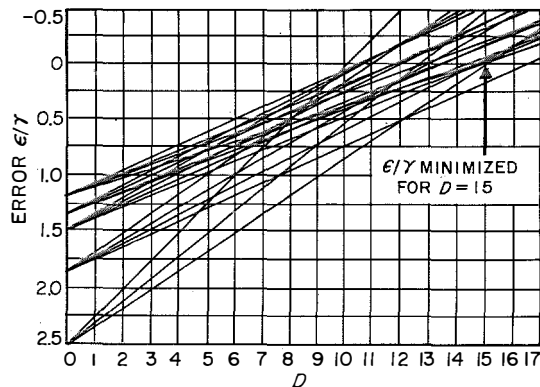

Figure 12—Plot of error as a function of  $D$  for desired  $K$  ( $K_d$ ) of code 4.  $\epsilon/\gamma = (D/N) - K_d$ , where  $K_d = 1, 7/6, 4/3, 3/2, 11/6,$  and  $5/2$ .

yield a zero at 3.5 ( $7/6 \times 3 = 3.5$ ) and  $6/5$  yields a zero at 3.6, which is quite close to the desired null.  $K = 4/3$  and  $3/2$  exists in both sets.  $K = 12/11$  will be used in place of  $K = 11/6$ , to provide a zero at 5.45. The value of  $11/6$  yielded a desired zero at 5.5.  $K = 12/5 = 2.4$  will be used to obtain a zero close to 2.5, which was the last  $K$  value of the original code. The only null position of the original code not having a null very close to it in the new restricted code is at  $11/6$ . This zero point of the original code was used to provide a zero at 5.5 and was considered sufficiently close to 2 not to require a design zero at 2. To fill the gap by keeping the zeros as equispaced as possible, an additional  $K$  equal to 2 will be used in the new code. Such a value is available in the restricted values for  $K$ . The desired values of  $K$  for the new restricted code (code 5) are then

$$K = 1, 12/11, 6/5, 4/3, 3/2, 2, \text{ and } 12/5.$$

This results in a 128-element antenna with the relative code spaces given by

$$n' = n + \frac{1}{2K}. \quad (17)$$

That is

$$n_1 = 0$$

$$n_2 = n_1 + \frac{1}{2} = 0.5$$

$$n_3 = n_1 + \frac{1}{2(12/11)} = \frac{11}{24} = 0.45833$$

$$n_4 = n_2 + \frac{1}{2(12/11)} = 0.95833$$

et cetera.

These code positions take the form shown in Figure 10. Note that in 36 slot positions coincidence occurs for from 2 to 4 elements. This illustrates that the general technique of space coding is actually a combination of coded spaces and amplitudes. The fact that the first four codes contained equal amplitude weighting for all the final positions was simply the result of the choice of  $K$  used in the design.

The condition that induces coded spaced elements to coincide can be expressed by the following equation, derived in Section 8.3.

$$\sum_{\text{all } j} N_j = \sum_{\text{all } j'} N_{j'} \quad (26)$$

where  $\sum_{\text{all } j}$  signifies the summation of all the  $N_j$  values that are present in establishing a code position  $n_i$ . This can consist of 1, all, or any combination of the  $N_j(N_j = D/K_j)$  values making up the complete code. Any design can be assured of containing only equal amplitude weighting for all of its elements if the inverse of (26) is satisfied. That is,

$$\sum_{\text{all } j} N_j \neq \sum_{\text{all } j'} N_{j'} \quad (27)$$

The equations depicting element coincidence show that designs using large values of  $D$  are generally less susceptible to element coincidence. However, a large value for  $D$  also requires smaller slot spacings between elements for a specified  $\theta_0$ .

Code 5 was designed as a 128-element array that resulted in four digitized levels because of element coincidence. Considering that it is based on 128 code positions, this quantity is small enough to retain a distinct advantage over uniform-array amplitude-taper designs. Another notable advantage is gained through the reduction of physical elements as coincidence occurs. Instead of 128 antenna elements, only 52 are needed. This is 12 elements fewer than required in the design of code 4. The field strength pattern for this code is plotted in Figure 11. It can be seen from this curve that the restricted code approximates an optimum result quite closely. Because of the basic technique, lobes adjacent to the main beam are still-more-easily suppressed than lobes farther away.

We now have a procedure that permits forcing code positions to fall into existing slot increments and still result in a near-optimum design. However, since the parameter  $D$  can

vary over a limited region without much effect on  $X$  or  $\theta_0$ , an optimum choice of  $D$  might exist in any region of interest. An optimum value of  $D$  would result in a best-matching capability between sets of desired and available values of design  $K$ . One method indicating the preferred  $D$  in a given operational region is to minimize the maximum error between desired and available values of design  $K$ . The set of equations that indicates the magnitude of the errors resulting from a specific choice of  $D$  is derived in Section 8.4. These equations will be used in conjunction with the desired values of design  $K$  used in code 4. It is desired to find for  $D$  a value near  $D = 12$  that will yield a best match between the available and desired values of design  $K$ . For this example, the error equations become

$$\begin{aligned} \frac{\mathcal{E}_1}{M_1} &= \frac{D}{N_1} - 1 & \frac{\mathcal{E}_4}{M_4} &= \frac{D}{N_4} - \frac{3}{2} \\ \frac{\mathcal{E}_2}{M_2} &= \frac{D}{N_2} - \frac{7}{6} & \frac{\mathcal{E}_5}{M_5} &= \frac{D}{N_5} - \frac{11}{6} \\ \frac{\mathcal{E}_3}{M_3} &= \frac{D}{N_3} - \frac{4}{3} & \frac{\mathcal{E}_6}{M_6} &= \frac{D}{N_6} - \frac{5}{2} \end{aligned}$$

A minimum value of  $\mathcal{E}/M$  can be established from these equations by comparing all the available values of  $N$  at each value of  $D$  under consideration. Since these equations are linear and easily plotted, the result was achieved graphically to illustrate more clearly what is being attempted. This, however, is not necessary and solution by computer would yield a desired value for  $D$  more quickly. The indicated equations are plotted in Figure 12. It is apparent from these curves that  $D = 15$  minimizes the maximum error  $\mathcal{E}$  in the region of interest. The available values of design  $K$  that should be used can now be determined from the slopes of the curves establishing a minimum  $\mathcal{E}$ . These follow and are designated code 6.

$$K = D/N_0$$

where  $N_0$  is the slope resulting in a minimum  $\mathcal{E}$  at  $D = 15$ .

## Coded-Linear-Array Antenna

Therefore

$$K = 1, 15/13, 15/11, 3/2, 15/8, \text{ and } 5/2.$$

The code positions and amplitude weightings for this code were obtained from (7) and are shown in Figure 13. The amplitude weightings assume three levels and the actual number of element positions reduce from 64 to 44, which are significantly fewer. The corresponding field strength pattern for this code is shown in Figure 14. Note that this antenna pattern approximates very closely the plot of code 4 in Figure 7. In essence, code 6 is a

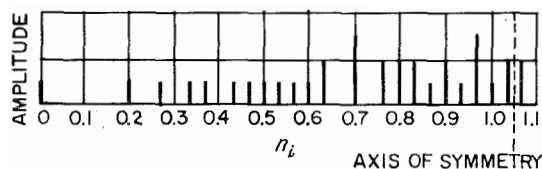

Figure 13—Space positions of elements and their excitation amplitudes for code 6.  $K = 1, 15/13, 15/11, 3/2, 15/8, \text{ and } 5/2$ .  $D = 15$ . A mirror image of the figure exists to the right of the axis of symmetry.

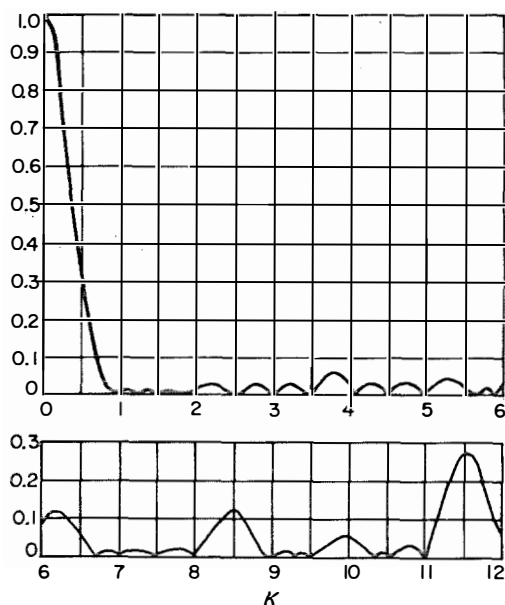

Figure 14—Normalized field strength pattern for code 6.  $K = 1, 15/13, 15/11, 3/2, 15/8, \text{ and } 5/2$ .  $K_{\max} = 6$ .  $D = 15$ . This curve is near optimum up to  $K = 6$ .

better match than code 5 to the optimum result, even though some of the lobes are slightly greater than for code 5.

## 5. Conclusion

A method has been proposed that uses coded spacings in designing array antennas. The technique is readily adaptable to force the code positions into preselected slot spacings. Although the design procedure could result in several digitized amplitudes, the number of different levels is generally small. A final design can approach an optimum condition as closely as desired, depending on how complex a system is acceptable. In addition, lobes adjacent to the main beam are more-easily suppressed than lobes farther away, permitting a near-optimum over-all antenna beamwidth pattern to be realized. That is, the product of the space-factor gain pattern by the individual-element gain pattern can approach a uniform distribution of the side-lobe levels.

## 6. Acknowledgments

The author wishes to express his appreciation to Messrs. M. Press, L. Cardone, and G. J. Peters for their encouragement and constructive criticism, and to Mr. R. Vachss and his staff for writing the computer programs required in the analysis. He also extends thanks to Professor G. Goudet for valuable suggestions relating to the final manuscript.

## 7. References

1. D. D. King, R. F. Packard, and R. K. Thomas, "Unequally-Spaced, Broad-Band Antenna Arrays," *IRE Transactions on Antennas and Propagation*, volume AP-8, number 4, pages 380-384; July 1960.
2. Roger F. Harrington, "Sidelobe Reduction by Nonuniform Element Spacing," *IRE Transactions on Antennas and Propagation*, volume AP-9, number 2, pages 187-192; March 1961.



3. Frank S. Gutleber, "A Space-Coded Linear-Array Antenna," Eighth Annual East Coast Conference on Aerospace and Navigational Electronics, 1961.

**8. Appendix**

**8.1 DERIVATION ILLUSTRATING THAT ALL DESIGN ZEROS EXIST IN A FINAL DESIGN**

Each set or pair of elements  $n_i, n_j$  forcing a null at  $K = a$  or  $\psi = \psi_0$  satisfies the following.

$$n_j = n_i + \frac{1}{2a} = n_i + \frac{\pi}{\psi_0} \tag{28}$$

A new element must be added for each of these to obtain an additional zero at  $K = b$  or  $\psi = \psi_0'$  according to the following relations.

$$n_i' = n_i + \frac{1}{2b} = n_i + \frac{\pi}{\psi_0'} \tag{29}$$

$$n_j' = n_j + \frac{1}{2b} = n_j + \frac{\pi}{\psi_0'} \tag{30}$$

Dividing (29) by (30) and rearranging the terms yields

$$n_j' - n_i' = n_j - n_i \tag{31}$$

Substituting (28) for  $(n_j - n_i)$  results in

$$n_j'\psi_0 = n_i'\psi_0 + \pi \tag{32}$$

which proves that each new set or pair would be 180 degrees out of phase at the original design value of  $K$ , thereby retaining all the original zeros as the design progresses.

**8.2 DERIVATION ILLUSTRATING THAT ZEROS RESULT AT ALL ODD INTEGERS TIMES DESIGN  $K$  VALUES**

For any specific design null  $K = K_0$ , the following condition exists between two cancelling vectors.

$$n'2\pi K_0 = n2\pi K_0 + \pi \tag{33}$$

However, the two vectors will also cancel for any value of  $K$  (other than  $K = K_0$ ) where

their arguments differ by any odd integral multiple of 180 degrees.

$$n'2\pi K = n2\pi K_0 + M\pi \tag{34}$$

where  $M =$  any odd integer, which results in a null point. Rearranging (33) and (34)

$$2(n' - n)K_0 = 1 \tag{35}$$

$$2(n' - n)K = M \tag{36}$$

Dividing (35) by (36) yields

$$K = MK_0$$

which verifies that nulls exist at the products of all odd integers by the design values of  $K$ .

**8.3 DERIVATION OF RELATIONSHIPS RESULTING IN COINCIDENCE BETWEEN CODED SPACED ELEMENTS**

A general code position can be represented by

$$n_i = \sum^{\text{all } j} \frac{1}{2K_j} \tag{37}$$

where  $\sum^{\text{all } j}$  signifies the summation of all values of desired  $K$  that are present in establishing the position  $n_i$ . This can consist of 1, all, or any combination of the values of  $K$  making up the complete code.

Since

$$K_j = \frac{D}{N_j} \tag{38}$$

where  $D =$  a constant, therefore

$$n_i = \sum^{\text{all } j} \frac{N_j}{2D} \tag{39}$$

Representing a different code element position by

$$n_i' = \sum^{\text{all } j'} \frac{N_j'}{2D} \tag{40}$$

coincidence will occur between these two elements when  $n_i = n_i'$ , or when

$$\sum^{\text{all } j} N_j = \sum^{\text{all } j'} N_j' \tag{41}$$

## Coded-Linear-Array Antenna

This result demonstrates that coincidence occurs between code positions when the sum of any combination of  $N_j$  is equal to the sum of any combination of  $N_j'$ . In general, there will be coincidence for any number of different combinations giving the same sum.

### 8.4 DERIVATION OF DIFFERENCE ERROR BETWEEN DESIRED AND AVAILABLE $K$ VALUES AS A FUNCTION OF $D$

The available values of  $K$  ( $K_a$ ) are given by

$$K_a = D/N \quad (42)$$

where

$D$  = an integer in some region of interest

$N$  = any integer with the restriction that  $N_{\max} = D$ .

The desired values of  $K$  ( $K_d$ ) generally differ from the available values of  $K$  by some error  $\mathcal{E}_0$  because  $D$  and  $N$  can assume only integer values over some restricted range. That is

$$K_a = K_d + \mathcal{E}_0 = D/N. \quad (43)$$

The desired zero points will differ from the available zero points by

$$MK_a = MK_d + M\mathcal{E}_0 = MD/N \quad (44)$$

where

$M$  = any odd integer

$MK_a$  = corresponds to all the available zero points

$MK_d$  = corresponds to all the desired zero points

$M\mathcal{E}_0 = \mathcal{E}$

= the total error resulting from the difference between an available and a desired zero point.

Rearranging (44) yields

$$\mathcal{E} = M \left( \frac{D}{N} - K_d \right). \quad (45)$$

This results in the following set of equations for  $n$  values of  $K_d$ .

$$\begin{aligned} \mathcal{E}_1 &= M_1 \left( \frac{D}{N_1} - K_{d1} \right) \\ \mathcal{E}_2 &= M_2 \left( \frac{D}{N_2} - K_{d2} \right) \\ &\vdots \\ \mathcal{E}_i &= M_i \left( \frac{D}{N_i} - K_{di} \right) \\ &\vdots \\ \mathcal{E}_n &= M_n \left( \frac{D}{N_n} - K_{dn} \right). \end{aligned} \quad (46)$$

Minimizing the maximum value of  $\mathcal{E}_i$  or  $\mathcal{E}_i/\gamma_i$  in the above set of equations will correspond to a best-match condition.

**Frank S. Gutleber** was born in Paterson, New Jersey, on 19 April 1929. In 1952, he received a B.S. degree, and in 1957, an M.S. degree (cum laude) in electrical engineering from Newark College.

From 1952 to 1954, he served with the United States Army Signal Corps where he was involved in the design and development of synchronizing networks, pulse generators, line-type pulse modulators for radar, and measur-

ing techniques. He joined ITT Federal Laboratories in 1952 and returned in 1954 after his service in the Signal Corps. He is presently engaged in an applied-research study on satellite communications.

Mr. Gutleber is a member of Eta Kappa Nu and a Member of the Institute of Electrical and Electronics Engineers. A patent on a multiplexed signaling system has been issued to him.

# Choice of a Telephone Switching System

E. M. DELORAINE

Laboratoire Central de Télécommunications; Paris, France

## 1. Introduction

The importance of selecting a switching system well adapted to meeting both present and future requirements of telephone service is great and may well have far-reaching consequences. It affects the subscriber, operating authority, and manufacturer as well as influencing the quality of service, adaptability to new demands, and the over-all economy of the telephone system.

The trend in the principal countries of the world is to automatic operation, though only a few have reached the ultimate point of 100 percent. The data available indicates that substantial operating economy results from automatization.

The laws followed in the evolution of telephone traffic, as presented elsewhere in this issue by the author, permit further large increases in telephone plant to be forecast. It is timely to consider, therefore, whether existing switching systems are capable of meeting the challenge or whether a search for new concepts is justified. It must be recognized that the selection of an automatic switching system to be incorporated in the existing telephone network is a controversial subject.

In comparison, subscriber sets, printers, wire lines (either on poles or in cables), radio links, coaxial cables, or carrier systems, have technically more in common on a worldwide basis than the major automatic switching systems in use or under development.

It is useful to analyze the causes that create this complex situation to see to what extent it may be possible by technical, economic, or service considerations to justify a specific trend in this field of telecommunications.

Switched telecommunication networks, until recently, have been predominantly telephone networks, the only other form of switched communication being telegraph, which is handled on separate networks in the majority of cases. Consequently, automatic switching systems have been designed to switch telephone

conversations and were adapted to switch telegraph traffic.

When reviewing the considerable literature that covers the most-extensively used telephone switching systems, we find that these systems can be classified in perhaps 10 families, some large, some more modest. Each family divides in turn into several principal systems that differ rather widely in their concept and field of application. In all, one can certainly list more than 50 clearly identified switching systems in use.

It is true that these systems may use the same basic apparatus. However, even based on apparatus alone, one can list at least 20 different systems in use.

Most switching-system descriptions, especially those dealing with more-recent designs, tend to focus attention on the mechanical characteristics of electromechanical switching or control devices, or lately on electronic components that perform their functions, instead of on the features and costs of the systems. General requirements are left in the background although these justifiably could be considered and analyzed first.

These primary considerations may be conveniently divided into 3 groups as follows.

(A) Those of direct interest to the subscriber, involving his needs and desires as a telephone user.

(B) Those of direct concern to the operating authority.

(C) Those that concern principally the developer, manufacturer, and installer of equipments or lines.

## 2. Subscriber

Considering the telephone user first, it is clear that he is developing definite views and requirements based on progressively acquired experience.

## Choice of a Telephone Switching System

The first evolution in the user's concept of telephone service is not to differentiate any longer between local calls and long-distance calls. The telephone subscriber today expects all calls, far or near, to be made by direct dialing and wishes to reach the called party within seconds. Calls involving manual operations (except perhaps for the longest world circuits) appear to him destined to be replaced sooner or later by calls established by direct dialing. In other words, the subscriber has built the concept, at least on a national basis, that the telephone system forms one integrated network, and soon he will extend this notion to larger areas, such as the whole of Western Europe.

A second reaction of the telephone user is that after the novelty of national or international subscriber dialing wears off, customers in some countries may object to dialing 10 to 15 successive digits, which requires a minimum of 10 seconds or more before the destination can be reached. One can foresee a desire to have this number of digits reduced to a strict minimum and, as time goes on, to have an instrument with a fast push-button digit sender. This may be coupled with a request for simpler methods to reach subscribers called most frequently.

The subscriber expects to converse with any person as though they both were in the same room. He will not indefinitely accept poor circuits that compel frequent repetitions; he expects the circuits to be noiseless regardless of distance or complexity of the call. The more-experienced subscriber has learned that the quality of very-long-distance calls can be excellent and that some of the conversations over limited distances can be very difficult. He does not understand, justifiably, why it is harder to converse from near than afar.

The subscriber will be pleased if his instrument can be made smaller, lighter, and more attractive; if he can adjust the loudness of the bell or other calling device; and if various designs are available that are specifically suited for office, home, and other use. Some subscribers

will wish to replace the standard instruments with those having loudspeakers and amplifiers to allow handsfree operation.

The subscriber will appreciate also, in the not-too-distant future, such additional facilities as the automatic transfer of a call to another telephone if the called number does not answer or is busy, the possibility of an automatic return call to a subscriber from a called party who was busy, the possibility of bringing a third party into a conversation, et cetera.

If the subscriber must know the cost of each call immediately on completion, this service must be made available.

### 3. Operating Authority

The operating authority, besides considering the subscribers' views, has many additional problems not apparent to the individual subscriber.

It is well-established that it is possible in a telephone network to decrease the cost or complexity of one of the constituent parts, such as the automatic-switching offices, if at the same time one is willing to increase the cost or complexity of another part of the network, for instance the density and number of interoffice junctions.

In consequence, the optimization of the major parts of a network and its effect on the rest of the system must be included in the over-all design.

A second factor of great significance in the choice of a system is the probable rate of growth of telephone traffic in the next decade. A simplified picture of telephone density today is that half of the world's telephones are in the United States, one quarter in Western Europe, and the last quarter spread over the rest of the world.

This indicates that countries outside the United States can expect a continued rapid increase in number and use of telephones. Figures show that the rate of increase of automobiles in

Europe is higher than that of telephones; also that there is greater development of electricity distribution than of telephones. In view of the expected exponential increase in telephone traffic, it is probable that in most countries in Europe, in South America, in Japan, et cetera, the unsatisfied demands for telephone service that are expressed only in part by actual requests will increase further unless plans are made to add new facilities at a rate capable of meeting the increase in traffic as well as these requests for new service.

It is difficult to foresee with accuracy where the demand and the traffic will develop fastest, how much additional demand may result from services such as data transmission, and what the characteristics of such data transmission will be. The selected system must, therefore, provide a flexible configuration of networks capable of rapid expansion when and where required, without undue delay or waste of money.

The highest degree of service reliability must be maintained despite unavoidable difficulties or breakdowns from causes entirely beyond control of the telephone operating authority. In consequence the network should be organized so that a local fault will affect only a minimum of calls. Abnormal traffic loads in given directions or areas may be caused by local events. Automatic alternative routing of calls is helpful in such situations.

The accounting of calls and submission of accurate bills to the subscriber are a responsibility of the operating authority. While most subscribers need but few details on their telephone bills, some require a full breakdown, for instance in all cases when each call is paid for separately, and for the most-expensive calls even if placed from residential telephones. The systems used must be adapted to supply such accounting information as may be required.

Another element is the evolution of services to be performed over what was originally the telephone network. It is significant that the words "telephone and telegraph," so frequently asso-

ciated in the literature and in the names of companies or government departments, tend to be replaced by the single word "telecommunications." This recognizes that the original problem of handling telephone traffic has now become broader. It involves switching other types of information such as data in a number of forms. We can foresee having to switch data messages possessing particular characteristics; one already experienced is the frequent transmission of very-short messages for which the switching and message-transmission times may be comparable. Such is the case for the growing service of seat reservations for airlines. This additional consideration points to the importance of rapid switching and signaling. Post-dialing delay, the interval between completion of dialing and start of ringing tone, cannot be ignored. The acceptable limits on line noises must also be modified; pulse noise, which has little effect on conversation, interferes seriously with the correct transmission of data.

One may have to provide and switch data channels having characteristics that differ from telephone channels, sometimes involving narrower bands of frequencies, but more frequently requiring wider frequency bands than those of telephony.

It is hardly necessary to point out that estimates have been made by well-informed telecommunication officials that data traffic within a limited number of years may compare in volume to telephone traffic. While today it is a little hard to visualize where all this data traffic would originate, one will not make a mistake in assuming that this type of traffic will grow rapidly over the next two decades and that the corresponding problems should be taken into consideration without delay.

#### 4. Manufacturer

The designer, manufacturer, and installer of telecommunication equipments and lines have in turn their own problems, several of which concern switching systems.

## Choice of a Telephone Switching System

A first consideration is continuity of design, at least as far as it applies to apparatus and assemblies. The cost of designing, testing, and tooling is so high—special machinery being so expensive—that it takes many years to amortize such costs. Furthermore, it is a common experience that if a design remains stable, costs of a system will decrease and quality will improve year after year. The necessary time is thus obtained to develop and introduce many improvements in design, production, testing, and installation, some of which may appear minor but will in total have a real effect on the over-all cost and on the quality of operation of the system. In consequence any design adopted must be of such character that it can be used extensively and be likely to last for many years.

A second consideration is that, at least outside the United States, the production of telephone equipments takes place in an increasing number of locations. National manufacture continues to be the aim in many countries that are not yet greatly involved in the production of automatic telephone exchanges. Therefore it is desirable that a design for manufacture be capable of relatively easy export to countries with limited manufacturing skill, and that this should involve plant and tooling expenditures compatible with the volume of production. Apparatus design must avoid the need for highly accurate machined parts, complicated mechanisms, delicate testing, and critical adjustments.

Another requirement is that as much of the final equipment as possible should be finished in the factory before shipment, as work done on site tends to be expensive and is more difficult to supervise, especially when dealing with export orders. Standard packaged installations, if acceptable to the customer, are a promising way to achieve low cost combined with high-class performance. Skilled installers are few, and their task must be simplified by supplying large units fully wired and tested.

When installed and tested, the exchanges should operate with a minimum of attention. If attention is required, the location and nature

of the trouble should be indicated by automatic means.

Reliability of apparatus is basic in both mechanical and electrical operation. Good telephone service essentially requires good circuit design and highly reliable contacts.

It is desirable also that the designs be such that a false operation or a failure to operate of one or a few units cannot create a serious disturbance in the operation of the whole office. Recurrent testing and alternative paths within the exchange are helpful in this direction.

### 5. Direct and Indirect Systems

Direct switching systems operate on the principle that each dialed digit actuates directly one switching stage. In many systems, the last two digits correspond to a single switching stage. The time between dialing successive digits is used to find a free outlet to the next selector stage. The number of stages of selection will correspond with the number of digits dialed, except that digits not needed for some paths may be absorbed. The direct systems are consequently also called stage-by-stage selection systems.

By far the greatest majority of direct switching systems are of the step-by-step class, characterized by the up-and-around step-by-step switch. They are not restricted to this switch; the original *R6* system used in France and North Africa in 1927 operated as a direct system with single-motion switches. It was modified later to operate as an indirect system. Crossbar switches with associated controls are used in direct switching systems, each crossbar selector corresponding to one stage of selection.

In other words, in direct switching systems the subscriber, when operating his dial, controls directly, and so to speak personally, the operation of the successive stages of selection in the network. If for any reason there were more digits in the dialed number than stages of selection, these extra digits are unnecessary and must be absorbed.

Many important consequences result from this method of operation.

There is a direct relation between the code being dialed by the subscriber and the design of the selectors used; in particular the speed of the selectors controls the speed at which the dial or sender can operate, and the time necessary for selection of a free outlet controls the interdigital time in most cases.

In these direct systems, as dialing starts, selection starts also, and the progress of the call, often over expensive trunks, takes place at the comparatively low dialing speed. The system does not know during the process the final destination of the call, although this is the objective of the whole program. In case of failure in the process, mainly caused by one stage finding all accessible outlets busy, it is not practical to have the switching equipment try again by itself via another route within or outside the office, as the data characterizing the called number has been spread over the network and cannot be assembled again. The subscriber will have to do this himself by dialing all digits again as many times as necessary.

Each selector has access to only a limited number of outlets. Therefore, to avoid too many incomplete calls because all such outlets are busy on interoffice calls, it is necessary to have more trunks than if every switch had access to a larger group of trunks.

In direct systems, each digit of a subscriber's number corresponds to a switching direction. Consequently many digits are not used, as offices cannot be designed to have exactly 100, 1000, or 10 000 subscribers. Alternatively, if all numbers in a 1000-line office are used and more telephones are needed in the area, one cannot borrow numbers from another office. In practice in most European networks of this type, not more than 15 percent of the total possible subscriber numbers are used.

In a network involving a number of offices, one does not need a uniform number of stages of selection to reach any telephone; it depends

mainly on the size of the office. Thus the number of digits dialed may vary between wide limits in some plans, depending on which office is called. In other plans, excess digits are absorbed.

The broad concept of direct stage-by-stage control has the important advantage of simplicity, but has many serious limitations that can be avoided by the indirect system. In fact, few networks are now of the purely direct type, but most use at least a mixture of direct and indirect methods of switching.

Indirect operation is based to some extent on the characteristics of manual operation, in that the identification of the station dialed by the calling subscriber and the series of steps that follow are not one single process, but two independent operations. This is done by introducing—between the request delivered by the subscriber in the form of a code characteristic of the called party and what is done about it—elements of logic, of decision, and of adaptation to conditions and circumstances totally lacking in the direct system.

This indirect method means that when a subscriber is calling, receipt of the dial tone indicates that he is connected temporarily to common equipment, that is, to equipment accessible in sequence to many subscribers. This equipment is capable of receiving the code transmitted by him, translating such code into a sequence of orders that depend on conditions that become known to this common equipment as a result of a series of appropriate tests. These orders are transmitted usually by fast signaling over the junctions or the long-distance trunks. It is possible to design this equipment so that the subscriber may send codes requesting additional operations, such as transfer, recall, third party on the line, or transfer of a call to another telephone in case of absence.

It is not necessary that all subscribers have the same instrument for sending the code of the wanted party. Subscribers can have a normal dial, a high-speed dial, a push-button digit sender, or some other apparatus, as the signals

## Choice of a Telephone Switching System

will be translated into a new signaling code that is more suitable for selection in the register or, in some otherwise direct systems, in a special limited-storage device. This new signaling code can be extremely fast and save time on the expensive long lines. Nowadays the trend is clearly toward multifrequency codes capable of about 10 times the signaling speed of standard dialed impulses.

It would be advantageous and avoid many complications if this second signaling code used between the registers of the network were standardized.

The general problem of future signaling methods in Europe between registers has been dealt with very thoroughly by den Hertog<sup>1</sup>.

The translation just mentioned is an important advantage of the indirect system. It permits numbering the subscribers in the network independently of their location, of the size of the various offices, and up to a point, of the growth in the number of telephones. In a large network, the number of digits characterizing a subscriber can be the minimum that will still accommodate the planned capacity of the network, and all such numbers can be used.

In indirect systems, if network growth makes it compulsory to add another digit to all subscribers' numbers, this increase in the number of digits to be dialed does not result in a corresponding increase in the number of selection stages for reaching subscribers at existing offices. If the same result is to be achieved with direct systems, either the digit added to existing numbers must be absorbed, or the subscribers' numbers at existing offices may remain unchanged and an increased number of digits dialed only for additional offices.

The register may be equipped to provide information of the codes of both the calling and

called subscribers for billing and other purposes.

An important characteristic of indirect systems is that information in the register may be transferred to one or more common control equipments, which in turn can test and operate not only one but several stages of selection in parallel. This common control equipment can determine which path is available within the multiple stages of the office and select one free path. This combined selection appreciably reduces the number of internal links.

Something similar can be done with interoffice trunks or toll lines, up to the point where each incoming line has access to all trunks in a given direction. This again reduces the number of trunks required. The register, in combination with these common equipments, can attempt to select a free trunk—if necessary, successively over several possible routes, some direct and others via an intermediate office. This again involves a saving in the number of interoffice junctions or toll lines and assures continued traffic even during breakdown of one or all trunks of one route.

The employment of common equipment considerably facilitates the use of information on the condition or class of both the calling and called lines, either to change the routing of the call, to control charges, to permit or block access to certain groups of trunks, et cetera.

Several of the additional features mentioned can be associated with the common equipment; some of the more-elaborate ones may require program and memory units to receive the orders and translate them to operate appropriate controls. It is easy to visualize that combinations of electromagnetic and electronic equipment may be adapted to perform some of these operations.

Registers and common equipment, of course, are released as soon as their particular functions are completed.

Present complete networks employ all three possible combinations: pure direct, mixed indirect and direct, and pure indirect systems.

---

<sup>1</sup> M. den Hertog, "Interregister Multifrequency-Code Signalling for Telephone Switching in Europe," *Electrical Communication*, volume 38, number 1, pages 130-164; 1963.



It may be said that there are no longer any pure direct systems in the largest telephone networks. The two principal step-by-step networks in Europe are in England and in Germany, and are a combination of direct and indirect switching. In the United States, about half of the presently installed lines use step-by-step switching; new installations are predominately crossbar with indirect operation.

Step-by-step offices operate with direct selection within the offices and with indirect selection using registers if medium or long inter-office trunks are involved.

Numerous other countries in Europe have operated for many years with pure indirect switching systems. In France, Belgium, Spain, Norway, and Denmark, all offices use registers. Some other countries combine offices with and without registers in the same network. Such is the case in Switzerland, Holland, Sweden, and Italy, but here the automatic toll network is based on indirect switching.

### 6. Open and Closed Numbering Systems

It is interesting to see the effect of the choice of one of these 3 systems on subscriber numbering, on the number of digits required to reach a wanted party in a given area, and on the expansion of a particular network.

In areas employing direct switching systems, open numbering in which a variable number of digits is used, tending to permit a minimum number of digits to be assigned in each local area, is usually employed inside each zone served by one toll center. In general, open numbering is applied to areas where the local subscriber is restricted to calls within the local area. Calls between different local areas then require the addition of a prefix.

In areas employing indirect systems, it is normal to use closed numbering based on a fixed number of digits that may require more than the minimum number of digits in some localities but all subscribers are identified by a

fixed number of digits irrespective of the origin of the call. Closed numbering applies to areas that may extend over a whole country.

Open numbering is preferred for direct systems because the number of digits then required for establishing a local call is determined exclusively by the number of subscribers in each locality. This may vary between a small number (say 3 digits for an exchange with a maximum of 900 numbers) and a large number (say 6 or 7 digits for a large local area). In this manner it is possible to restrict the number of selectors involved in a local call without resorting to digit absorption.

Closed numbering is chosen for indirect systems because this permits distributing the total numbering capacity of the zone served by one toll center among a number of localities by the use of register translators. It allows the use of uniform numbers for all subscribers, the number of digits being dictated by the required numbering capacity of the whole zone. This can be done without increasing the number of selectors required for local calls at each locality beyond the number required for reaching all local numbers.

A consequence of using open numbering is that each locality must be identified by an individual toll prefix. On the other hand, with closed numbering, each zone consisting of several local areas is identified by a single toll prefix. Consequently, with open numbering, the number of toll prefixes required may be 100 or more times larger than with closed numbering and each will contain 2 or 3 digits more than is necessary with closed numbering.

With open numbering, the local subscriber's number must be preceded by a toll prefix for all calls leaving the locality, even those directed to neighboring localities in the same zone.

With closed numbering, uniform numbering is employed throughout a zone and these numbers are preceded by a toll prefix only for toll calls leaving the home zone and served by another toll center.

## Choice of a Telephone Switching System

As a consequence, it has been found that open numbering leads to national numbers, that is, those constituted by toll prefix and local number, having 2 or 3 more digits than would be needed under the same circumstances with closed numbering. Furthermore, the number of calls requiring use of the complete national number is considerably higher with open numbering than with closed numbering.

As an extreme case, if direct switching were used exclusively (including the toll network), the whole toll network would have to be established on a decimal basis, which would tend to increase the number of toll digits required because of the loss of numbering capacity through non-usage.

All this leads to a larger number of digits being required with direct systems than with indirect systems, and a concomitant increase in the number of selecting stages with direct systems.

In the 3 systems discussed above, it must be possible to reach any subscriber by either the local or the national number no matter how many toll offices may be engaged in the connection.

### 7. Apparatus and Signaling

With the system background already covered, the relative merits of various types of apparatus may be discussed. It may be concluded that all 3 types of networks should be considered, although the evidence shows that the indirect type will progressively gain in relative importance.

Apparatus may be designed primarily for and work best in either direct or in indirect systems. This is apparently what happened in the United States, where direct-type exchanges use the classic step-by-step switch and the indirect type, after an early design using panel-type switches, now is designed with crossbar switches.

It is significant, however, that crossbar exchanges in the Bell System are progressively taking the lion's share of new installations,

while step-by-step installations are almost-entirely limited to extensions of existing step-by-step offices.

It appears unnecessary to discuss in detail the limitations of step-by-step up-and-around switches. Their most-objectionable features are low operating speed, poor contacts, lack of flexibility, and limited number of outlets per switch.

As early as 1927, one of our companies decided to replace the up-and-around switch with a single-motion rotary switch (*R6* system). In 1913, another of our companies introduced the rotary system, which has since been used extensively.

It is now universally recognized that new apparatus should provide precious-metal contacts, at least for the speech path. One is therefore impelled to consider relay-type pressure contacts. Speech quality may also be improved by using 4-wire speech circuits, so new switches must provide for 4 conductors.

The selector and associated relays must not create noise in the speech circuits, either directly or by induction. Any vibration of the contacts that results in large resistance variations must be avoided. Breaking high currents, operation of heavy relays, and any friction contact in the selector are critical from this point of view.

Speed of selection is a basic requirement and the general trend is toward faster switching processes. This is due in part to the increased use of high-speed signaling within and between offices.

With these considerations in mind, one will appreciate that any redesign of the presently used rotary and up-and-around switches must envisage both precious-metal speech contacts and a substantial increase in operating speed, if the ultimate system is to balance signaling time and switching time.

Low speed becomes a very-serious handicap in complex networks involving several offices in one connection, as connections cannot be set up

faster than the switches operate. The speed of selection becomes more important as the network grows in size and complexity. In fact, one would like to have switches with such speed of operation that in association with high-speed signaling, the time for all switched connections remains essentially the same. The selecting time considered adequate nowadays is in terms of milliseconds, and selectors requiring a full second or more to operate no longer fulfill modern requirements.

It is desirable to avoid switch designs involving parts machined with high accuracy and complete motions started and stopped suddenly with precision by highly sensitive high-speed relays.

From this background, it is easy to understand the increasing success of crossbar switches. They meet the requirements listed above, such as high quality of contacts, a reasonable number of outlets, flexibility in grouping these outlets, speed of operation, and uniformity of selecting time. They also have one considerable added advantage, namely their mechanical simplicity. The crossbar switch involves only two very-simple operations, the placing of a light selecting finger in one of two possible positions and the closing of the relay contacts thus selected. This apparatus also meets the requirements for manufacturing simplicity, ease of installation, and very-limited maintenance.

The crossbar switch can be used for direct systems, that is, systems with stage-by-stage selection, one stage per digit. A few auxiliary and counting relays would be associated with each stage of selection. Crossbar equipment can be adapted to extensions of step-by-step offices. The crossbar switch can be associated also with register and control circuits to form various types of offices. The more-elaborate offices include a common control capable of setting multiple selection over several stages. The crossbar switch can be used in the large and medium size exchanges, also in private branch exchanges down to 24 lines, below which size it is no longer economical.

### 8. Centralized Control

Numerous studies have been made during the past 10 years of the merits of a partial or extensive introduction of electronic components and circuits in automatic offices. A trend toward more central control is evident. This is to be expected as electronic circuits have the merit of speed, and with higher speed, circuits can be designed to handle more operations in a given time.

These future central control systems, as visualized today, are much closer in concept and philosophy to the present crossbar exchanges using registers and common controls, than to exchanges following the principles of direct stage-by-stage selection. The evolution from electromechanical to mixed electronic-and-electromechanical exchanges, when it takes place, will be greatly facilitated by the prior introduction on a large scale of register and common-control crossbar exchanges.

### 9. Conclusion

The considerations enumerated above indicate that future switching systems will be based with advantage on what has been termed the indirect method of switching, combined with extensive use of centralized control. In consequence, the network numbering will tend toward the closed type. Primary consideration must be given to the extending of existing central offices, which is an involved problem.

**E. M. Deloraine.** Biography appears on page 276.

# World's Telephones—1962\*

The net gain of 8.3 million in world telephones in 1961 was exceeded in the past only by the gain in 1959 and represented an increase of 5.9 percent. Countries other than the United States accounted for 63 percent of the gain—the highest proportion in a great many years. For the first time, automatic telephones reached a proportion of 90 percent of all telephones in the world.

Censuses during the period 1955–1964 are considered part of the World Censuses of 1960, sponsored by the United Nations. A number of countries have had either their first census, or their first in many years, and world population figures today are probably more accurate than ever before. In the bar graph at right, all the countries included in this report were listed in the order of their ratios of telephones to population. The list was divided into four parts, such that each part included exactly 25 percent of the estimated population of the

world. Then the percentages of world totals of telephones and territory were computed for each fourth and plotted on the chart. The enormous disparity in the distribution of telephones is evident and is responsible for correspondingly wide variation in development: for every ten thousand people in the top fourth, for example, there are 1824 telephones,

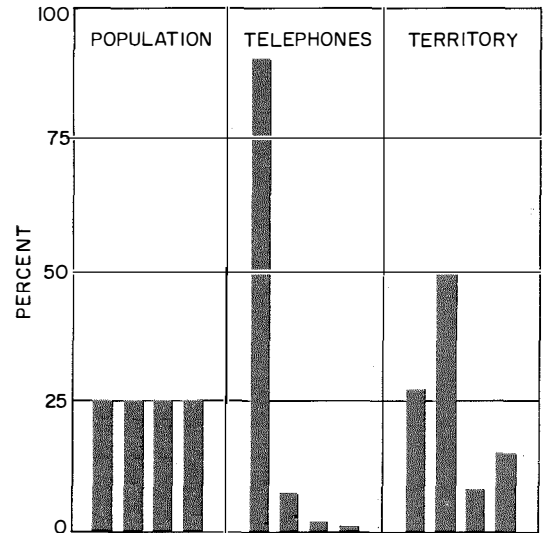

\* Abridgement from the 1962 issue of a booklet, "The World's Telephones," published yearly by the chief statistician's office of the American Telephone and Telegraph Company, New York, New York.

TABLE 1  
TELEPHONES IN CONTINENTAL AREAS—1 JANUARY 1962

Area	Total			Privately Operated <sup>1</sup>		Automatic	
	Number 1962	Percent of World	Per 100 Population	Number 1962	Percent of Total	Number 1962	Percent of Total
North America	83 186 400	55.5	41.0	82 175 000	98.8	80 340 000	96.6
Middle America	1 167 300	0.8	1.6	813 500	69.7	997 400	85.4
South America	3 475 500	2.3	2.3	1 654 400	47.6	3 033 300	87.3
Europe	46 377 000	30.9	7.7	7 975 400	17.2	39 888 800	86.0
Africa	2 081 800	1.4	0.8	27 800	1.3	1 553 000	74.6
Asia <sup>2</sup>	10 303 300	6.8	0.6	6 397 100	62.1	7 289 700	70.8
Oceania	3 408 700	2.3	20.2	255 600	7.5	2 719 400	79.8
World	150 000 000	100.0	4.9	99 298 800	66.2	135 821 600	90.5

(1) Necessarily the distinction in this classification is with respect to operation rather than ownership. In particular it is to be noted that systems that are government owned in whole or in part may be privately operated (for example, Italy

and Japan). The word "government" refers to nations, states, or municipalities.

(2) These data include allowances for the Asiatic parts of Turkey and the Union of Soviet Socialist Republics.

compared with only 8 in the bottom fourth. The proportionate distribution of territory

shows little relation to that of telephones in the four major divisions.

TABLE 2  
YEARLY TOTAL NUMBER OF TELEPHONES IN SERVICE

Area	1961	1960	1959	1958	1957	1952
North America	79 830 600	76 036 400	71 799 300	68 484 000	64 720 700	48 770 000
Middle America	1 075 900	1 008 000	910 800	835 900	772 800	593 700
South America	3 337 600	3 145 900	2 999 600	2 845 000	2 695 300	1 931 000
Europe	43 172 700	40 340 900	37 598 100	35 218 700	32 510 000	22 811 000
Africa	2 005 300	1 904 500	1 768 600	1 663 200	1 546 100	986 000
Asia <sup>1</sup>	9 053 400	8 110 000	6 855 700	6 062 500	5 229 500	3 121 300
Oceania	3 224 500	3 054 300	2 867 900	2 690 700	2 525 600	1 787 000
World	141 700 000	133 600 000	124 800 000	117 800 000	110 000 000	80 000 000

(1) These data include allowances for the Asiatic parts of Turkey and the Union of Soviet Socialist Republics.

TABLE 3  
TELEPHONES BY COUNTRIES AS OF 1 JANUARY 1962

Country or Area	Number of Telephones	Per 100 Population	Percent Automatic	Telephones by Type of Operation (1)	
				Private	Government
<b>NORTH AMERICA</b>					
Canada	6 020 000	32.66	89.0	5 069 000	951 000
Greenland	0	—	—	—	—
St. Pierre and Miquelon	397	7.94	0.0	0	397
United States (2, 3)	77 166 000	41.80	97.2	77 106 000	60 000
<b>MIDDLE AMERICA</b>					
Bahamas	13 236	12.14	98.9	416	12 820
Barbados	10 630	4.47	100.0	10 630	0
Bermuda	16 000	32.00	100.0	16 000	0
British Honduras	1 033	1.11	2.9	0	1 033
Canal Zone (4, 5)	8 113	36.88	100.0	0	8 113
Cayman Islands	32	0.36	0.0	0	32
Costa Rica	16 591	1.33	80.1	16 591	0
Cuba	208 217	3.02	92.5	0	208 217
Dominican Republic	21 466	0.68	93.6	21 076	390
El Salvador	18 001	0.71	50.0	0	18 001
Guadeloupe and Dependencies	3 947	1.41	0.0	0	3 947
Guatemala*	20 300	0.52	89.7	0	20 300
Haiti	4 400	0.12	86.0	0	4 400
Honduras	5 862	0.30	83.6	0	5 862
Jamaica	38 384	2.33	98.4	38 384	0
Leeward Islands					
Antigua	837	1.52	0.0	0	837
Montserrat	198	1.65	0.0	0	198
St. Kitts	400	0.69	0.0	0	400
Total	1 435	1.15	0.0	0	1 435

\* Estimated.

- (1) Necessarily the distinction in this classification is with respect to operation rather than ownership. In particular it is to be noted that systems that are government owned in whole or in part may be privately operated (for example, Italy and Japan). The word "government" refers to nations, states, or municipalities.
- (2) Data for the State of Alaska are included. Data for the State of Hawaii are included under Oceania, rather than here under North America.
- (3) The number shown as governmentally operated is estimated. More than half of such telephones are in the State of Alaska.
- (4) Data are as of 30 June 1961.

- (5) Data exclude telephone systems of the armed forces.
- (6) Data for the following countries are necessarily stated as of the latest date for which statistics are at hand:

Afghanistan	1 January 1955
Bulgaria	1 January 1948
China, Mainland	1 January 1948
Hungary	1 January 1957

- Those parts of the telephone system of China (Mainland) which are shown in the table as privately operated continued under such operation until 1949, when they came under government operation.
- (7) Data are as of 31 March 1962.

TABLE 3—Continued  
TELEPHONES BY COUNTRIES AS OF 1 JANUARY 1962—Continued

Country or Area	Number of Telephones	Per 100 Population	Percent Automatic	Telephones by Type of Operation (1)	
				Private	Government
Martinique	6 482	2.27	71.6	0	6 482
México	567 316	1.55	84.4	566 137	1 179
Netherlands Antilles	14 743	7.52	100.0	4 423	10 320
Nicaragua	9 261	0.60	63.6	0	9 261
Panamá	32 586	2.97	86.1	31 923	663
Puerto Rico	109 478	4.50	79.3	101 934	7 544
Trinidad and Tobago	31 681	3.62	90.3	0	31 681
Turks and Caicos Islands	130	2.17	65.4	85	45
Virgin Islands (United Kingdom)	31	0.39	0.0	0	31
Virgin Islands (United States)	4 283	12.60	0.0	4 283	0
Windward Islands:					
Dominica	677	1.11	0.0	0	677
Grenada	1 616	1.80	100.0	1 616	0
St. Lucia	819	0.94	68.6	0	819
St. Vincent	550	0.66	0.0	0	550
Total	3 662	1.14	59.5	1 616	2 046
SOUTH AMERICA					
Argentina	1 360 205	6.40	88.3	96 316	1 263 889
Bolivia	18 370	0.52	91.3	16 770	1 600
Brazil	1 046 621	1.42	83.0	991 849	54 772
British Guiana	9 066	1.54	91.2	0	9 066
Chile	203 315	2.58	79.3	202 265	1 050
Colombia	322 486	2.21	98.5	18 195	304 291
Ecuador	30 724	0.68	97.7	0	30 724
Falkland Islands and Dependencies	440	22.00	0.0	0	440
French Guiana	1 047	3.27	0.0	0	1 047
Paraguay	11 363	0.62	92.0	0	11 363
Peru	113 218	0.94	85.9	113 218	0
Surinam	5 849	2.00	95.9	0	5 849
Uruguay	137 063	4.74	78.6	0	137 063
Venezuela	215 774	2.72	96.6	215 774	0
EUROPE					
Albania*	6 000	0.36	50.0	0	6 000
Andorra*	200	2.22	0.0	0	200
Austria	750 309	10.60	94.3	0	750 309
Belgium	1 211 449	13.13	90.1	0	1 211 449
Bulgaria (6)	54 347	0.77	39.4	0	54 347
Channel Islands:					
Guernsey and Dependencies	13 248	28.13	52.9	0	13 248
Jersey	18 942	30.07	63.0	0	18 942
Total	32 190	29.26	58.8	0	32 190
Czechoslovakia	1 114 049	8.06	82.1	0	1 114 049
Denmark	1 132 259	24.28	57.6	1 002 184	130 075
Finland	654 167	14.61	83.0	470 352	183 815
France	4 648 896	10.07	80.7	0	4 648 896
Germany, Democratic Republic	1 366 199	8.00	96.1	0	1 366 199
Germany, Federal Republic (5)	6 508 664	11.50	99.7	0	6 508 664
Gibraltar	3 236	12.45	100.0	0	3 236
Greece	268 564	3.19	94.0	0	268 564
Hungary (6)	347 672	3.55	77.8	0	347 672
Iceland	42 154	23.41	72.0	0	42 154
Ireland	163 482	5.83	75.4	0	163 482
Italy	4 235 215	8.53	96.9	4 235 215	0
Liechtenstein	4 764	28.02	100.0	0	4 764
Luxemburg	57 815	18.24	97.7	0	57 815
Malta and Gozo (7)	17 096	5.18	65.0	0	17 096
Monaco*	9 000	40.91	100.0	0	9 000
Netherlands	1 740 110	14.85	99.9	0	1 740 110
Norway	773 421	21.33	73.4	46 384	727 037
Poland	957 022	3.18	78.2	0	957 022
Portugal	426 787	4.62	75.4	297 794	128 993
Rumania	217 000	1.16	75.0	0	217 000
San Marino	896	5.27	100.0	896	0
Spain	1 949 156	6.37	78.8	1 922 515	26 641
Sweden	2 904 173	38.51	91.9	0	2 904 173
Switzerland	1 761 946	31.90	100.0	0	1 761 946
Turkey	254 535	0.89	83.9	0	254 535
Union Soviet Socialist Republics	5 119 061	2.33	58.4	0	5 119 061
United Kingdom (7)	8 609 000	16.25	85.0	0	8 609 000
Yugoslavia	276 487	1.46	80.9	0	276 487

TABLE 3—Continued  
TELEPHONES BY COUNTRIES AS OF 1 JANUARY 1962—Continued

Country or Area	Number of Telephones	Per 100 Population	Percent Automatic	Telephones by Type of Operation (1)	
				Private	Government
<b>AFRICA</b>					
Algeria	205 061	1.81	84.1	0	205 061
Angola	9 883	0.20	66.7	0	9 883
Ascension Island (5)	64	9.58	78.1	64	0
Basutoland	983	0.14	1.6	0	983
Bechuanaland	976	0.28	0.0	0	976
Burundi	2 242	0.10	93.8	0	2 242
Cameroons*	7 800	0.19	76.0	0	7 800
Cape Verde Islands	239	0.11	74.9	0	239
Central African Republic	1 529	0.10	0.0	0	1 529
Chad	1 907	0.07	0.0	0	1 907
Comoro Islands*	50	0.03	0.0	0	50
Congo (Brazzaville)	5 706	0.63	90.6	0	5 706
Congo (Léopoldville)*	30 000	0.21	85.0	0	30 000
Dahomey	2 150	0.10	69.8	0	2 150
Egypt, United Arab Republic*	245 200	0.91	82.0	0	245 200
Ethiopia	12 628	0.06	80.3	0	12 628
Gabon	2 068	0.45	0.0	0	2 068
Gambia*	700	0.24	99.0	0	700
Ghana	26 234	0.37	68.7	0	26 234
Guinea*	4 000	0.13	72.0	0	4 000
Ifni	135	0.24	0.0	0	135
Ivory Coast	9 199	0.28	78.8	0	9 199
Kenya	42 467	0.58	81.8	0	42 467
Liberia	2 300	0.17	100.0	600	1 700
Libya	12 357	1.01	51.9	0	12 357
Malagasy	14 549	0.26	64.6	0	14 549
Mali*	3 000	0.07	65.0	0	3 000
Mauritania*	300	0.04	0.0	0	300
Mauritius and Dependencies	9 481	1.42	8.7	0	9 481
Morocco	130 989	1.08	88.9	17 931	113 058
Mozambique	13 409	0.20	72.5	0	13 409
Niger*	1 700	0.05	0.0	0	1 700
Nigeria	47 998	0.13	73.2	0	47 998
Portuguese Guinea	429	0.07	0.0	0	429
Réunion	6 712	1.91	0.0	0	6 712
Rhodesia and Nyasaland:					
Northern Rhodesia	25 095	1.00	95.5	0	25 095
Nyasaland	5 637	0.19	88.8	0	5 637
Southern Rhodesia	84 088	2.63	88.3	0	84 088
Total	114 820	1.33	89.9	0	114 820
Rwanda	573	0.02	0.0	0	573
Sahara, Spanish*	300	1.20	0.0	0	300
St. Helena	132	2.64	0.0	0	132
São Tomé and Príncipe	396	0.58	73.2	0	396
Sénégal	22 378	0.75	75.0	0	22 378
Seychelles and Dependencies	230	0.52	100.0	230	0
Sierra Leone	4 610	0.18	76.1	46	4 564
Somalia	2 015	0.10	0.0	0	2 015
Somaliland, French	865	1.20	100.0	0	865
South Africa (7)	970 223	5.89	69.8	0	970 223
South West Africa	17 483	3.24	41.2	0	17 483
Spanish Equatorial Region	1 138	0.50	85.6	1 138	0
Spanish North Africa	7 782	5.02	100.0	7 782	0
Sudan	26 548	0.22	78.9	0	26 548
Swaziland	2 029	0.75	58.6	0	2 029
Tanganyika	16 238	0.17	73.8	0	16 238
Togo	2 256	0.15	75.3	0	2 256
Tunisia	27 866	0.65	55.7	0	27 866
Uganda	13 915	0.20	84.5	0	13 915
Upper Volta*	1 300	0.03	0.0	0	1 300
Zanzibar and Pemba	1 748	0.55	69.9	0	1 748
<b>ASIA</b>					
Aden Colony	5 864	—	100.0	0	5 864
Aden Protectorate	—	—	—	—	—
Afghanistan (6)	5 922	0.05	29.5	0	5 922
Bahrein	4 107	2.65	100.0	4 107	0
Bhutan	0	—	—	—	—

TABLE 3—Continued  
TELEPHONES BY COUNTRIES AS OF 1 JANUARY 1962—Continued

Country or Area	Number of Telephones	Per 100 Population	Percent Automatic	Telephones by Type of Operation (1)	
				Private	Government
Brunei	802	0.90	96.9	0	802
Burma	17 419	0.08	55.2	0	17 419
Cambodia	3 316	0.07	0.0	0	3 316
Ceylon	32 819	0.32	95.4	0	32 819
China, Mainland (6)	244 028	0.05	72.9	94 945	149 083
China, Taiwan	108 928	0.98	64.0	0	108 928
Cyprus	19 400	3.29	97.5	0	19 400
Hong Kong	128 535	3.98	100.0	128 535	0
India (7)	518 036	0.12	69.0	3 655	514 381
Indonesia	126 486	0.13	14.5	0	126 486
Iran*	139 800	0.67	75.0	0	139 800
Iraq (7)	54 434	0.76	85.6	0	54 434
Israel	132 429	5.93	97.5	0	132 429
Japan (7)	6 345 266	6.73	73.0	6 345 266	0
Jordan*	23 000	1.35	70.0	0	23 000
Korea, Republic of	121 671	0.47	56.0	0	121 671
Kuwait	15 293	4.75	100.0	1 835	13 458
Laos	795	0.04	51.6	0	795
Lebanon	68 530	4.06	94.4	0	68 530
Macao	2 589	1.17	100.0	0	2 589
Malaya	82 350	1.14	71.0	0	82 350
Maldivé Islands	0	—	—	—	—
Mongolia	9 391	0.96	68.9	0	9 391
Muscat and Oman	256	0.05	100.0	256	0
Nepál	2 500	0.03	40.0	0	2 500
North Borneo	3 825	0.82	99.5	0	3 825
Pakistan*	89 900	0.09	68.0	0	89 900
Philippine Republic	128 149	0.44	79.2	114 098	14 051
Portuguese Timor	486	0.09	0.0	0	486
Qatar	3 061	5.10	100.0	3 061	0
Ryukyu Islands (5)	11 454	1.28	73.1	0	11 454
Sarawak	5 080	0.67	77.8	0	5 080
Saudi Arabia (4)	28 600	0.42	40.0	0	28 600
Sikkim	0	—	—	—	—
Singapore	63 365	3.70	100.0	0	63 365
Syria	57 864	1.24	88.4	0	57 864
Thailand	48 247	0.17	82.8	0	48 247
Trucial Oman*	1 000	1.16	100.0	1 000	0
Viet-Nam, Republic of	17 008	0.12	81.2	0	17 008
West New Guinea	2 371	0.32	12.9	0	2 371
Yemen	0	—	—	—	—
OCEANIA					
Australia	2 322 900	21.92	80.0	0	2 322 900
British Solomon Islands	435	0.35	8.7	0	435
Canton Island	60	18.75	100.0	0	60
Caroline Islands	742	1.09	0.0	0	742
Christmas Island	78	2.60	100.0	78	0
Cocos (Keeling) Islands	63	6.30	100.0	0	63
Cook Islands	332	1.84	0.0	0	332
Fiji Islands	7 951	1.92	57.3	0	7 951
Gilbert and Ellice Islands	0	—	—	—	—
Guam	16 250	24.62	100.0	0	16 250
Mariana Islands (less Guam)	350	4.38	71.4	0	350
Marshall Islands	893	6.38	100.0	0	893
Midway Island	1 135	37.83	100.0	0	1 135
Nauru	0	—	—	—	—
New Caledonia and Dependencies	3 537	4.42	74.3	0	3 537
New Hebrides Condominium*	400	0.65	100.0	0	400
New Zealand (7)	801 875	32.37	72.8	0	801 875
Niue Island	96	1.92	0.0	0	96
Norfolk Island	35	4.12	0.0	0	35
Papua and New Guinea	6 446	0.32	80.0	0	6 446
Pitcairn Island	0	—	—	—	—
Polynesia, French	1 505	1.88	0.0	0	1 505
Samoa, American	500	2.38	100.0	0	500
Samoa, Western	983	0.86	0.0	0	983
Tokelau Islands	0	—	—	—	—
Tonga (Friendly) Islands	661	1.00	0.0	0	661
United States: Hawaii	255 562	37.47	100.0	255 562	0
Wake Island	160	12.80	100.0	0	160



TABLE 4  
TELEPHONE CONVERSATIONS DURING 1961

Country or Area	Thousands of Conversations			Average Conversations Per Person
	Local	Long Distance	Total	
Aden	7 353	2	7 355	35.0
Algeria	137 362	20 134	157 496	14.0
Angola	15 083	334	15 417	3.2
Argentina	4 015 767	50 523	4 066 290	192.9
Australia	1 729 000 (1)	77 000 (1)	1 806 000	171.9
Bahamas, West Indies	25 479	208	25 687	237.8
Barbados, West Indies	22 000	12	22 012	92.9
Belgium	637 128	136 986	774 114	84.1
Bermuda	16 500	30	16 530	330.6
Bolivia	48 883	319	49 202	14.1
Brazil	5 734 800	92 873	5 827 673	79.7
British Guiana	5 958	464	6 422	11.0
Cambodia	30 524	198	30 722	6.1
Canada	9 855 400	221 700	10 077 100	551.6
Ceylon	88 979	5 744	94 723	9.3
Channel Islands	17 482	878	18 360	166.9
Chile	521 127	20 193	541 320	69.4
China, Taiwan	371 898	13 549	385 447	35.1
Congo (Brazzaville)	4 254	251	4 505	5.0
Costa Rica	49 777	1 181	50 958	41.6
Cuba	635 062	10 335	645 397	94.3
Cyprus	19 336	2 104	21 440	36.9
Czechoslovakia	772 935	103 744	876 679	63.6
Denmark	1 180 429	270 001	1 450 430	311.9
Dominican Republic	78 180	372	78 552	25.4
El Salvador	52 560	10 643	63 203	25.3
Ethiopia	23 213	950	24 163	1.2
Fiji Islands	8 220	712	8 932	21.9
Germany, Democratic Republic	837 133	170 184	1 007 317	58.8
Germany, Federal Republic	3 648 702	1 216 139	4 864 841	86.2
Gibraltar	8 717	95	8 812	338.9
Ghana	20 430	17 684	38 114	5.5
Greece	603 695	14 482	618 177	73.7
Iceland	84 664	2 566	87 230	487.3
Ireland	145 540	14 474	160 014	56.8
Italy	5 834 611	522 723	6 357 334	128.3
Ivory Coast	7 100	303	7 403	2.2
Jamaica, West Indies	77 000	1 199	78 199	47.7
Japan	15 404 000 (2)	1 001 360	16 405 360	174.4
Korea, Republic of	881 681	9 069	890 750	35.1
Lebanon	101 000	15 000	116 000	69.0
Liechtenstein	1 785	1 740 (3)	3 525	207.4
Malagasy	9 235	1 200	10 435	1.9
Malaya	198 915	21 081	219 996	30.8
México	1 163 035	21 847	1 184 882	32.8
Morocco	107 425	9 207	116 632	9.8
Mozambique	16 997	680	17 677	2.7
Netherlands	1 096 387	503 830	1 600 217	137.5
Netherlands Antilles	28 621	27	28 648	147.7
New Caledonia	2 160	255	2 415	31.0
Nigeria	34 806	3 509	38 315	1.1
Norway	559 468	58 391	617 859	171.1
Papua and New Guinea	5 420	124	5 544	2.8
Peru	564 630	7 201	571 831	49.7
Philippine Republic	932 823	1 460	934 283	32.5
Portugal	474 652	51 076	525 728	57.2
Puerto Rico	161 816	5 406	167 222	69.5
Ryukyu Islands	29 849	1 413	31 262	35.1
Sarawak	9 300	685	9 985	13.2
Singapore	185 084	1 465	186 549	110.6
South Africa	1 174 907 (2)	80 702	1 255 609	77.2
South West Africa	14 688	2 256	16 944	31.7
Surinam	10 121	2 531	12 652	43.5
Sweden	2 424 000 (4)	353 800	2 777 800	368.3
Switzerland	693 014	627 030 (3)	1 320 044	241.3
Syria	90 182	4 430	94 612	20.5
Thailand	91 222	344	91 566	3.4

(1) Data reflect introduction of extended local service areas.  
 (2) Data are for year ended 31 March 1961.

(3) Three-minute units.  
 (4) Data are for the year ended 30 June 1962.

## World's Telephones—1962

TABLE 4—*Continued*  
TELEPHONE CONVERSATIONS DURING 1961—*Continued*

Country or Area	Thousands of Conversations			Average Conversations Per Person
	Local	Long Distance	Total	
Trinidad and Tobago, W. I.	97 640	8 002	105 642	123.0
Tunisia	23 498	5 657	29 155	6.9
Turkey	273 567	15 898	289 465	10.1
United Kingdom (2)	4 545 000	478 700	5 023 700	95.0
United States	93 790 000	3 555 000	97 345 000	529.7
Uruguay	381 000	7 386	388 386	135.4
Viet Nam, Republic of	20 247	325	20 572	1.4
Virgin Islands (U. S.)	6 842	73	6 915	209.5
Yugoslavia	440 712	34 101	474 813	25.2

## United States Patents Issued to International Telephone and Telegraph System; November 1962–April 1963

Between 1 November 1962 and 30 April 1963, the United States Patent Office issued 91 patents to the International System. The names of the inventors, company affiliations, subjects, and patent numbers are listed below.

P. R. Adams, R. S. Bovitz, G. B. Speen, and F. F. Hall, ITT Federal Laboratories, Accelerometer, 3 073 168.

R. T. Adams, ITT Federal Laboratories, Diversity Receiving System, 3 069 631.

R. T. Adams, ITT Federal Laboratories, Gyroscope, 3 080 762.

R. T. Adams and J. B. Harvey, ITT Federal Laboratories, Median Value Data Recorder, 3 066 297.

R. T. Adams and B. M. Mindes, Federal Telecommunication Laboratories, Magnetic Storage Systems, 3 069 664.

R. T. Adams and B. M. Mindes, ITT Federal Laboratories, Diversity Receiving System, 3 069 630.

H. H. Adelaar, Bell Telephone Manufacturing Company (Antwerp), Pulse Delay Circuit, 3 081 409.

T. E. Beling and E. R. Schwartz, ITT Federal Laboratories, Continuous Wave Moving Target Information Radar System, 3 081 455.

C. J. Beuscher, ITT Federal Laboratories, Method of Removing Hardened Photoresist Material from Printed Circuit Conductors, 3 081 203.

A. Braaten, Standard Telefon og Kabelfabrik (Oslo), Method and Machine for Making Cables, 3 073 104.

A. Braaten, W. Wilhelmsen, and J. N. Johnsen, Standard Telefon og Kabelfabrik (Oslo), Ring-Shaped Vessel for Drying and Impregnating Electrical Cables, 3 065 731.

A. E. Brewster, Standard Telecommunication Laboratories (London), Coders and Decoders for Pulse-Code-Modulation Systems, 3 069 641.

A. E. Brewster, Standard Telecommunication Laboratories (London), Electric Pulse Frequency Dividers, 3 087 073.

F. Buchwald, H. Fliegner, W. Kastenbein, and W. Sindzinski, Informatik Division of Standard Elektrik Lorenz (Stuttgart), Arrangement for the Sorting of Mail Items According to Size, 3 069 011.

W. E. Burch, ITT Components Division, Encapsulated Diode Assembly, 3 081 374.

F. A. Buuck, Farnsworth Electronics Company, Automatic Testing System and Timing Device Therefor, 3 082 374.

R. S. Caruthers, International Telephone and Telegraph Corporation, Single Side-Band Multichannel Carrier System, 3 082 296.

D. W. Casey II, S. J. Worley, and H. R. Meadows, Farnsworth Electronics Company, Attenuator Circuit, 3 075 140.

H. F. Castelijns, Bell Telephone Manufacturing Company (Antwerp), Vacuum Buffer, 3 065 892.

K. W. Cattermole, R. B. Herman, W. Bezel, and K. S. Darton, Standard Telecommunication Laboratories (London), Electric Pulse Modulating and Demodulating Circuits, 3 073 903.

F. L. Coombs, Purchased Invention, Electric Oscillators, 3 076 945.

C. L. Day, Farnsworth Electronics Company, Target Electrode for Barrier-Grid Storage Tube and Method of Making Same, 3 067 486.

K. L. DeBrosse, Farnsworth Electronics Company, Optical Search System, 3 087 986.

W. Dietrich, Standard Elektrik Lorenz (Stuttgart), Automatic Character-Recognition Method and Associated Arrangement of Apparatus, 3 081 444.

M. J. DiToro, Federal Telecommunication Laboratories, Decade Method of Noise Reduction, 3 081 457.

R. H. Duncan, ITT Kellogg, Quality Control Sorting Device, 3 082 871.

E. H. Eberhardt, ITT Federal Laboratories, Bolometers, 3 069 644.

S. J. Erst, ITT Federal Laboratories, Frequency-Modulated-Radar System Employing Two Sinusoidal Modulating Frequencies, 3 068 471.

L. G. Fischer, Federal Telecommunication Laboratories, Frequency Analysis and Measurement System, 3 066 257.

A. L. Fisher and E. S. McVey, Farnsworth Electronics Company, Automatic Rest-Frequency Control for Pulsed Frequency-Modulated Oscillator, 3 075 157.

G. Giesecke, Informatik Division of Standard Elektrik Lorenz (Stuttgart), Self-Clocking System for Reading Pulses Spaced at Variable Multiples of a Fixed Interval, 3 069 627.

D. S. Girling and C. J. Gilbert, Standard Telephones and Cables (London), Manufacture of Electrical Capacitors, 3 073 943.

F. Gray, C. Robinson, and R. Collins, Standard Telephones and Cables (London), Programme-Controlled Board-Piercing Equipment, 3 073 518.

L. B. Haigh, H. F. Herbig, and A. C. Bucarey, Federal Telecommunication Laboratories, Telephone Call Completion Indicator, 3 069 503.

E. S. Hawkins, ITT Federal Laboratories, System for Large-Area Display of Pictorial and Alpha-Numeric Information, 3 074 056.

J. F. Heney, ITT Federal Laboratories, Radio-Frequency Attenuator, 3 073 990.

H. F. Herbig and L. Medler, Federal Telecommunication Laboratories, Party-Line Subscriber Identifier, 3 073 905.

G. Hirschfeld, W. Hinz, and H. Fritzsche, Mix & Genest Werke (Stuttgart), Apparatus for Detecting Characteristic Markings, 3 069 653.

S. R. Hoh, ITT Federal Laboratories, Energy Converter, 3 073 974.

R. W. Hunter and I. K. Haak, ITT Federal Laboratories, Electron Discharge Device, 3 087 088.

R. W. Hutton, ITT Kellogg, Connector with Automatically Controlled Ringing, 3 085 133.

A. E. Karbowiak, Standard Telecommunication Laboratories (London), Electric-Waveguide Construction, 3 066 268.

F. S. Kasper and V. E. Porter, ITT Kellogg, A Computer, 3 067 936.

V. J. LeGendre, ITT Laboratories, Direct-Viewing Storage Tube, 3 066 234.

G. X. Lens and J. DePeuter, Bell Telephone Manufacturing Company (Antwerp), Mechanism for Transferring Flat Articles from a Transverse Conveyor to an Edgewise Conveyor, 3 068 988.

A. M. Levine, Federal Telecommunication Laboratories, Cooling System, 3 080 816.

S. W. Lewinter, Federal Telecommunication Laboratories, Pulse Communication System, 3 067 291.

T. F. Macall, Industrial Products Division, Automatic Light Intensity Compensator, 3 069 495.

A. J. Marino, Jr., Federal Telecommunication Laboratories, Method of Joining a Semiconductor to a Conductor, 3 065 534.

A. J. Marino and D. C. Seeley, ITT Federal Laboratories, Method and Means for Growing and Treating Crystals, 3 086 850.

B. McAdams, Federal Telecommunication Laboratories, Multichannel Communication System, 3 073 902.

G. H. Menhennett, ITT Federal Laboratories, Radial Resonant Cavities, 3 066 267.

- G. Merz and S. Ulmer, Mix & Genest Werke (Stuttgart), Method for the Reading-Out and Reading-In of Information Contained in a Ferrite-Core Storage Matrix, 3 066 281.
- F. Mittag, Mix & Genest Werke (Stuttgart), File Record Selection Arrangement, 3 073 313.
- H. A. Moore, Standard Telephones and Cables (London), Electric Submarine Cables, 3 073 889.
- J. Murgio, Federal Telecommunication Laboratories, Frequency-Difference Detector, 3 069 623.
- D. H. Owen, Standard Telephones and Cables (London), Manganese Ferrites, 3 066 103.
- E. M. Paulaitis and L. Lamin, ITT Kellogg, Conference Call Circuit, 3 083 265.
- A. J. Radcliffe, Jr., ITT Kellogg, Telephone Line Circuit, 3 082 297.
- A. J. Radcliffe, Jr., ITT Kellogg, Converter with Inductance Means for Sweeping Charge Carriers from Base Region, 3 081 437.
- A. Rappold, Schaub Apparatebau (Pforzheim), Means for Effecting Automatic Contrast Control in Television Receivers, 3 087 012.
- A. Rappold and H. Hein, Schaub Apparatebau (Pforzheim), Automatic-Frequency-Control Arrangement, 3 076 154.
- F. J. Raymond, Standard Telecommunication Laboratories (London), Production of Semiconductor Materials, 3 078 150.
- E. Reindl, Standard Telephon und Telegraphen (Vienna), Conveying System, 3 086 663.
- M. Ribner, ITT Kellogg, Pulse Coding System, 3 065 363.
- E. Richert, Standard Elektrik Lorenz (Stuttgart), Apparatus for Separating Flat Filed Articles, 3 086 770.
- E. Richert and R. Schneider, Mix & Genest Werke (Stuttgart), Equipment for Continually Charging an Edgewise Conveying System, 3 073 460.
- H. Salzmann, Mix & Genest Werke (Stuttgart), Arrangement for Leading Flat Dispatch Articles Round Corners in Conveying Systems, 3 080 956.
- C. P. Sandbank, Standard Telephones and Cables (London), Electron Discharge Devices, 3 066 236.
- U. Schottle and G. Reinicke, Standard Elektrik Lorenz (Stuttgart), Cash-Register Safeguard for Use in a System for Automatically Controlling the Movement of Goods, 3 072 324.
- G. H. Servos, ITT Kellogg, Dielectric-Testing Device, 3 069 620.
- S. B. Silverschotz, ITT Federal Laboratories, Ice Detector, 3 086 393.
- S. M. Simon, Bell Telephone Manufacturing Company (Antwerp), Electrical Trigger Circuit, 3 081 419.
- S. Simon and E. deRaedt, Bell Telephone Manufacturing Company (Antwerp), Test Device for Telecommunication Systems, 3 079 465.
- W. R. Sloan, ITT Federal Laboratories, System for Large-Area Display of Two-Color Information, 3 069 681.
- T. R. Spalding, Capehart-Farnsworth Corporation, Apparatus for Detecting Hot Journal Boxes, 3 076 089.
- G. B. Speen, ITT Federal Laboratories, Accelerometer, 3 080 761.
- K. Steinbuch, Mix & Genest Werke (Stuttgart), Automatic Character-Recognition Method, 3 066 224.
- K. Steinbuch, Mix & Genest Werke (Stuttgart), Method for the Automatic Recognition of Characters, 3 088 096.
- K. Steinbuch and H. Endres, Mix & Genest Werke (Stuttgart), Automatic Character-Recognition Method, 3 069 079.
- K. Steinbuch and H. Endres, Mix & Genest Werke (Stuttgart), Postage Stamp Detecting Circuit Arrangement, 3 087 141.

K. Steinbuch, H. Endres, and U. Zorll, Mix & Genest Werke (Stuttgart), Evaluation of Characters, 3 088 097.

K. Steinbuch and H. Reiner, Mix & Genest Werke (Stuttgart), Cryogenic Bistable Device, 3 081 406.

H. F. Sterling, Standard Telecommunication Laboratories (London), Production of Silicon, 3 069 244.

H. F. Sterling and F. J. Raymond, Standard Telecommunication Laboratories (London), Manufacture of High-Purity Silicon, 3 069 241.

J. E. J. G. Toussaint, Bell Telephone Manufacturing Company (Antwerp), Decoding and Printing System, 3 081 446.

T. W. Tuttle and G. F. McCarthy, ITT Federal Laboratories, Step-by-Step Switch, 3 081 416.

R. R. Waer, Federal Telecommunication Laboratories, Continuous Wave Radar With PPI Type Display, 3 081 456.

E. P. G. Wright, Standard Telecommunication Laboratories (London), Serial Number Issuing Equipment, 3 081 451.

E. P. G. Wright, D. S. Ridler, and W. Bezdell, Standard Telecommunication Laboratories (London), Intelligence Storage Equipment, 3 081 448.

E. P. G. Wright, D. S. Ridler, and A. Odell, Standard Telephones and Cables (London), Storage of Electrical Information, 3 069 660.

#### **Method for the Automatic Recognition of Characters**

3 088 096

K. Steinbuch

This patent discloses a character-recognition system having a resistor network with a fixed voltage at its periphery. An image of the character is projected onto the network developing

different potentials at resistor intersections. Potential gradients produced by these voltages are evaluated to provide an unambiguous indication of the character.

#### **Single Side-Band Multichannel Carrier System**

3 082 296

R. S. Caruthers

This is a system for doubling the channel capacity of a single-sideband system of the type in which the single-sideband wave is produced by combining the outputs of two modulators with a 90-degree phase difference in both the carrier and input signal waves. To accomplish this, two signal channels for each direction of transmission are coupled over a hybrid circuit to modulators connected to the terminals of this circuit opposite to the signal coupling terminals.

#### **Electric Pulse Modulating and Demodulating Circuits**

3 073 903

K. W. Cattermole, R. B. Herman, W. Bezdell, and K. S. Darton

This is a two-direction pulse translating arrangement of the resonant transfer type. The reactive storage unit serves as the transfer between a local circuit and a pulse line circuit. It is coupled by a transistor in such a manner that keying pulses applied thereto cause the storage unit to discharge energy received from one circuit into the other circuit.

#### **Energy Converter**

3 073 974

S. R. Hoh

Heat energy is converted directly into usable electric energy by a capacitor having a dielectric such as barium titanate in which the dielectric

constant varies with temperature. The capacitor is charged at a given voltage and temperature. The temperature is then changed and energy is extracted at a different voltage, after which the temperature is returned to its initial condition.

#### **Automatic Character-Recognition Method**

3 069 079

K. Steinbuch and H. Endres

A character-recognition system is described in which the character to be recognized is stored in simulated form in a two-dimensional storage array. The storage array is in the form of a shift register so that the simulated character can be shifted for centering. The recognition of the character is accomplished by the actuation of suitably arranged coincidence gates.

#### **Electric Submarine Cables**

3 073 889

H. A. Moore

To avoid difficulties encountered in covering a submarine cable by extrusion of a sheath, a length of copper tape is wrapped around the stranded core and the edges of the tape are

formed into a box seam that is sealed by a length of plastic material inside the sheath.

#### **Ring-Shaped Vessel for Drying and Impregnating Electrical Cables**

3 065 731

A. Braaten, W. Wilhelmssen, and J. N. Johnsen

To provide for drying and oil-impregnating long lengths of cable while maintaining a large radius of bend, a vessel is provided in a ring form. This gives a smaller volume to evacuate than would otherwise be needed. To permit the impregnated cable core to be paid out to a sheathing extruder, the outer wall of the vessel is stationary while the cable-carrying part is rotatable.

#### **Electric-Waveguide Construction**

3 066 268

A. E. Karbowiak

In a waveguide transmission system, the interior of a circular waveguide is coated with a low-loss dielectric to allow a reduction in the permissible radius of curvature without introducing mode conversion.

# International Telephone and Telegraph Corporation

## Principal Divisions and Subsidiaries

### NORTH AMERICA

#### MANUFACTURING—SALES —SERVICE

##### Canada

ITT Canada Limited, Montreal  
Royal Electric Company (Quebec) Ltd., Pointe Claire, P.Q.

##### Jamaica

ITT Standard Electric of Jamaica Ltd., Kingston

##### Mexico

Industria de Telecomunicación, S. A. de C. V. (50% interest), Mexico City  
Standard Eléctrica de México, S. A., Mexico City

##### Panama

ITT Standard Electric de Panamá, S. A., Panama City

##### Puerto Rico

ITT Caribbean Manufacturing, Inc., Rio Piedras  
ITT Caribbean Sales and Service, Inc., Rio Piedras  
ITT Puerto Rico, Inc., Rio Piedras

##### United States of America

Federal Electric Corporation, Paramus, N. J.  
Intelix Systems Incorporated, Paramus, N. J.  
International Standard Engineering, Inc., Paramus, N. J.  
Industrial Products Division, San Fernando, Calif.  
ITT Mobile Telephone, Inc., San Fernando, Calif.  
International Standard Electric Corporation, New York, N. Y.  
International Telephone and Telegraph Corporation, Sud America, New York, N. Y.  
International Telephone and Telegraph Credit Corporation, New York, N. Y.  
ITT Arkansas Division, Camden, Ark.  
ITT Bell & Gossett, Inc., Morton Grove, Ill.  
ITT Cannon Electric Inc., Los Angeles, Calif.  
ITT Communication Systems, Inc., Paramus, N. J.  
ITT Data and Information Systems Division, Paramus, N. J.  
Airmatic Systems Corporation, Saddle Brook, N. J.  
ITT Electron Tube Division, Clifton, N. J.  
ITT Export Corporation, New York, N. Y.  
ITT Farnsworth Research Corporation, Fort Wayne, Ind.

ITT Federal Laboratories, Nutley, N. J.  
ITT General Controls Inc., Glendale, Calif.  
ITT Gilfillan Inc., Los Angeles, Calif.  
ITT Industrial Laboratories Division, Fort Wayne, Ind.  
ITT Intelcom Inc., Falls Church, Va.  
ITT Kellogg Communications Systems, Chicago, Ill.  
ITT Kellogg Telecommunications, Chicago, Ill.  
ITT Nesbitt Inc., Philadelphia, Pa.  
ITT Semi-Conductors, Inc., Lawrence, Mass.  
National Transistor, Lawrence, Mass.  
ITT Surprenant Inc., Clinton, Mass.  
Jennings Radio Manufacturing Corporation, San Jose, Calif.  
Kellogg Credit Corporation, New York, N. Y.  
Royal Electric Corporation, Pawtucket, R. I.

#### TELECOMMUNICATION OPERATIONS

##### Canal Zone

ITT Central America Cables & Radio, Inc., Balboa

##### Cuba

Cuban American Telephone and Telegraph Company (50% interest), Havana  
Radio Corporation of Cuba, Havana

##### Puerto Rico

Puerto Rico Telephone Company, San Juan  
Radio Corporation of Puerto Rico, San Juan

##### Virgin Islands

ITT Communications, Inc.—Virgin Islands, Charlotte Amalie  
Virgin Islands Telephone Corporation, Charlotte Amalie

### SOUTH AMERICA

#### MANUFACTURING—SALES —SERVICE

##### Argentina

Compañía Standard Electric Argentina, S.A.I.C., Buenos Aires

##### Brazil

Standard Eléctrica, S.A., Rio de Janeiro

##### Chile

Compañía Standard Electric, S.A.C., Santiago

##### Colombia

ITT Standard de Colombia, S.A., Bogotá

##### Venezuela

Standard Telecommunications C.A., Caracas

#### TELECOMMUNICATION OPERATIONS

##### Argentina

Compañía Internacional de Radio, S.A., Buenos Aires

##### Bolivia

Compañía Internacional de Radio Boliviana, La Paz

##### Brazil

Companhia Rádio Internacional do Brasil, Rio de Janeiro  
Companhia Telefônica Nacional, Curitiba

##### Chile

Compañía de Teléfonos de Chile, Santiago  
Compañía Internacional de Radio, S.A., Santiago

##### Peru

Compañía Peruana de Teléfonos Limitada, Lima

### EUROPE, MIDDLE EAST, AFRICA

#### MANUFACTURING—SALES —SERVICE

##### Algeria

Société Algérienne de Constructions Téléphoniques, Algiers

##### Austria

Standard Telephon und Telegraphen Aktiengesellschaft, Czeija, Nissl & Co., Vienna

##### Belgium

Bell Telephone Manufacturing Company, Antwerp  
ITT Europe, Inc., Brussels  
ITT Industries, Europe Inc., Brussels  
ITT Standard S. A., (branch), Brussels

##### Denmark

Standard Electric Aktieselskab, Copenhagen

##### Finland

Standard Electric Puhelinteollisuus Oy, Helsinki

##### France

Compagnie Générale de Constructions Téléphoniques, Paris  
Les Téléimprimeurs, Paris



## International Telephone and Telegraph Corporation

International Standard Engineering, Inc. (branch), Paris  
 Laboratoire Central de Télécommunications, Paris  
 Le Matériel Téléphonique, Paris  
 Société Industrielle de Composants pour l'Electronique, Courbevoie

### Germany (West)

Standard Elektrik Lorenz Aktiengesellschaft, Stuttgart  
 Graetz Kommanditgesellschaft, Altena  
 SEL Feinmechanik G.m.b.H., Kaufbeuren  
 SEL Finanz G.m.b.H., Stuttgart  
 Eduard Winkler Apparatebau G.m.b.H., Nuremberg

### Iran

Standard Electric Iran AG, Tehran

### Italy

Fabbrica Apparecchiature per Comunicazioni Elettriche Standard S.p.A., Milan  
 Società Impianti Elettrici Telefonici Telegrafici E Costruzioni Edili S.p.A., Florence  
 ITT Domel Italiana S.p.A., Milan

### Netherlands

Nederlandsche Standard Electric Maatschappij N.V., The Hague  
 Internationale Luchtvaart Radio-service N.V., Rotterdam

### Norway

Standard Telefon og Kabelfabrik A/S, Oslo

### Portugal

Standard Eléctrica, S.A.R.L., Lisbon

### Republic of South Africa

Standard Telephones and Cables (South Africa) (Proprietary) Limited, Boksburg East, Transvaal

### Spain

Compañía Internacional de Telecomunicación y Electronica, S.A., Madrid

Compañía Radio Aérea Marítima Española, S.A., Madrid  
 Standard Eléctrica, S.A., Madrid

### Sweden

Standard Radio & Telefon AB, Bromma (Stockholm)

### Switzerland

ITT Standard S.A., Basle  
 Standard Téléphone et Radio S.A., Zurich  
 Steiner S.A., Berne

### Turkey

Standard Elektrik ve Telekomünikasyon Limited Şirketi, Ankara

### United Kingdom

Creed & Company Limited, Croydon  
 Standard Telephones and Cables Limited, London  
 Ace Radio Limited, Rhyl (Wales)  
 P. X. Fox Limited, London  
 Hudson Electronic Devices Limited, Footscray  
 International Marine Radio Company, Croydon  
 Kolster-Brandes Limited, Sidcup  
 Robert Maclaren & Co. Ltd., Glasgow  
 Regentone Products Limited, London  
 Standard Telecommunication Laboratories Limited, London  
 Stanelco Industrial Services Ltd., London

## FAR EAST AND PACIFIC MANUFACTURING—SALES—SERVICE

### Australia

Standard Telephones and Cables Pty. Limited, Sydney

### Hong Kong

ITT Far East and Pacific, Inc., Hong Kong  
 ITT Far East Ltd., Hong Kong

### Japan

ITT Far East and Pacific, Inc. (branch), Tokyo

### New Zealand

Standard Telephones and Cables Pty. Limited (branch), Upper Hutt, Wellington

### Philippines

ITT Philippines, Incorporated, Makati, Rizal

## WORLDWIDE CABLE AND RADIO TELEGRAPH OPERATIONS

American Cable & Radio Corporation, New York  
 All America Cables and Radio, Inc., New York  
 Commercial Cable Company, The, New York  
 Globe Wireless Ltd., New York  
 ITT Central America Cables & Radio, Inc., Balboa, C. Z.  
 ITT Communications, Inc.—Virgin Islands, Charlotte Amalie  
 Mackay Radio and Telegraph Company, New York  
 Radio Corporation of Puerto Rico, San Juan

## ASSOCIATE LICENSEES FOR MANUFACTURING (MINORITY INTEREST)

### Australia

Austral Standard Cables Pty. Limited, Melbourne

### France

Lignes Télégraphiques et Téléphoniques, Paris

### Italy

Società Italiana Reti Telefoniche Interurbane, Milan

### Japan

Nippon Electric Company, Limited, Tokyo  
 Sumitomo Electric Industries, Limited, Osaka

### Spain

Marconi Española, S.A., Madrid

---

## THE WORLD OF ITT

---

### North America\*

40,000 employees  
 9,100,000 square feet

### Europe, Middle East, Africa

115,000 employees  
 20,600,000 square feet

### South America

15,000 employees  
 1,400,000 square feet

### Far East and Pacific

3,000 employees  
 800,000 square feet

### Totals

173,000 employees  
 31,900,000 square feet

Sales representatives in most countries

\* Includes Central America and Caribbean

**Ministac—a Versatile Method for Constructing Component Assemblies**  
**Standard Equipment Practice for ITT Europe**  
**Central Testing Organization Within ITT Europe**  
**Speech Immunity of Push-Button Tone Signaling Systems Employing Tone Receivers**  
**with Guard Circuits**  
**Quasi-Electronic Telephone Switching System HE-60**  
**Harmonic Absorbing Filters in Waveguide**  
**Evolution of Telephone, Telegraph, and Telex Traffic**  
**Spectral Matrix for Analysis of Time-Varying Networks**  
**Coded-Linear-Array Antenna**  
**Choice of a Telephone Switching System**

**VOLUME 39 • NUMBER 2 • 1964**